

# MÜLLER LICHT

LAMPEN & LEUCHTEN  
HÄNDLERINFORMATION

LAMPES & LUMIERES · INFORMATIONS POUR LE REVENDEUR

LAMPS & LUMINAIRES · TRADER INFORMATION

## DER NEUE LICHTKOMFORT

LE NOUVEAU CONFORT LUMINEUX  
THE NEW LIGHTING COMFORT



## INHALTSVERZEICHNIS

TABLE DES MATIERES

TABLE OF CONTENTS

### ÜBER UNS

A PROPOS DE NOUS  
ABOUT US

3

### LAMPENSORTIMENT

GAMME DE LAMPES  
LAMP ASSORTMENT

4

### LED-ACCESSOIRES

ACCESSOIRES LED  
LED ACCESSORIES

30

### LEUCHTENSORTIMENT

GAMME DE LUMIERES  
LUMINAIRE ASSORTMENT

54

### POS-KOMMUNIKATION

COMMUNICATION EN MAGASIN  
POS COMMUNICATION

86

### ZWEITPLATZIERUNGEN

PRESENTOIRS SECONDAIRES  
SECONDARY DISPLAYS

88

### INFORMATIONEN, LEGENDE

INFORMATIONS, LEGENDE  
INFORMATION, LEGEND

90

#### RENFORCER DURABLEMENT LE C.A. AVEC LES SYSTEMES MÜLLER-LICHT

##### Une gamme convaincante au meilleur prix

Qu'il s'agisse de lampes, lumières ou accessoires LED, MÜLLER-LICHT saura vous convaincre grâce à sa vaste gamme de solutions de qualité proposée au meilleur prix. Nous sommes spécialisés dans l'intégration de techniques LED à faible consommation et durables dans toute la gamme de produits.

##### Une communication attrayante en magasin

La gamme de solutions MÜLLER-LICHT s'accompagne de nouveaux supports de vente très attrayants et pertinents. Des emballages faciles à comprendre par les clients aux conseils simples et ciblés dans les rayons, cette communication vous aidera à mieux vendre! Découvrez aussi l'offre MÜLLER-LICHT en ligne: vous trouverez, sur notre nouveau site Internet [www.mueller-licht.de](http://www.mueller-licht.de), toutes les dernières informations disponibles.

##### La promesse de la Direction: collaborer pour réussir

«En tant que PME, nous sommes très flexibles et pouvons réagir à vos attentes et besoins particuliers, en vous offrant des produits et concepts de vente parfaitement adaptés à chaque situation. Nous vous proposons donc tout naturellement un service complet, des voies de communication simples et rapides ainsi qu'un suivi personnel et fiable. Trouver la bonne lumière pour tous, voici notre leitmotiv – celui de l'équipe de MÜLLER LICHT!», précise Navid Sanatgar, au nom de la Direction.

#### PERMANENTLY INCREASE SALES WITH MÜLLER-LICHT

##### Impressive assortment at the best price

When it comes to lamps, luminaires or LED accessories: MÜLLER-LICHT has an impressively wide assortment of high quality products with the best price-performance ratio. Our focus lies in the integration of energy-saving and sustainable LED technology in the entire product assortment.

##### Sales-promoting communication at the POS

The MÜLLER-LICHT assortment is supported by a newly developed sales-promoting POS appearance. Starting with consumer-friendly packaging and clearly structured and easy customer guidance at the shelf, MÜLLER-LICHT gives you optimal support for your sales activities. MÜLLER-LICHT can also be experienced digitally: On our new website [www.mueller-licht.de](http://www.mueller-licht.de) you can always find the latest information

##### The promise of the management: Partnership for success

„As a medium-sized company, we have the flexibility and capability of reacting to your individual wishes and requirements and can offer product and sales concepts that are ideally matched to your situation. In doing so, we consider comprehensive service, uncomplicated and direct communication paths and personal, honest contact to be a matter of course. Good lighting for all is what we stand for – the MÜLLER-LICHT TEAM!“ said Navid Sanatgar on behalf of the management.



## UMSÄTZE MIT MÜLLER-LICHT NACHHALTIG STEIGERN

### **Überzeugendes Sortiment zum besten Preis**

Egal ob Lampe, Leuchte oder LED-Accessoire: MÜLLER-LICHT überzeugt mit seinem breiten Sortiment an qualitativ hochwertigen Produkten zum besten Preis-Leistungs-Verhältnis. Unser Schwerpunkt liegt hierbei auf der Integration energiesparender und nachhaltiger LED-Technik im gesamten Produktportfolio.

### **Verkaufsaktive Kommunikation am POS**

Unterstützt wird das MÜLLER-LICHT Sortiment durch einen neu entwickelten, verkaufsaktiven POS-Auftritt. Angefangen bei verbraucherfreundlich gestalteten Verpackungen bis hin zur übersichtlichen und damit einfachen Kundenführung am Regal, MÜLLER-LICHT unterstützt Sie optimal in Ihren Abverkäufen.

Erleben Sie MÜLLER-LICHT außerdem auch digital: Auf unserer neuen Website [www.mueller-licht.de](http://www.mueller-licht.de) finden Sie immer die aktuellsten Informationen.

### **Das Versprechen der Geschäftsführung: Partnerschaftlich zum Erfolg**

„Als mittelständisches Unternehmen besitzen wir die Flexibilität und die Möglichkeiten, auf Ihre individuellen Wünsche und Bedürfnisse zu reagieren und speziell auf Ihre Situation abgestimmte Produkt- und Verkaufskonzepte anzubieten. Dabei sind für uns ein ganzheitlicher Service, unkomplizierte und schnelle Wege, sowie ein persönlicher und vertrauensvoller Kontakt selbstverständlich. Gutes Licht für alle, dafür stehen wir – das TEAM von MÜLLER-LICHT!“, so Navid Sanatgar, im Namen der Geschäftsführung.

MÜLLER  
LICHT



Unser Lampensortiment

# FÜR JEDE SITUATION DAS RICHTIGE LICHT

Notre gamme de lampes

LA BONNE LUMIERE POUR CHAQUE SITUATION

Our lamp assortment

THE RIGHT LIGHTING FOR EVERY SITUATION

## LED-LAMPEN

LAMPES LED  
LED LAMPS

6

## HALOGENLAMPEN

LAMPES HALOGENE  
HALOGEN LAMPS

20

## ALLGEBRAUCHSLAMPEN

LAMPES POLYVALENTES  
INCANDESCENT LAMPS

26

## LEUCHTSTOFFLAMPEN

LAMPES FLUORESCENTES  
FLUORESCENT LAMPS

28





## LED-VIELFALT FÜR SIE UND IHRE KUNDEN

Die LED-Technik ist aus der modernen Lichtwelt nicht mehr wegzudenken. Unsere LED-Lampen stehen für eine lange Lebensdauer und eine hohe Energieersparnis bei gleichzeitig moderner Optik. Mit MÜLLER-LICHT bieten Sie Ihren Kunden ein umfassendes und qualitativ hochwertiges LED-Sortiment zum guten Preis.

### UNE GRANDE DIVERSITE DE LED POUR VOUS ET VOS CLIENTS

La technique LED fait aujourd'hui partie intégrante du monde moderne des lumières. Nos lampes LED sont synonymes de longue durée de vie et de faible consommation d'énergie, tout en vous garantissant un style tendance. Avec MÜLLER-LICHT, vous proposez à vos clients une gamme très complète et de solutions LED de qualité au meilleur prix.

### LED DIVERSITY FOR YOU AND YOUR CUSTOMERS

LED technology has now become an essential part of the modern world of lighting. Our LED lamps provide a long service life and high energy savings with a modern appearance. With MÜLLER-LICHT you offer your customers a comprehensive and high-quality LED assortment at a good price.

## Birnen / Forme standard / Bulbs



1	400007	Birne / Forme standard / Bulb
1	400015	Birne / Forme standard / Bulb
1	400010	Birne / Forme standard / Bulb
1	400014	Birne / Forme standard / Bulb
2	400011	Birne / Forme standard / Bulb
2	400004	Birne / Forme standard / Bulb
3	400221	Birne / Forme standard / Bulb

## Kerzen / Flammes / Candles



1	400017	Kerze / Flamme / Candle
1	400022	Kerze / Flamme / Candle
1	400023	Kerze / Flamme / Candle
2	400020	Kerze / Flamme / Candle

## Globes / Globes / Globes



1	400032	Miniglobe / Mini globe / Mini Globe
1	400028	Miniglobe / Mini globe / Mini Globe
1	400039	Miniglobe / Mini globe / Mini Globe
2	400026	Miniglobe / Mini globe / Mini Globe
3	400049	Globe / Globe / Globe
4	400050	Globe / Globe / Globe







## Reflektoren / Réflecteurs / Reflectors



1	400053	Reflektor / Réflecteur / Reflector
2	400054	Reflektor / Réflecteur / Reflector
2	400056	Reflektor / Réflecteur / Reflector
3	400128	Reflektor / Réflecteur / Reflector
3	400129	Reflektor / Réflecteur / Reflector
4	400060	Reflektor / Réflecteur / Reflector
5	400061	Reflektor / Réflecteur / Reflector
6	400130	Reflektor / Réflecteur / Reflector
7	400063	Reflektor / Réflecteur / Reflector

**3** Jahre Garantie  
ans garantie  
years warranty  
[www.mueller-licht.de/garantie](http://www.mueller-licht.de/garantie)

Unsere exklusiven HD-LED Produkte finden Sie auf Seite 12.  
Vous trouverez nos produits exclusifs HD-LED page 12.  
Our exclusive HD-LED products can be found on page 12.

	<b>W</b>		<b>lm</b>	<b>Ra</b>			<b>V</b>	<b>K</b>					
E27	5,5	40	470	≥ 80	200	A+	220-240	2700	-	60 x 109	1/BLI	4	25.000
E27	7	40	470	≥ 80	200	A+	230	2700	✓	60 x 110	1/BLI	4	25.000
E27	10	60	810	≥ 80	200	A+	220-240	2700	-	60 x 109	1/BLI	4	25.000
E27	10	60	810	≥ 80	200	A+	220-240	2700	✓	60 x 110	1/BLI	4	25.000
E27	12	75	1055	≥ 80	200	A+	220-240	2700	-	60 x 120	1/BLI	4	25.000
E27	13	75	1055	≥ 80	200	A+	220-240	2700	✓	60 x 120	1/BLI	4	25.000
E27	12	100	1520	≥ 80	200	A++	220-240	2700	-	65 x 134	1/BLI	4	25.000
E14	3	25	250	≥ 80	180	A+	220-240	2700	-	38 x 108	1/BLI	7	25.000
E14	5,5	40	470	≥ 80	180	A+	220-240	2700	✓	37 x 103	1/BLI	7	25.000
E14	5,5	40	470	≥ 80	180	A+	220-240	2700	-	37 x 100	1/BLI	7	25.000
E14	4,5	30	320	≥ 80	180	A+	220-240	2700	-	35 x 101	1/BLI	7	25.000
E14	3	25	250	≥ 80	180	A+	220-240	2700	-	45 x 79	1/BLI	7	25.000
E14	5,5	40	470	≥ 80	180	A+	220-240	2700	✓	45 x 81	1/BLI	7	25.000
E14	5,5	40	470	≥ 80	180	A+	220-240	2700	-	45 x 81	1/BLI	7	25.000
E27	3	25	250	≥ 80	180	A+	220-240	2700	-	45 x 75	1/BLI	7	25.000
E27	9	60	806	≥ 80	200	A+	220-240	2700	✓	95 x 142	1/BOX	4	25.000
E27	11	75	1055	≥ 80	200	A+	220-240	2700	✓	120 x 164	1/BOX	4	25.000
GU10	3	-	230	≥ 80	> 120 <sup>1</sup>	A+	220-240	2700	-	50 x 55	1	6	25.000
GU10	5	> 50	320	≥ 80	36	A+	220-240	2700	-	50 x 55	1	6	25.000
GU10	5	> 50	320	≥ 80	32	A+	220-240	2700	✓	50 x 55	1	6	25.000
GU10	7	> 50	500	≥ 80	40	A+	220-240	2700	-	50 x 55	1	6	25.000
GU10	7	> 50	450	≥ 80	40	A+	220-240	2700	✓	50 x 55	1	6	25.000
GU5.3	3	-	230	≥ 80	> 120 <sup>1</sup>	A+	12	2700	-	50 x 50	1	6	25.000
GU5.3	5	33	320	≥ 80	38	A+	12	2700	-	50 x 47	1	6	25.000
GU5.3	7,5	41	450	≥ 80	38	A	12	2700	-	50 x 47	1	6	25.000
GU4	3	24	220	≥ 80	30	A++	12	2700	-	35 x 41	1	7	25.000

Eine Dimmerliste finden Sie auf unserer Website unter:

Vous trouverez sur notre site Internet une liste des variateurs:

A list of dimmers can be found on our website under:

[www.mueller-licht.de/dimmer](http://www.mueller-licht.de/dimmer)

<sup>1</sup> Messung nicht nach Halbwertswinkeln.

<sup>1</sup> Mesure prise sans les angles moyens.

<sup>1</sup> Measurement not to half-angles.



## Reflektoren / Réflecteurs / Reflectors

					
1	2	3	4	5	6
1	400068	Reflektor / Réflecteur / Reflector <b>R39</b>			
	2	400065	Reflektor / Réflecteur / Reflector <b>PAR16</b>		
	3	400069	Reflektor / Réflecteur / Reflector <b>R50</b>		
	4	400067	Reflektor / Réflecteur / Reflector <b>R63</b>		
	5	400159	Reflektor / Réflecteur / Reflector <b>R80</b>		
	6	400066	Reflektor / Réflecteur / Reflector <b>PAR38</b>		

## Spezial / Spécifique / Special

						
1	2	3	4	5	6	7
	1	400046	Kühlschranklampe / Réfrigérateurs / Refrigerator lamp			
	2	400042	Niedervolt-Stiftsockel / Capsule basse tension / Low voltage capsule			
	3	400043	Hochvolt-Stiftsockel / Capsule haute tension / Main voltage capsule			
	4	400134	Hochvolt-Stiftsockel / Capsule haute tension / Main voltage capsule			
	5	400044	GX53 / GX53 / GX53			
	5	400045	GX53 / GX53 / GX53			
	6	400173	R7s / R7s / R7s			
	7	400174	R7s / R7s / R7s			
	8	20600147	S19 / S19 / S19			

## LED-Röhren<sup>2</sup> / Tubes à LED<sup>2</sup> / LED tubes<sup>2</sup>

		
1	2	3
1	400107	Röhre / Tube / Tube <b>600 mm</b>
1	400108	Röhre / Tube / Tube <b>600 mm</b>
1	400115	Röhre / Tube / Tube <b>600 mm</b>
2	400114	Röhre / Tube / Tube <b>1200 mm</b>
2	400109	Röhre / Tube / Tube <b>1200 mm</b>
2	400116	Röhre / Tube / Tube <b>1200 mm</b>
3	400110	Röhre / Tube / Tube <b>1500 mm</b>
3	400111	Röhre / Tube / Tube <b>1500 mm</b>
3	400113	Röhre / Tube / Tube <b>1500 mm</b>
3	400155	Röhre / Tube / Tube <b>1500 mm</b>
3	400156	Röhre / Tube / Tube <b>1500 mm</b>
3	400157	Röhre / Tube / Tube <b>1500 mm</b>

**3** Jahre Garantie  
ans garantie  
years warranty  
[www.mueller-licht.de/garantie](http://www.mueller-licht.de/garantie)

	☰	W	💡	lm	Ra	◡	📄	V	K	🌙	📏	💡/Blister	📦	🕒
E14	3	21	200	≥ 80	> 120 <sup>1</sup>	A+	220-240	2700	-	39 x 70	1/BLI	7	25.000	
E14	5	> 50	320	≥ 80	38	A+	220-240	2700	-	50 x 75	1/BLI	6	25.000	
E14	6	40	430	≥ 80	> 120 <sup>1</sup>	A+	220-240	2700	-	50 x 86	1/BLI	6	25.000	
E27	8	44	530	≥ 80	> 120 <sup>1</sup>	A+	220-240	2700	-	63 x 100	1/BLI	5	25.000	
E27	13	75	1000	≥ 80	> 120 <sup>1</sup>	A+	220-240	2700	-	80 x 110	1/BLI	3	25.000	
E27	15	75	1000	≥ 80	38 <sup>1</sup>	A	220-240	2700	-	120 x 132	1/BOX	10	30.000	

	☰	W	💡	lm	Ra	◡	📄	V	K	🌙	📏	💡/Blister	📦	🕒
E14	1	10	75	≥ 80	120	A++	220-240	2700	-	25 x 60	1/BLI	10	25.000	
G4	1,2	8	70	≥ 80	110	A+	12	2700	-	10 x 32	1/BLI	10	25.000	
G9	1,9	17	150	≥ 80	150	A+	220-240	2700	-	16 x 46	1/BLI	8	25.000	
G9	3	25	230	≥ 80	270	A+	220-240	2700	-	18 x 50	1/BLI	8	25.000	
GX53	6	-	450	≥ 80	> 120 <sup>1</sup>	A+	220-240	2700	-	75 x 25	1/BLI	10	25.000	
GX53	6	-	450	≥ 80	> 120 <sup>1</sup>	A+	220-240	4000	-	75 x 25	1/BLI	10	25.000	
R7s	4,5	-	420	≥ 80	360 <sup>1</sup>	A+	220-240	2700	-	24 x 78	1/BLI	6	15.000	
R7s	8	-	730	≥ 80	360 <sup>1</sup>	A+	220-240	2700	-	24 x 118	1/BLI	6	15.000	
S19	5	-	500	≥ 80	360 <sup>1</sup>	A++	220-240	3000	-	29 x 309	1/BLI	5	25.000	

	☰	W	💡	lm	Ra	◡	📄	V	K	🌙	📏	💡/Blister	📦	🕒
G13	10	-	900	≥ 80	150	A+	220-240	3000	-	28 x 600	1/BOX	5	25.000	
G13	10	-	950	≥ 80	150	A+	220-240	4000	-	28 x 600	1/BOX	5	25.000	
G13	10	-	1000	≥ 80	150	A+	220-240	6500	-	28 x 600	1/BOX	5	25.000	
G13	18	-	1700	≥ 80	150	A+	220-240	3000	-	28 x 1200	1/BOX	5	25.000	
G13	18	-	1800	≥ 80	150	A+	220-240	4000	-	28 x 1200	1/BOX	5	25.000	
G13	18	-	1900	≥ 80	150	A+	220-240	6500	-	28 x 1200	1/BOX	5	25.000	
G13	22	-	2000	≥ 80	150	A+	220-240	3000	-	28 x 1500	1/BOX	5	25.000	
G13	22	-	2100	≥ 80	150	A+	220-240	4000	-	28 x 1500	1/BOX	5	25.000	
G13	22	-	2300	≥ 80	150	A+	220-240	6500	-	28 x 1500	1/BOX	5	25.000	
G13	24	-	2700	≥ 80	120	A+	230	3000	-	28 x 1500	1/BOX	25	25.000	
G13	24	-	3000	≥ 80	120	A++	230	4000	-	28 x 1500	1/BOX	25	25.000	
G13	24	-	3000	≥ 80	120	A++	230	6500	-	28 x 1500	1/BOX	25	25.000	

**MÜLLER-LICHT unterstützt Sie optimal in Ihren Abverkäufen:  
Mit dem LED-Röhren-Display.**

Weitere Informationen dazu finden Sie auf Seite 89.

**MÜLLER-LICHT vous accompagne et vous aide à mieux vendre:  
Avec des affichages LED.**

Vous trouverez plus d'informations sur ce thème page 89.

**MÜLLER-LICHT gives you optimal support for your sales activities:  
With the LED tube display.**

Further information can be found on page 89.



<sup>1</sup> Messung nicht nach Halbwertswinkeln.

<sup>1</sup> Mesure prise sans les angles moyens.

<sup>1</sup> Measurement not to half-angles.

<sup>2</sup> Alle LED-Röhren inklusive Blindstarter.

<sup>2</sup> Tous les tubes LED starter inclus.

<sup>2</sup> All LED tubes are including blindstarter.



## Ra FARBWIEDERGABEINDEX

Der Farbwiedergabeindex beschreibt die Genauigkeit der Farbwiedergabe und gibt somit Auskunft über die Lichtqualität. Anders gesagt, er gibt an, wie natürlich Farben eines beleuchteten Objektes im Licht der Lampe erscheinen.







## INDICE DE RENDU DE LUMIERE Ra

L'indice de rendu de lumière décrit le niveau d'exactitude du rendu de couleur et donne des informations sur la qualité lumineuse. En d'autres termes, il indique dans quelle mesure les couleurs naturelles d'un objet éclairé apparaissent dans la lumière de la lampe.

## Ra COLOR RENDERING INDEX

The color rendering index describes the precision of the color rendering and thus provides information about the lighting quality. To put it another way, it indicates how natural colors of an illuminated object appear in the light from the lamp.

## HD-LED

				1	400135	Hochvolt-Stiftsockel / Capsule haute tension / Main voltage capsule
				2	400121	Reflektor / Réflecteur / Reflector
				3	400122	Reflektor / Réflecteur / Reflector
				4	400018	Kerze / Flamme / Candle
				5	400036	Miniglobe / Mini globe / Mini Globe
				6	400035	Miniglobe / Mini globe / Mini Globe
				7	400070	Reflektor / Réflecteur / Reflector <b>R50</b>
				8	400123	Reflektor / Réflecteur / Reflector <b>R63</b>
				9	400117	Birne / Forme standard / Bulb
				10	400118	Birne / Forme standard / Bulb
				11	400119	Birne / Forme standard / Bulb
				11	400120	Birne / Forme standard / Bulb

## HD-LED

	1	400126	S14s / S14s / S14s
	2	400127	S14s / S14s / S14s
	3	400132	S14d / S14d / S14d
	4	400133	S14d / S14d / S14d

GAMME HD-LED EN EXCLUSIVITE CHEZ MÜLLER-LICHT

Avec les lampes HD-LED de MÜLLER-LICHT, vos clients profitent d'une technique LED sans précédent, très proche de celle de l'ampoule à incandescence. Nos lampes HD-LED à faible consommation et durables affichant un indice de rendu de lumière Ra ≥ 90 permettent de créer une ambiance lumineuse et un éclairage encore plus naturels grâce à une qualité de lumière supérieure. Grâce à une technique LED plus perfectionnée qui permet une meilleure définition du spectre lumineux, les couleurs sont plus vives et brillantes. A vous de briller également en magasin grâce aux systèmes HD-LED: l'emballage des lampes HD-LED de MÜLLER-LICHT se démarque avec son film argenté de qualité, ce qui devrait faciliter et « booster » les ventes. Grâce à un encart très tape-à-l'œil, le client en apprendra également davantage sur le principe HD.

HD-LED EXCLUSIVELY FROM MÜLLER-LICHT

With the HD-LED lamps from MÜLLER-LICHT, your customers benefit from an LED technology that comes closer to the incandescent bulb than ever before. Our frugal and long-lasting HD-LED lamps with a color rendering index of Ra ≥ 90 provide an even more natural lighting effect with an improved lighting quality. Based on the improved LED technology, which enables the light spectrum to be more finely attuned, colors are rendered more vibrantly and brilliantly. HD-LED also stands out at the POS: The MÜLLER-LICHT HD-LED lamp packaging features an attractive and exclusive silver film and has an especially promoting effect on purchasers. Moreover the customer experiences by a striking banner everything related to the HD-principle.

# HD-LED EXKLUSIV BEI MÜLLER-LICHT

Mit den HD-LED Lampen von MÜLLER-LICHT profitieren Ihre Kunden von einer LED-Technik, die so nah an der Glühlampe ist wie nie zuvor. Unsere sparsamen und langlebigen HD-LED Lampen mit einem Farbwiedergabeindex von Ra ≥ 90 schaffen durch eine verbesserte Lichtqualität eine noch natürlichere Lichtwirkung. Aufgrund einer verbesserten LED-Technik, die eine feinere Abstimmung des Lichtspektrums ermöglicht, werden Farben lebendiger und brillanter wiedergegeben.

Punkten Sie mit HD-LED auch am POS: Die Verpackung der MÜLLER-LICHT HD-LED Lampen besticht durch eine exklusive Silberfolie und ist damit besonders verkaufsfördernd. Darüber hinaus erfährt der Kunde über eine auffällige Regalfahne alles rund um das HD-Prinzip.

**3** Jahre Garantie  
ans garantie  
years warranty  
[www.mueller-licht.de/garantie](http://www.mueller-licht.de/garantie)

G9	3	21	200	≥ 90	270	A+	220-240	2700	-	18 x 50	1/BLI	8	30.000	
GU5.3	5	28	280	≥ 90	38	A	12	2700	-	50 x 47	1/BLI	6	30.000	
GU10	5	42	280	≥ 90	40	A+	220-240	2700	✓	50 x 55	1/BLI	6	30.000	
E14	5,5	40	470	≥ 90	180	A+	220-240	2700	✓	37 x 103	1/BLI	7	30.000	
E14	5,5	40	470	≥ 90	180	A+	220-240	2700	✓	45 x 80	1/BLI	7	30.000	
E27	5,5	40	470	≥ 90	180	A+	220-240	2700	✓	45 x 81	1/BLI	7	30.000	
E14	6	40	420	≥ 90	> 120 <sup>1</sup>	A+	220-240	2700	✓	50 x 86	1/BLI	6	30.000	
E27	8	45	530	≥ 90	> 120 <sup>1</sup>	A+	220-240	2700	✓	63 x 102	1/BLI	5	30.000	
E27	7	40	470	≥ 90	200	A+	220-240	2700	✓	60 x 110	1/BLI	4	30.000	
E27	7	40	470	≥ 90	200	A+	220-240	2700	✓	60 x 110	1/BLI	4	30.000	
E27	11	60	806	≥ 90	200	A+	220-240	2700	✓	60 x 120	1/BLI	4	30.000	
E27	13	75	1055	≥ 90	200	A+	220-240	2700	✓	60 x 120	1/BLI	4	30.000	

S14s	5	28	290	≥ 90	170	A+	220-240	2700	-	30 x 300	1/BOX	6	30.000	
S14s	8	37	420	≥ 90	170	A	220-240	2700	-	30 x 500	1/BOX	6	30.000	
S14d	5	28	290	≥ 90	170	A+	220-240	2700	-	30 x 300	1/BOX	6	30.000	
S14d	8	37	420	≥ 90	170	A	220-240	2700	-	30 x 500	1/BOX	6	30.000	

<sup>1</sup> Messung nicht nach Halbwertswinkeln. / Mesure prise sans les angles moyens. / Measurement not to half-angles.



## Essentials



1	400021 <sup>2</sup>	Kerze / Flamme / Candle
1	400140	Kerze / Flamme / Candle
1	400227 <sup>2,3</sup>	Kerze / Flamme / Candle
2	400037 <sup>2</sup>	Miniglobe / Mini globe / Mini Globe
2	400141	Miniglobe / Mini globe / Mini Globe
3	400229 <sup>3</sup>	Miniglobe / Mini globe / Mini Globe
4	400038	Miniglobe / Mini globe / Mini Globe
4	400151	Miniglobe / Mini globe / Mini Globe
5	400057 <sup>2</sup>	Reflektor / Réflecteur / Reflector
5	400158	Reflektor / Réflecteur / Reflector
5	400231 <sup>2,3</sup>	Reflektor / Réflecteur / Reflector
5	400232 <sup>3</sup>	Reflektor / Réflecteur / Reflector
6	400064	Reflektor / Réflecteur / Reflector
6	400234 <sup>2,3</sup>	Reflektor / Réflecteur / Reflector
7	400071 <sup>2</sup>	Reflektor / Réflecteur / Reflector <b>R50</b>
8	400006 <sup>2</sup>	Birne / Forme standard / Bulb
8	400150	Birne / Forme standard / Bulb
8	400016 <sup>2</sup>	Birne / Forme standard / Bulb
8	400139	Birne / Forme standard / Bulb

<sup>2</sup>Auch als Displaytray verfügbar. Weitere Informationen finden Sie auf Seite 88.

Disponible également sous la forme de plateau publicitaire. Vous trouverez plus d'informations page 88.

Also available on display tray. Additional information see on page 88.

**DES PRIX DE DEPART TRES ABORDABLES**

La gamme MÜLLER-LICHT Essential comprend des lampes LED de qualité à des prix de départ très abordables. Ces produits conviennent parfaitement bien aux actions commerciales, sans oublier leur emballage qui joue un rôle déterminant pour cette catégorie de prix.

En plus des emballages contenant un seul produit, de nombreuses références sont proposées par deux. Les cartons publicitaires sont également empilables. A vous de concevoir et d'organiser vos rayons en fonction de vos besoins. Vous trouverez plus d'informations page 88.

**PRICE-ENTRY ASSORTMENT**

The MÜLLER-LICHT Essential assortment includes high-quality LED lamps at affordable entry-level prices. These items are particularly suitable for promotions, especially as they are different in their packaging, which optimally supports the entry-level price.

Besides availability in single box, many items are also available as 2pcs.-box. Moreover the display boxes are stackable. Arrange your display individually according to your own requirements. Further information can be found on page 88.

# GÜNSTIGE EINSTIEGSPREISE

Das MÜLLER-LICHT Essential Sortiment umfasst qualitativ hochwertige LED-Lampen zu günstigen Einstiegspreisen. Diese Artikel eignen sich besonders gut für Werbeaktionen, zumal sie sich auch in ihrer Verpackung, die den Preiseinstieg optimal unterstützt, unterscheiden.

Neben der Verfügbarkeit als Einzelbox sind viele Artikel auch als 2er-Boxen erhältlich. Darüber hinaus sind die Displaykartons stapelbar.

Stellen Sie sich Ihr Display individuell nach Ihren Ansprüchen zusammen.

Weitere Informationen dazu finden

Sie auf Seite 88.



	Icon	W	Icon	lm	Ra	Icon	Icon	V	K	Icon	Icon	Box/ Blister	Icon	Icon
	E14	3	25	250	≥ 80	180	A+	220-240	2700	-	37 x 100	1/BOX	10	10.000
	E14	3	25	250	≥ 80	180	A+	220-240	2700	-	37 x 100	2/BOX	5	10.000
	E14	5,5	40	470	≥ 80	180	A+	220-240	2700	-	37 x 100	1/BOX	10	10.000
	E14	3	25	250	≥ 80	180	A+	220-240	2700	-	45 x 81	1/BOX	10	10.000
	E14	3	25	250	≥ 80	180	A+	220-240	2700	-	45 x 81	2/BOX	5	10.000
	E14	5,5	40	470	≥ 80	180	A+	220-240	2700	-	45 x 81	1/BOX	10	10.000
	E27	3	25	250	≥ 80	180	A+	220-240	2700	-	45 x 81	1/BOX	10	10.000
	E27	3	25	250	≥ 80	180	A+	220-240	2700	-	45 x 81	2/BOX	5	10.000
	GU10	3	-	230	≥ 80	> 120 <sup>1</sup>	A+	220-240	2700	-	50 x 55	1/BOX	8	10.000
	GU10	3	-	230	≥ 80	> 120 <sup>1</sup>	A+	220-240	2700	-	50 x 55	2/BOX	5	10.000
	GU10	5	> 50	320	≥ 80	> 120 <sup>1</sup>	A+	220-240	2700	-	50 x 55	1/BOX	8	10.000
	GU10	5	> 50	320	≥ 80	> 120 <sup>1</sup>	A+	220-240	2700	-	50 x 55	2/BOX	5	10.000
	GU5.3	3	-	230	≥ 80	> 120 <sup>1</sup>	A+	12	2700	-	50 x 50	1/BOX	10	10.000
	GU5.3	5	> 50	320	≥ 80	> 120 <sup>1</sup>	A+	12	2700	-	45 x 50	1/BOX	10	10.000
	E14	6	40	430	≥ 80	> 120 <sup>1</sup>	A+	220-240	2700	-	50 x 86	1/BOX	6	10.000
	E27	5,5	40	470	≥ 80	200	A+	220-240	2700	-	60 x 109	1/BOX	10	10.000
	E27	5,5	40	470	≥ 80	200	A+	220-240	2700	-	60 x 109	2/BOX	5	10.000
	E27	10	60	810	≥ 80	200	A+	220-240	2700	-	60 x 109	1/BOX	10	10.000
	E27	10	60	810	≥ 80	200	A+	220-240	2700	-	60 x 109	2/BOX	5	10.000

<sup>1</sup> Messung nicht nach Halbwertswinkeln.

<sup>1</sup> Mesure prise sans les angles moyens.

<sup>1</sup> Measurement not to half-angles.







<sup>3</sup> Verfügbar ab Quartal 2.

<sup>3</sup> Commercialisé à partir du 2<sup>ème</sup> trimestre



<sup>3</sup> Available from quarter 2.



## Retro-LED Birnen / Ampoule forme standard LED rétro / Retro-LED Bulbs

			1 400013 Birne / Forme standard / Bulb
			1 400218 <sup>2</sup> Birne / Forme standard / Bulb
1	2	3	1 400146 Birne / Forme standard / Bulb
4	5	6	1 400001 Birne / Forme standard / Bulb
			1 400176 <sup>2</sup> Birne / Forme standard / Bulb
			1 400177 <sup>3</sup> Birne / Forme standard / Bulb
			2 400180 <sup>2</sup> Birne / Forme standard / Bulb
			2 400181 <sup>3</sup> Birne / Forme standard / Bulb
			3 400000 Birne, matt / Forme standard, mat / Bulb, frosted
			3 400002 Birne, matt / Forme standard, mat / Bulb, frosted
			3 400178 <sup>2</sup> Birne, matt / Forme standard, mat / Bulb, frosted
			3 400179 <sup>3</sup> Birne, matt / Forme standard, mat / Bulb, frosted
			4 400182 <sup>2</sup> Birne, matt / Forme standard, mat / Bulb, frosted
			4 400183 <sup>3</sup> Birne, matt / Forme standard, mat / Bulb, frosted
			5 400175 <sup>2</sup> Birne gold / Forme standard, doré / Bulb, gold
			6 400214 <sup>3</sup> Birne, verspiegelt / Forme standard, argenté / Bulb, mirrored

## Retro-LED Reflektoren / Réflecteurs LED rétro / Reflectors

			1 400055 Reflektor / Réflecteur / Reflector
1	2	3	1 400149 Reflektor / Réflecteur / Reflector
			2 400160 Reflektor / Réflecteur / Reflector
			3 400062 Reflektor / Réflecteur / Reflector

<sup>2</sup> Verfügbar ab Quartal 2. / Commercialisé à partir du 2<sup>ème</sup> trimestre. / Available from quarter 2.

<sup>3</sup> Verfügbar ab Quartal 3. / Commercialisé à partir du 3<sup>ème</sup> trimestre. / Available from quarter 3.

LE RETOUR D'UNE SOLUTION COMPARABLE  
A L'AMPOULE A INCANDESCENCE

Profitez également de notre gamme LED rétro déjà bien établie sur le marché allemand et célébrez, chez votre client, grâce aux nouveaux produits LED rétro, le retour de la célèbre ampoule à incandescence. Les dimensions des lampes LED sont identiques à celles des ampoules classiques. Nos LED rétro se caractérisent par leur lumière étincelante et leur niveau d'efficacité énergétique élevé. Le boîtier en verre attire également tous les regards car il permet d'utiliser les lampes dans des luminaires assez ouverts, comme les lustres. La couleur lumineuse chaude crée une ambiance conviviale qui invite à la détente.

THE LIGHT BULB THAT LOOKS  
LIKE AN ORDINARY BULB

Take advantage of the well-largest retro LED assortment in the German market and bring the conventional light bulb back to your customers' homes with the retro LED products. The dimensions of the LED lamps are identical to those of the conventional incandescent bulb. Our retro LEDs are characterized by all around shining light and high energy efficiency. The glass housing is also an eye-catcher, which makes it especially well-suited for lamps with exposed lighting, such as chandeliers. The warm color of the lamp generates a pleasant atmosphere that invites you to relax.

# DER „GLÜHBIRNE“ ZUM VERWECHSELN ÄHNLICH

Profitieren Sie vom wohl größten Retro-LED Sortiment am deutschen Markt und bringen Sie mit den Retro-LED Produkten die herkömmliche Glühlampe zurück in das Zuhause Ihrer Kunden. Die Abmessungen der LED-Lampen sind im Vergleich zur herkömmlichen Glühlampe identisch. Ein rundum strahlendes Licht, sowie hohe Energieeffizienz zeichnen unsere Retro-LEDs aus. Zudem ist das Glasgehäuse ein optischer Hingucker, der es ermöglicht, die Lampen besonders in offenen Leuchten, wie z.B. Kronleuchtern, zu verwenden. Die warmweiße Lichtfarbe erzeugt dabei eine wohnliche Atmosphäre, die zum Entspannen einlädt.



**3** Jahre Garantie  
ans garantie  
years warranty  
[www.mueller-licht.de/garantie](http://www.mueller-licht.de/garantie)

Icon	W	Icon	lm	Ra	Icon	Icon	V	K	Icon	Icon	Box/Blister	Icon	Icon
E27	4	40	470	≥ 80	360 <sup>1</sup>	A++	220-240	2700	-	60 x 105	1/BLI	4	15.000
E27	4	40	470	≥ 80	360 <sup>1</sup>	A++	220-240	2700	-	60 x 105	1/BOX	10	15.000
E27	4	40	470	≥ 80	360 <sup>1</sup>	A++	220-240	2700	-	60 x 105	2/BOX	10	15.000
E27	6	51	650	≥ 80	360 <sup>1</sup>	A++	220-240	2700	-	60 x 106	1/BLI	4	15.000
E27	6	60	810	≥ 80	360 <sup>1</sup>	A++	220-240	2700	-	60 x 105	1/BLI	4	15.000
E27	6	60	810	≥ 80	360 <sup>1</sup>	A++	220-240	2700	✓	60 x 105	1/BLI	4	15.000
E27	8	75	1055	≥ 80	360 <sup>1</sup>	A++	220-240	2700	-	67 x 118	1/BLI	4	15.000
E27	8	75	1055	≥ 80	360 <sup>1</sup>	A++	220-240	2700	✓	67 x 118	1/BLI	4	15.000
E27	4	40	470	≥ 80	360 <sup>1</sup>	A++	220-240	2700	-	60 x 105	1/BLI	4	15.000
E27	6	51	650	≥ 80	360 <sup>1</sup>	A++	220-240	2700	-	60 x 106	1/BLI	4	15.000
E27	6	60	810	≥ 80	360 <sup>1</sup>	A++	220-240	2700	-	60 x 105	1/BLI	4	15.000
E27	6	60	810	≥ 80	360 <sup>1</sup>	A++	220-240	2700	✓	60 x 105	1/BLI	4	15.000
E27	8	75	1055	≥ 80	360 <sup>1</sup>	A++	220-240	2700	-	67 x 118	1/BLI	4	15.000
E27	8	75	1055	≥ 80	360 <sup>1</sup>	A++	220-240	2700	✓	67 x 118	1/BLI	4	15.000
E27	4	36	400	≥ 80	360 <sup>1</sup>	A++	220-240	2000	-	60 x 105	1/BLI	4	15.000
E27	6	54	690	≥ 80	360 <sup>1</sup>	A++	220-240	2700	✓	60 x 105	1/BLI	4	15.000

Icon	W	Icon	lm	Ra	Icon	Icon	V	K	Icon	Icon	Box/Blister	Icon	Icon
GU10	5	45	300	≥ 80	30	A+	220-240	2700	-	51 x 53	1/BLI	6	25.000
GU10	5	45	300	≥ 80	30	A+	220-240	2700	-	51 x 53	2/BOX	10	25.000
GU10	7	> 50	460	≥ 80	40	A+	220-240	2700	✓	50 x 54	1/BLI	6	25.000
GU5.3	5	31	300	≥ 80	30	A+	12	2700	-	50 x 45	1/BLI	6	25.000

<sup>1</sup> Messung nicht nach Halbwertswinkeln. / Mesure prise sans les angles moyens. / Measurement not to half-angles.





## Retro-LED Globes / Globes LED rétro / Retro-LED Globes

						1	400030	Miniglobe / Mini globe / Mini Globe
1	2	3	4	5	6	1	400147	Miniglobe / Mini globe / Mini Globe
						2	400197 <sup>2</sup>	Miniglobe / Mini globe / Mini Globe
7	8	9				3	400029	Miniglobe / Mini globe / Mini Globe
						4	400223 <sup>2</sup>	Miniglobe / Mini globe / Mini Globe
10	11	12				5	400031	Miniglobe, matt / Mini globe, mat / Mini Globe, frosted
						6	400199 <sup>2</sup>	Miniglobe, matt / Mini globe, mat / Mini Globe, frosted
						7	400196 <sup>2</sup>	Miniglobe, gold / Mini globe, doré / Mini Globe, gold
						8	400047	Globe, matt / Globe, mat / Globe, frosted
						9	400048	Globe / Globe / Globe
						10	400202 <sup>3</sup>	Globe / Globe / Globe
						11	400204 <sup>3</sup>	Globe, gold / Globe, doré / Globe, gold
						12	400216 <sup>3</sup>	Globe, verspiegelt / Globe, argenté / Globe, mirrored

## Retro-LED Kerzen / Ampoules flamme LED rétro / Retro-LED Candles

						1	400184 <sup>2</sup>	Kerze / Flamme / Candle
1	2	3	4	5	6	1	400019	Kerze / Flamme / Candle
						1	400217 <sup>2</sup>	Kerze / Flamme / Candle
						1	400148	Kerze / Flamme / Candle
						2	400190 <sup>2</sup>	Kerze / Flamme / Candle
						3	400185 <sup>2</sup>	Kerze, matt / Flamme, mat / Candle, frosted
						3	400025	Kerze, matt / Flamme, mat / Candle, frosted
						3	400192 <sup>2</sup>	Kerze, matt / Flamme, mat / Candle, frosted
						4	400189 <sup>2</sup>	Kerze, gedreht / Flamme, torsadée / Candle, twisted
						5	400188 <sup>2</sup>	Kerze, gold / Flamme, doré / Candle, gold
						6	400024	Kerze, windstoß / Flamme, coup de vent / Candle, cosy light

## Retro-LED Sonderformen / Forme spécifique LED retró / Retro-LED special shapes

					1	400027	Tube / Tube / Tube <b>T25</b>
1	2	3	4	5	2	400206 <sup>3</sup>	ST64 / ST64 / ST64
					3	400208 <sup>3</sup>	ST64, gold / ST64, doré / ST64, gold
					4	400210 <sup>3</sup>	BTT / BTT / BTT
					5	400212 <sup>3</sup>	BTT, gold / BTT, doré / BTT, gold

<sup>2</sup> Verfügbar ab Quartal 2. / Commercialisé à partir du 2<sup>ème</sup> trimestre. / Available from quarter 2.

<sup>3</sup> Verfügbar ab Quartal 3. / Commercialisé à partir du 3<sup>ème</sup> trimestre. / Available from quarter 3.

		W		lm	Ra			V	K			Box/ Blister		
E14	2	25	250	≥ 80	360 <sup>1</sup>	A++	220-240	2700	-	-	45 x 84	1/BLI	7	15.000
E14	2	25	250	≥ 80	360 <sup>1</sup>	A++	220-240	2700	-	-	45 x 84	2/BOX	10	15.000
E14	4	40	470	≥ 80	360 <sup>1</sup>	A++	220-240	2700	-	-	45 x 84	1/BLI	7	15.000
E27	2	25	250	≥ 80	360 <sup>1</sup>	A++	220-240	2700	-	-	45 x 84	1/BLI	7	15.000
E27	4	40	470	≥ 80	360 <sup>1</sup>	A++	220-240	2700	-	-	45 x 84	1/BLI	7	15.000
E14	2	25	250	≥ 80	360 <sup>1</sup>	A++	220-240	2700	-	-	45 x 84	1/BLI	7	15.000
E14	4	40	470	≥ 80	360 <sup>1</sup>	A++	220-240	2700	-	-	45 x 84	1/BLI	7	15.000
E14	2	17	150	≥ 80	360 <sup>1</sup>	A++	220-240	2000	-	-	45 x 84	1/BLI	7	15.000
E27	4	40	470	≥ 80	360 <sup>1</sup>	A++	220-240	2700	-	-	95 x 140	1/BLI	3	15.000
E27	4	40	470	≥ 80	360 <sup>1</sup>	A++	220-240	2700	-	-	95 x 140	1/BLI	3	15.000
E27	8	75	1055	≥ 80	360 <sup>1</sup>	A++	220-240	2700	✓	-	95 x 135	1/BLI	3	15.000
E27	8	66	900	≥ 80	360 <sup>1</sup>	A++	220-240	2000	✓	-	95 x 135	1/BLI	3	15.000
E27	8	66	890	≥ 80	360 <sup>1</sup>	A++	220-240	2700	✓	-	95 x 135	1/BLI	3	15.000

		W		lm	Ra			V	K			Box/ Blister		
E14	1,5	15	150	≥ 80	360 <sup>1</sup>	A++	220-240	2700	-	-	35 x 98	1/BLI	7	15.000
E14	2	25	250	≥ 80	360 <sup>1</sup>	A++	220-240	2700	-	-	35 x 99	1/BLI	7	15.000
E14	2	25	250	≥ 80	360 <sup>1</sup>	A++	220-240	2700	-	-	35 x 99	1/BOX	10	15.000
E14	2	25	250	≥ 80	360 <sup>1</sup>	A++	220-240	2700	-	-	35 x 99	2/BOX	10	15.000
E14	4	40	470	≥ 80	360 <sup>1</sup>	A++	220-240	2700	-	-	35 x 99	1/BLI	7	15.000
E14	1,5	15	150	≥ 80	360 <sup>1</sup>	A++	220-240	2700	-	-	35 x 99	1/BLI	7	15.000
E14	2	25	250	≥ 80	360 <sup>1</sup>	A++	220-240	2700	-	-	35 x 99	1/BLI	7	15.000
E14	4	40	470	≥ 80	360 <sup>1</sup>	A++	220-240	2700	-	-	35 x 99	1/BLI	7	15.000
E14	2	25	250	≥ 80	360 <sup>1</sup>	A++	220-240	2700	-	-	35 x 99	1/BLI	7	15.000
E14	2	17	150	≥ 80	360 <sup>1</sup>	A++	220-240	2000	-	-	35 x 99	1/BLI	7	15.000
E14	2	25	250	≥ 80	360 <sup>1</sup>	A++	220-240	2700	-	-	35 x 120	1/BLI	7	15.000

		W		lm	Ra			V	K			Box/ Blister		
E14	2	25	250	≥ 80	360 <sup>1</sup>	A++	220-240	2700	-	-	25 x 85	1/BLI	7	15.000
E27	6	60	810	≥ 80	360 <sup>1</sup>	A++	220-240	2700	✓	-	64 x 143	1/BLI	3	15.000
E27	6	54	690	≥ 80	360 <sup>1</sup>	A++	220-240	2000	✓	-	64 x 143	1/BLI	3	15.000
E27	6	60	810	≥ 80	360 <sup>1</sup>	A++	220-240	2700	✓	-	46 x 105	1/BLI	4	15.000
E27	6	54	690	≥ 80	360 <sup>1</sup>	A++	220-240	2000	✓	-	46 x 105	1/BLI	4	15.000

<sup>1</sup> Messung nicht nach Halbwerts winkeln. / Mesure prise sans les angles moyens. / Measurement not to half-angles.





## HÖCHSTE LICHTQUALITÄT

Neben der herkömmlichen Glühlampe gehören Halogenlampen seit Jahrzehnten zur Standardbeleuchtung in Haushalten. Durch ihr warmweißes Licht, eine längere Lebensdauer, eine sehr gute Farbwiedergabe sowie eine vollständige Dimmbarkeit eignen sich Halogenlampen als Alternative zu herkömmlichen Glühlampen. Die große Produktvielfalt von MÜLLER-LICHT bietet nahezu unbegrenzte Anwendungsmöglichkeiten im Wohn- und Außenbereich.

### UN NIVEAU OPTIMAL DE QUALITE LUMINEUSE

En plus des ampoules classiques, les lampes halogène font partie, depuis des décennies, des éclairages classiques des foyers. Avec leur lumière blanche chaleureuse, leur longue durée de vie, un rendu de la lumière très satisfaisant et leur régulation totale, les lampes halogènes font office d'alternatives intéressantes aux ampoules classiques. La grande diversité de produits MÜLLER-LICHT offre des possibilités d'utilisation quasiment illimitées à l'intérieur comme à l'extérieur.

### HIGHEST LIGHT QUALITY

In addition to conventional incandescent bulbs, halogen lamps have been a part of standard household lighting for decades. With their warm white light, a longer service life, very good color rendering and a full dimming range, halogen lamps are an excellent alternative to conventional incandescent bulbs. The large range of products of MÜLLER-LICHT offers nearly unlimited applications for indoors and outdoor.

## Birne / Forme standard / Bulb



1	300001	Birne / Forme standard / Bulb
1	300002	Birne / Forme standard / Bulb
1	300064	Birne / Forme standard / Bulb
1	300003	Birne / Forme standard / Bulb
1	300065	Birne / Forme standard / Bulb
1	300004	Birne / Forme standard / Bulb
1	300005	Birne / Forme standard / Bulb

## Globe / Globe / Globe

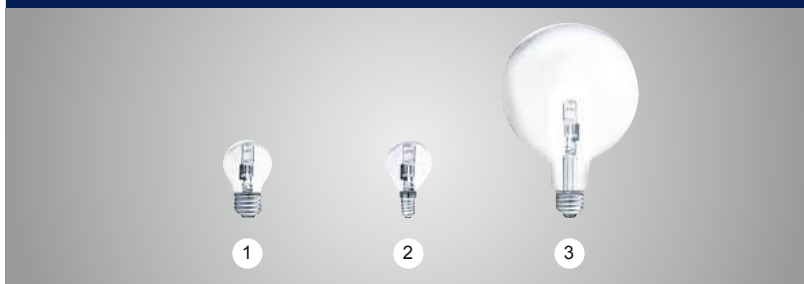

1	300006	Miniglobe / Mini globe / Mini Globe
1	300007	Miniglobe / Mini globe / Mini Globe
2	300008	Miniglobe / Mini globe / Mini Globe
2	300009	Miniglobe / Mini globe / Mini Globe
3	300000	Globe / Globe / Globe

## Kerze und Reflektor / Flamme et Réflecteur / Candle and reflector



1	300010	Kerze / Flamme / Candle
1	300066	Kerze / Flamme / Candle
1	300011	Kerze / Flamme / Candle
1	300067	Kerze / Flamme / Candle
2	300012	Kerze, gedreht / Flamme, torsadée / Candle, twisted
2	300013	Kerze, gedreht / Flamme, torsadée / Candle, twisted
3	300014	Kerze, windstoß / Flamme, coup de vent / Candle, cosy light
3	300015	Kerze, windstoß / Flamme, coup de vent / Candle, cosy light
4	300016 <sup>2</sup>	Reflektor / Réflecteur / Reflector <b>R50</b>
4	300017	Reflektor / Réflecteur / Reflector <b>R50</b>
4	300068	Reflektor / Réflecteur / Reflector <b>R50</b>
5	300018 <sup>2</sup>	Reflektor / Réflecteur / Reflector
5	300019 <sup>2</sup>	Reflektor / Réflecteur / Reflector

## Reflektor / Réflecteur / Reflector



1	300053 <sup>2</sup>	Reflektor / Réflecteur / Reflector
1	300020 <sup>2</sup>	Reflektor / Réflecteur / Reflector
1	300054 <sup>2</sup>	Reflektor / Réflecteur / Reflector
1	300022 <sup>2</sup>	Reflektor / Réflecteur / Reflector
1	300055 <sup>2</sup>	Reflektor / Réflecteur / Reflector
1	300024 <sup>2</sup>	Reflektor / Réflecteur / Reflector
2	300025 <sup>2</sup>	Reflektor, satin / Réflecteur, satin / Reflector, satin
3	300026	Reflektor / Réflecteur / Reflector <b>MR11</b>
3	300028	Reflektor / Réflecteur / Reflector <b>MR11</b>
4	300027	Reflektor / Réflecteur / Reflector <b>MR16</b>
4	300029	Reflektor / Réflecteur / Reflector <b>MR16</b>
4	300030	Reflektor / Réflecteur / Reflector <b>MR16</b>
4	300031	Reflektor / Réflecteur / Reflector <b>MR16</b>

<sup>2</sup> Gemäß ErP-Richtlinie Nr. EU/1194/2012 laufen diese Produkte zum 01.09.2016 aus. Weitere Informationen dazu finden Sie auf Seite 24.

<sup>2</sup> Conformément à la Directive ErP n°EU/1194/2012, ces produits ne seront plus proposés à compter du 01/09/2016. Vous trouverez plus d'informations page 24.

<sup>2</sup> These products will be phased out by 9/1/2016 in accordance with ErP Directive No. EU/1194/2012. Further information can be found on page 24.

	<b>W</b>		<b>lm</b>	<b>Ra</b>			<b>V</b>	<b>K</b>					
E27	20	25	235	≥ 100	360 <sup>1</sup>	D	230	2900	✓	55 x 100	1/BOX	10	2.000
E27	30	37	405	≥ 100	360 <sup>1</sup>	D	230	2900	✓	55 x 100	1/BOX	10	2.000
E27	30	37	405	≥ 100	360 <sup>1</sup>	D	230	2900	✓	55 x 100	2/BOX	5	2.000
E27	46	56	700	≥ 100	360 <sup>1</sup>	D	230	2900	✓	55 x 100	1/BOX	10	2.000
E27	46	56	700	≥ 100	360 <sup>1</sup>	D	230	2900	✓	55 x 100	2/BOX	5	2.000
E27	57	70	915	≥ 100	360 <sup>1</sup>	D	230	2900	✓	55 x 100	1/BOX	10	2.000
E27	77	93	1320	≥ 100	360 <sup>1</sup>	D	230	2900	✓	55 x 100	1/BOX	10	2.000

	<b>W</b>		<b>lm</b>	<b>Ra</b>			<b>V</b>	<b>K</b>					
E27	20	25	235	≥ 100	360 <sup>1</sup>	D	230	2900	✓	45 x 75	1/BOX	10	2.000
E27	30	37	405	≥ 100	360 <sup>1</sup>	D	230	2900	✓	45 x 75	1/BOX	10	2.000
E14	20	25	235	≥ 100	360 <sup>1</sup>	D	230	2900	✓	45 x 78	1/BOX	10	2.000
E14	30	37	405	≥ 100	360 <sup>1</sup>	D	230	2900	✓	45 x 78	1/BOX	10	2.000
E27	46	56	700	≥ 100	360 <sup>1</sup>	D	230	2900	✓	125 x 176	1/BOX	6	2.000

	<b>W</b>		<b>lm</b>	<b>Ra</b>			<b>V</b>	<b>K</b>					
E14	20	25	235	≥ 100	360 <sup>1</sup>	D	230	2900	✓	35 x 100	1/BOX	10	2.000
E14	20	25	235	≥ 100	360 <sup>1</sup>	D	230	2900	✓	35 x 100	2/BOX	5	2.000
E14	30	37	405	≥ 100	360 <sup>1</sup>	D	230	2900	✓	35 x 100	1/BOX	10	2.000
E14	30	37	405	≥ 100	360 <sup>1</sup>	D	230	2900	✓	35 x 100	2/BOX	5	2.000
E14	20	25	235	≥ 100	360 <sup>1</sup>	D	230	2900	✓	35 x 100	1/BOX	10	2.000
E14	30	37	405	≥ 100	360 <sup>1</sup>	D	230	2900	✓	35 x 100	1/BOX	10	2.000
E14	20	25	235	≥ 100	360 <sup>1</sup>	D	230	2900	✓	35 x 122	1/BOX	10	2.000
E14	30	37	405	≥ 100	360 <sup>1</sup>	D	230	2900	✓	35 x 122	1/BOX	10	2.000
E14	20	-	100	≥ 100	20	D	230	2900	✓	50 x 85	1/BOX	10	2.000
E14	30	-	180	≥ 100	20	D	230	2900	✓	50 x 86	1/BOX	10	2.000
E14	30	-	180	≥ 100	20	D	230	2900	✓	50 x 86	1/BOX	5	2.000
E27	30	-	180	≥ 100	20	D	230	2900	✓	63 x 105	1/BOX	10	2.000
E27	46	-	300	≥ 100	20	D	230	2900	✓	63 x 105	1/BOX	10	2.000

	<b>W</b>		<b>lm</b>	<b>Ra</b>			<b>V</b>	<b>K</b>					
GU10	25	-	120	≥ 100	30	D	230	2900	✓	51 x 55	1/BOX	10	2.000
GU10	25	-	120	≥ 100	30	D	230	2900	✓	51 x 55	2/BLI	6	2.000
GU10	35	-	250	≥ 100	30	D	230	2900	✓	51 x 55	1/BOX	10	2.000
GU10	35	-	250	≥ 100	30	D	230	2900	✓	51 x 55	2/BLI	6	2.000
GU10	50	-	350	≥ 100	30	D	230	2900	✓	51 x 55	1/BOX	10	2.000
GU10	50	-	350	≥ 100	30	D	230	2900	✓	51 x 55	2/BLI	6	2.000
GU10	50	-	400	≥ 100	30	D	230	2900	✓	51 x 55	2/BLI	6	2.000
GU4	10	-	75	≥ 100	30	C	12	2900	✓	35 x 35	1/BLI	7	2.000
GU4	20	-	200	≥ 100	30	C	12	2900	✓	35 x 35	1/BLI	7	2.000
GU5.3	10	-	75	≥ 100	36	C	12	2900	✓	51 x 45	1/BLI	6	2.000
GU5.3	20	-	200	≥ 100	36	C	12	2900	✓	51 x 45	1/BLI	6	2.000
GU5.3	35	-	430	≥ 100	36	C	12	2900	✓	51 x 45	1/BLI	6	2.000
GU5.3	50	-	680	≥ 100	36	C	12	2900	✓	51 x 45	1/BLI	6	2.000

<sup>1</sup> Messung nicht nach Halbwertswinkeln. / Mesure prise sans les angles moyens. / Measurement not to half-angles.

## Stiftsockel / Capsule à broche / Capsule

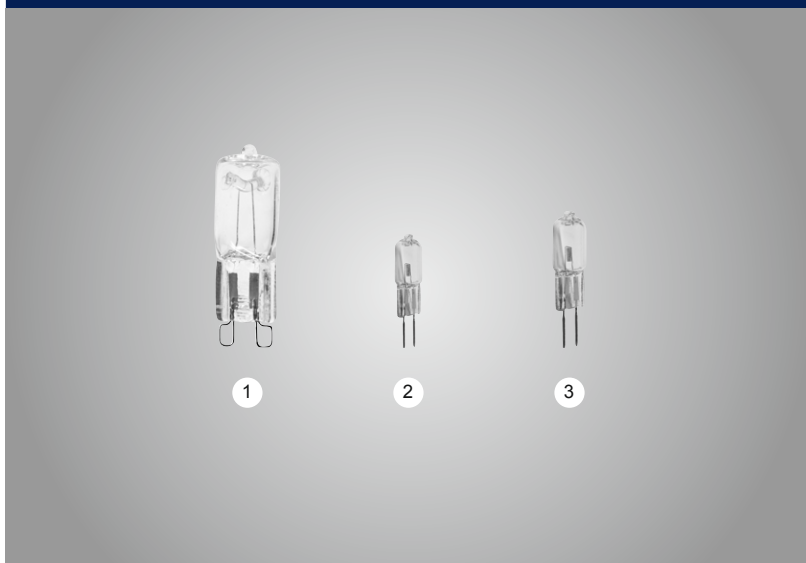

1	300056	Hochvolt-Stiftsockel / Capsule haute tension / Main voltage capsule
1	300032	Hochvolt-Stiftsockel / Capsule haute tension / Main voltage capsule
1	300057	Hochvolt-Stiftsockel / Capsule haute tension / Main voltage capsule
1	300033	Hochvolt-Stiftsockel / Capsule haute tension / Main voltage capsule
1	300058	Hochvolt-Stiftsockel / Capsule haute tension / Main voltage capsule
1	300034	Hochvolt-Stiftsockel / Capsule haute tension / Main voltage capsule
2	300035	Niedervolt-Stiftsockel / Capsule basse tension / Low voltage capsule
2	300036	Niedervolt-Stiftsockel / Capsule basse tension / Low voltage capsule
2	300037	Niedervolt-Stiftsockel / Capsule basse tension / Low voltage capsule
2	300038	Niedervolt-Stiftsockel / Capsule basse tension / Low voltage capsule
3	300039	Niedervolt-Stiftsockel / Capsule basse tension / Low voltage capsule
3	300040	Niedervolt-Stiftsockel / Capsule basse tension / Low voltage capsule
3	300041	Niedervolt-Stiftsockel / Capsule basse tension / Low voltage capsule
3	300042	Niedervolt-Stiftsockel / Capsule basse tension / Low voltage capsule

## Halogenstab / Ampoule Eco-Halogène crayon / Halogen tube

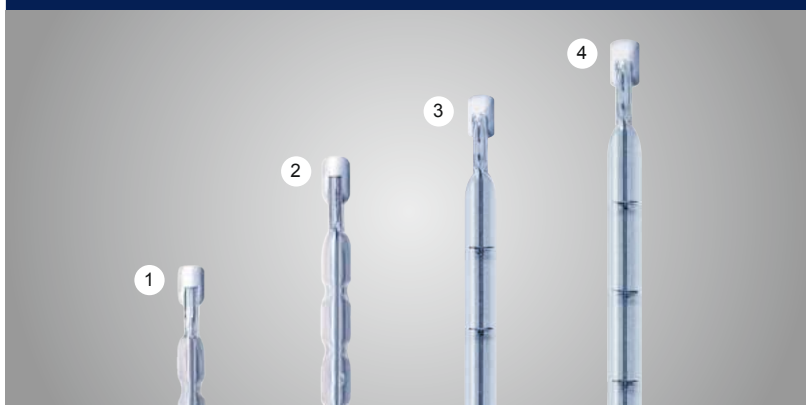

1	300043	Halogenstab / Ampoule Eco-Halogène crayon / Halogen tube
1	300045	Halogenstab / Ampoule Eco-Halogène crayon / Halogen tube
1	300047	Halogenstab / Ampoule Eco-Halogène crayon / Halogen tube
2	300044	Halogenstab / Ampoule Eco-Halogène crayon / Halogen tube
2	300046	Halogenstab / Ampoule Eco-Halogène crayon / Halogen tube
2	300048	Halogenstab / Ampoule Eco-Halogène crayon / Halogen tube
2	300049	Halogenstab / Ampoule Eco-Halogène crayon / Halogen tube
2	300050	Halogenstab / Ampoule Eco-Halogène crayon / Halogen tube
3	300051	Halogenstab / Ampoule Eco-Halogène crayon / Halogen tube
4	300052	Halogenstab / Ampoule Eco-Halogène crayon / Halogen tube

### ErP-Richtlinie









Gemäß ErP-Richtlinie Nr. EU/1194/2012 ist ab 01.09.2016 für alle Netzspannungsglühlampen mit gebündeltem Licht ein EEL von 0,95 gefordert. Somit dürfen Netzspannungsglühlampen z.B. auf Basis GU10, R39/50/63/80 usw., JDR, PAR ab 01.09.2016 nicht mehr in Verkehr gebracht werden. Der Verkauf bereits in Verkehr gebrachter Ware ist weiterhin unbefristet erlaubt.









### Directive ErP

Conformément à la Directive ErP n°EU/1194/2012, toutes les ampoules émettant de la lumière en faisceau doivent, à compter du 01/09/2016, présenter un EEL de 0,95. Ainsi, les modèles d'ampoules basées notamment sur les principes GU10, R39/50/63/80 etc., JDR, PAR ne pourront plus être commercialisés à partir du 01/09/2016. La vente des produits déjà mis sur le marché reste toutefois illimitée dans le temps.

### ErP Directive

In accordance with ErP Directive No. EU/1194/2012, an EEL of 0.95 is required for all mains-supplied light bulbs with focused light, taking effect on 9/1/2016. Therefore, light bulbs supplied with mains voltage, eg. based on GU10, R39/50/63/80, etc. JDR, PAR may no longer be sold after 9/1/2016. There is no limitation on the sale of goods already introduced to the market.







		<b>W</b>		<b>lm</b>	<b>Ra</b>			<b>V</b>	<b>K</b>					
G9		20	-	235	≥ 100	360 <sup>1</sup>	D	230	2900	✓	14 x 45	1/BOX	20	2.000
G9		20	-	235	≥ 100	360 <sup>1</sup>	D	230	2900	✓	14 x 45	1/BLI	8	2.000
G9		33	-	460	≥ 100	360 <sup>1</sup>	D	230	2900	✓	14 x 45	1/BOX	20	2.000
G9		33	-	460	≥ 100	360 <sup>1</sup>	D	230	2900	✓	14 x 45	1/BLI	8	2.000
G9		48	-	740	≥ 100	360 <sup>1</sup>	D	230	2900	✓	14 x 45	1/BOX	20	2.000
G9		48	-	740	≥ 100	360 <sup>1</sup>	D	230	2900	✓	14 x 45	1/BLI	8	2.000
G4		10	-	120	≥ 100	360 <sup>1</sup>	C	12	2900	✓	9 x 30	1/BLI	12	3.000
G4		10	-	120	≥ 100	360 <sup>1</sup>	C	12	2900	✓	9 x 30	3/BLI	12	3.000
G4		20	-	300	≥ 100	360 <sup>1</sup>	C	12	2900	✓	9 x 30	1/BLI	12	3.000
G4		20	-	300	≥ 100	360 <sup>1</sup>	C	12	2900	✓	9 x 30	3/BLI	12	3.000
GY6.35		35	-	520	≥ 100	360 <sup>1</sup>	C	12	2900	✓	11 x 40	1/BLI	12	3.000
GY6.35		35	-	520	≥ 100	360 <sup>1</sup>	C	12	2900	✓	11 x 40	3/BLI	12	3.000
GY6.35		50	-	850	≥ 100	360 <sup>1</sup>	C	12	2900	✓	11 x 40	1/BLI	12	3.000
GY6.35		50	-	850	≥ 100	360 <sup>1</sup>	C	12	2900	✓	11 x 40	3/BLI	12	3.000

		<b>W</b>		<b>lm</b>	<b>Ra</b>			<b>V</b>	<b>K</b>					
R7s		80	-	1380	≥ 100	360 <sup>1</sup>	D	230	2900	✓	78,3	1/BLI	20	2.000
R7s		100	-	1800	≥ 100	360 <sup>1</sup>	D	230	2900	✓	78,3	1/BLI	20	2.000
R7s		120	-	2250	≥ 100	360 <sup>1</sup>	D	230	2900	✓	78,3	1/BLI	20	2.000
R7s		80	-	1450	≥ 100	360 <sup>1</sup>	D	240	2900	✓	117,6	1/BLI	20	2.000
R7s		120	-	2250	≥ 100	360 <sup>1</sup>	D	230	2900	✓	117,6	1/BLI	20	2.000
R7s		160	-	3100	≥ 100	360 <sup>1</sup>	D	230	2900	✓	117,6	1/BLI	20	2.000
R7s		230	-	4650	≥ 100	360 <sup>1</sup>	D	230	2900	✓	117,6	1/BLI	20	2.000
R7s		400	-	8550	≥ 100	360 <sup>1</sup>	D	230	2900	✓	117,6	1/BLI	20	2.000
R7s		1000	-	20000	≥ 100	360 <sup>1</sup>	D	240	2900	✓	189,1	1/BOX	20	2.000
R7s		1500	-	30000	≥ 100	360 <sup>1</sup>	D	240	2900	✓	254,0	1/BOX	20	2.000

<sup>1</sup> Messung nicht nach Halbwertswinkeln. / Mesure prise sans les angles moyens. / Measurement not to half-angles.



## Allgebrauchslampen / Lampes polyvalentes / Incandescent Lamps

						1 100010 Backofenlampe / Lampe pour four / Oven lamp <b>300°C</b>
1	2	3	4	5	6	2 100007 Kühlschranklampe / Lampe pour réfrigérateur / Refrigerator lamp
						3 100013 Dunstabzugshaubenlampe / Lampe pour hotte aspirante / Cookers hood lamp
						4 100008 Backofenlampe / Lampe pour four / Oven lamp <b>300°C</b>
						5 100011 Backofenlampe / Lampe pour four / Oven lamp <b>300°C</b>
						2 100012 Kühlschranklampe / Lampe pour réfrigérateur / Refrigerator lamp
						4 100009 Backofenlampe / Lampe pour four / Oven lamp <b>300°C</b>
						6 100014 Dunstabzugshaubenlampe / Lampe pour hotte aspirante / Cookers hood lamp

LAMPES SPECIFIQUES POUR LE QUOTIDIEN

Avec «l'interdiction des ampoules à incandescence» décidée par la Commission de l'Union européenne en 2007 et entrée en vigueur progressivement à partir de septembre 2009, les ampoules classiques disparaissent peu à peu des rayons. Elles sont remplacées par des alternatives à basse consommation basées sur les technologies LED et halogène. Certaines formes spécifiques des lampes polyvalentes peuvent toutefois continuer à être produites et vendues. On trouve, par exemple, dans cette catégorie très spécifique, les lampes pour réfrigérateur et four qui présentent un certain niveau de résistance à la température.

SPECIAL LAMPS FOR EVERYDAY USE

As a result of the so-called „ban on light bulbs“ decreed by the EU Commission in 2007 and incrementally enforced starting in September 2009, conventional incandescent bulbs have been slowly disappearing from the market. They are being replaced with energy-saving alternatives such as LED and halogen lamps. Only special forms of ordinary light bulbs may be produced and sold. These special lamps include appliance lamps for refrigerators and ovens which must have special temperature-resistant qualities.

SPEZIALLAMPEN FÜR DEN ALLTAG

Durch das sogenannte „Glühlampenverbot“, welches durch die EU-Kommission in 2007 beschlossen und ab September 2009 schrittweise in Kraft getreten ist, verschwinden herkömmliche Glühlampen nach und nach aus den Märkten. Sie werden ersetzt durch energiesparende Alternativen aus den Bereichen LED- und Halogenlampen. Einzig Spezialformen der Allgebrauchslampen dürfen bis auf Weiteres produziert und verkauft werden. Zu diesen Speziallampen gehören unter anderem Kühlschrank- und Backofenlampen, die eine besondere Temperaturresistenz aufweisen müssen.

		<b>W</b>		<b>lm</b>	<b>Ra</b>			<b>V</b>	<b>K</b>					
E14	15	-	90	≥ 98	360 <sup>1</sup>	E	240	2400	✓	22 x 48	1/BOX	20	1.000	
E14	15	-	110	≥ 98	360 <sup>1</sup>	E	240	2400	✓	26 x 60	1/BOX	20	1.000	
E14	25	-	120	≥ 98	360 <sup>1</sup>	E	240	2900	✓	20 x 115	1/BOX	20	1.000	
E14	25	-	170	≥ 98	360 <sup>1</sup>	E	240	2700	✓	45 x 77	1/BOX	20	1.000	
E14	25	-	170	≥ 98	360 <sup>1</sup>	E	240	2400	✓	26 x 60	1/BOX	20	1.000	
E14	25	-	220	≥ 98	360 <sup>1</sup>	E	240	2400	✓	26 x 60	1/BOX	20	1.000	
E14	40	-	350	≥ 98	360 <sup>1</sup>	E	240	2700	✓	45 x 79	1/BOX	20	1.000	
E14	40	-	380	≥ 98	360 <sup>1</sup>	E	240	2700	✓	25 x 84	1/BOX	20	1.000	

<sup>1</sup> Messung nicht nach Halbwertswinkeln. / Mesure prise sans les angles moyens. / Measurement not to half-angles.

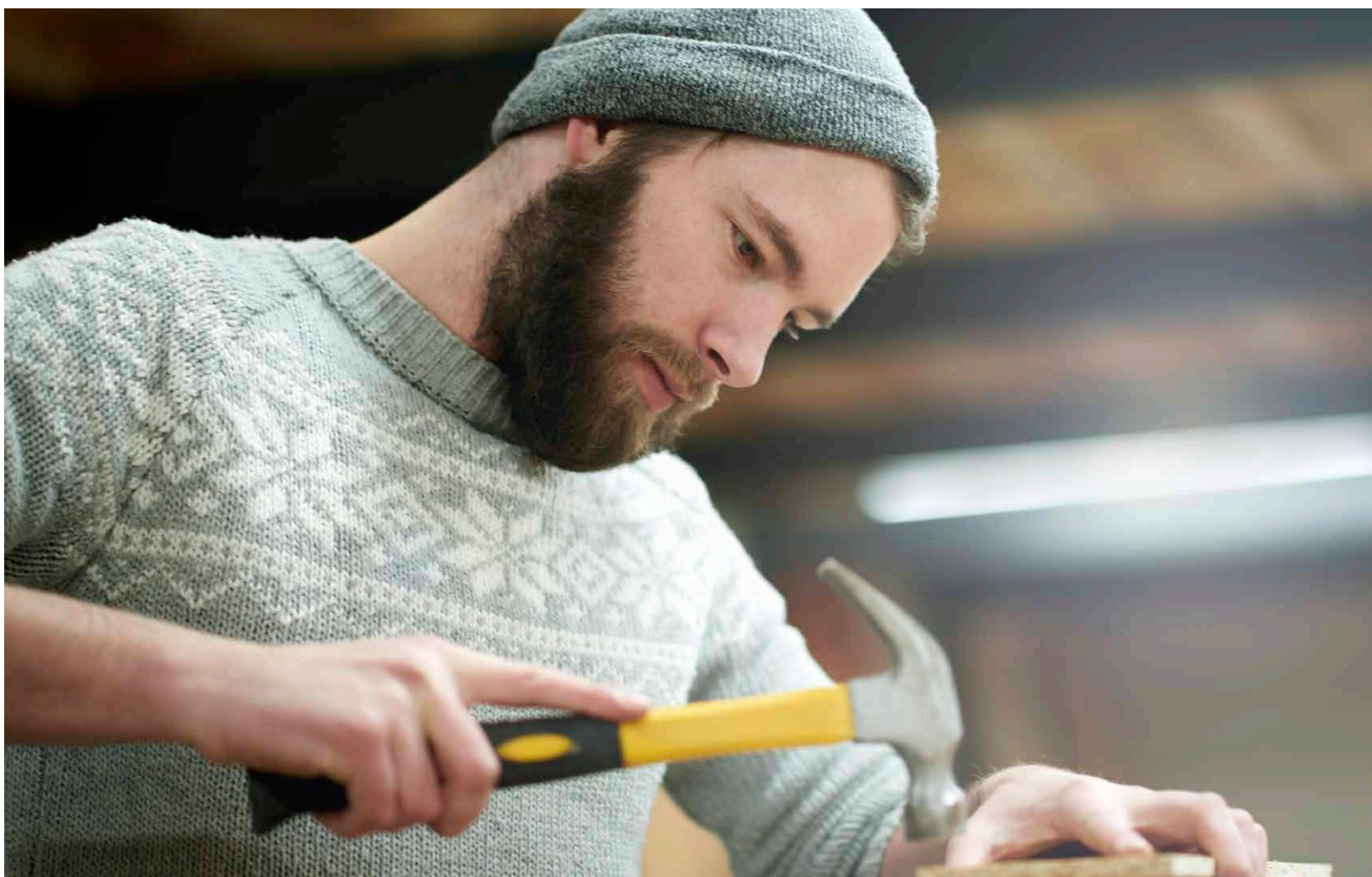

## Leuchtstofflampe / Lampe fluorescente / Fluorescent lamp

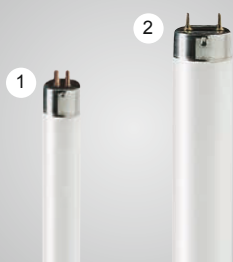

1	100000	Leuchtstofflampe / Lampe fluorescente / Fluorescent lamp <b>T5</b>
2	100001	Leuchtstofflampe / Lampe fluorescente / Fluorescent lamp <b>T8</b>
2	100002	Leuchtstofflampe / Lampe fluorescente / Fluorescent lamp <b>T8</b>
2	100003	Leuchtstofflampe / Lampe fluorescente / Fluorescent lamp <b>T8</b>
2	100004	Leuchtstofflampe / Lampe fluorescente / Fluorescent lamp <b>T8</b>
2	100005	Leuchtstofflampe / Lampe fluorescente / Fluorescent lamp <b>T8</b>
2	100006	Leuchtstofflampe / Lampe fluorescente / Fluorescent lamp <b>T8</b>

## Leuchtstofflampe / Lampe fluorescente / Fluorescent lamp



1	20600084	Leuchtstofflampe / Lampe fluorescente / Fluorescent lamp <b>T4</b>
1	20600079	Leuchtstofflampe / Lampe fluorescente / Fluorescent lamp <b>T4</b>
1	20600080	Leuchtstofflampe / Lampe fluorescente / Fluorescent lamp <b>T4</b>
1	20600081	Leuchtstofflampe / Lampe fluorescente / Fluorescent lamp <b>T4</b>
1	20600082	Leuchtstofflampe / Lampe fluorescente / Fluorescent lamp <b>T4</b>
1	20600083	Leuchtstofflampe / Lampe fluorescente / Fluorescent lamp <b>T4</b>

## ECLAIRAGE DE BASE PRATIQUE

Qu'il s'agisse du garage, d'un espace de rangement ou de la cave, les lampes fluorescentes sont utilisées à de nombreuses finalités. MÜLLER-LICHT propose, dans ce secteur, une gamme basique au meilleur prix.

## PRACTICAL BASIC LIGHTING

Whether for garage, work room or basement - fluorescent lamps are used in a wide range of applications. MÜLLER-LICHT offers a basic assortment at the best price.

# PRAKTISCHE BASISBELEUCHTUNG

Egal ob Garage, Werkraum oder Keller - Leuchtstofflampen kommen in vielen Anwendungsbereichen zum Einsatz. Hier bietet MÜLLER-LICHT ein Basissortiment zum besten Preis.

		<b>W</b>		<b>lm</b>	<b>Ra</b>			<b>V</b>	<b>K</b>					
	G5	8	-	420	≥ 80	360 <sup>1</sup>	A	-	4000	-	16 x 302,5	1/BOX	50	10.000
	G13	18	-	1350	≥ 82	360 <sup>1</sup>	A	-	4000	-	26 x 590	1/BOX	25	10.000
	G13	18	-	1350	≥ 82	360 <sup>1</sup>	A	-	3000	-	26 x 590	1/BOX	25	10.000
	G13	36	-	3350	≥ 80	360 <sup>1</sup>	A+	-	4000	-	26 x 1200	1/BOX	25	12.000
	G13	36	-	3350	≥ 82	360 <sup>1</sup>	A+	-	3000	-	26 x 1200	1/BOX	25	12.000
	G13	58	-	5220	≥ 80	360 <sup>1</sup>	A	-	3000	-	26 x 1500	1/BOX	25	10.000
	G13	58	-	5220	≥ 80	360 <sup>1</sup>	A	-	4000	-	26 x 1500	1/BOX	25	10.000

		<b>W</b>		<b>lm</b>	<b>Ra</b>			<b>V</b>	<b>K</b>					
	G5	6	-	340	≥ 80	360 <sup>1</sup>	A	-	3400	-	12 x 207	1/BOX	5	8.000
	G5	8	-	450	≥ 80	360 <sup>1</sup>	B	-	3400	-	12 x 327	1/BOX	25	8.000
	G5	12	-	670	≥ 80	360 <sup>1</sup>	B	-	3400	-	12 x 356	1/BOX	25	8.000
	G5	16	-	990	≥ 80	360 <sup>1</sup>	B	-	3400	-	12 x 455	1/BOX	25	8.000
	G5	20	-	1240	≥ 80	360 <sup>1</sup>	B	-	3400	-	12 x 554	1/BOX	25	8.000
	G5	30	-	2040	≥ 80	360 <sup>1</sup>	A	-	3400	-	12 x 750	1/BOX	25	8.000

<sup>1</sup> Messung nicht nach Halbwertswinkeln. / Mesure prise sans les angles moyens. / Measurement not to half-angles.

MÜLLER  
LICHT



Unsere LED-Accessoires

# STIMMUNGSVOLLE BELEUCHTUNG FÜR MEHR WOHNKOMFORT

Nos accessoires LED

UN ECLAIRAGE CONVIVIAL ET AGREABLE POUR  
PLUS DE CONFORT DE VIE

Our LED accessories

ATMOSPHERIC LIGHTING FOR MORE LIVING COMFORT

**iDual – MY HOME. MY LIGHT**

32

**RGB+**

36

**LED-STRIPS, NACHTLICHTER UND VIELES MEHR**

BANDES LED, VEILLEUSES ET BIEN PLUS ENCORE

LED STRIPS, NIGHT LIGHTS AND MUCH MORE

40



## iDual



1	400041 <sup>1</sup>	Miniglobe, Zusatzlampe / Lampe d'appoint mini globe / Mini Globe, add on lamp
2	400040 <sup>1</sup>	Miniglobe mit Fernbedienung, 2er-Set / Mini globe avec télécommande, Set de 2 / Mini Globe with remote control, set of 2
3	400009 <sup>1</sup>	Birne, Zusatzlampe / Ampoule d'appoint forme standard / Bulb, add on lamp
4	400008 <sup>1</sup>	Birne mit Fernbedienung, 2er-Set / Ampoule forme standard avec télécommande, Set de 2 / Bulb with remote control, set of 2
5	400052 <sup>1</sup>	Globe mit Fernbedienung / Globe avec télécommande / Globe with remote control
6	400131	Fernbedienung / Télécommande / Remote control

Tauchen Sie noch tiefer in die iDual-Welt ein und sehen Sie sich unseren Film an unter [www.mueller-licht.de/idual](http://www.mueller-licht.de/idual)

Découvrez encore plus l'univers iDual et visionnez notre film sur [www.mueller-licht.de/idual](http://www.mueller-licht.de/idual)

Delve deeper into the iDual world and watch our film at [www.mueller-licht.de/idual](http://www.mueller-licht.de/idual)



<sup>3</sup> Fernbedienung inklusive AAA Batterien sowie Halterung mit Befestigungsmaterial.

<sup>3</sup> Télécommande avec piles AAA, support et fixations incl.

<sup>3</sup> Remote control including AAA-batteries with holder and fixing accessories.

<sup>4</sup> Messung nicht nach Halbwertswinkeln.

<sup>4</sup> Mesure prise sans les angles moyens.

<sup>4</sup> Measurement not to half-angles.

## UNE REGULATION INDIVIDUELLE DE L'ÉCLAIRAGE POUR LA MAISON

Avec ses lampes LED iDual, MÜLLER-Licht propose plus de confort lumineux pour la maison. Outre un éclairage facilement réglage (lumière chaude à froide), les produits LED iDual disposent notamment d'une fonction de variation/régulation, différentes fonctions de couleur et des scènes lumineuses pré-programmées qui peuvent, par simple pression de doigt, créer une ambiance agréable pour travailler ou se détendre.

## INDIVIDUAL LIGHT CONTROL FOR YOUR HOME









MÜLLER-Licht offers even more light comfort for your home with its iDual LED lamps. In addition to outstanding general lighting (warm to cold white), the iDual LED products also offer a dimmer function, numerous color combinations and preprogrammed light scenes that create a pleasant atmosphere for work or relaxation at the push of a remote control button.

# iDual

## MY HOME. MY LIGHT.

### Individuelle Lichtsteuerung für Zuhause

MÜLLER-Licht bietet mit seinen iDual LED-Lampen noch mehr Lichtkomfort für Zuhause. Neben einer hervorragenden einstellbaren Allgemeinbeleuchtung (warm- bis kaltweiß) verfügen die iDual LED-Produkte unter anderem über eine Dimmfunktion, zahlreiche Farbfunktionen, sowie vorprogrammierte Lichtszenen, die auf Knopfdruck per Fernbedienung eine angenehme Atmosphäre zum Arbeiten oder Entspannen schaffen.

		<b>W</b>		<b>lm</b>	<b>Ra</b>			<b>V</b>	<b>K</b>				
E14	7	40	470	≥ 80	> 120 <sup>4</sup>	A+	220-240	iDual	- <sup>2</sup>	60 x 109	1/BOX	2	20.000
E14	7	40	470	≥ 80	> 120 <sup>4</sup>	A+	220-240	iDual	- <sup>2</sup>	60 x 109	2/BOX	2	20.000
E27	11	60	806	≥ 80	> 120 <sup>4</sup>	A	220-240	iDual	- <sup>2</sup>	68 x 119	1/BOX	2	20.000
E27	11	60	806	≥ 80	> 120 <sup>4</sup>	A	220-240	iDual	- <sup>2</sup>	68 x 119	2/BOX	2	20.000
E27	16	75	1055	≥ 80	> 120 <sup>4</sup>	A	220-240	iDual	- <sup>2</sup>	100 x 138	1/BOX	2	20.000
-	-	-	-	-	> 120 <sup>4</sup>	-	-	-	-	57 x 125 x 25	1/BOX	2	-

### MÜLLER-LICHT unterstützt Sie optimal in Ihren Abverkäufen: Mit dem hochwertigen iDual-Holzdisplay.

Weitere Informationen dazu finden Sie auf Seite 89.

### MÜLLER-LICHT vous aide à vendre: Avec des présentoirs en bois iDual de qualité.

Vous trouverez plus d'informations page 89.

### MÜLLER-LICHT gives you optimal support for your sales activities: With the high-quality iDual wooden display

Further information can be found on page 89.



<sup>1</sup> Die technischen Werte sowie das Energieeffizienzlabel beziehen sich auf Messungen bei Arbeitslicht (4000 K Farbtemperatur, neutralweiß ungedimmt). Die Angaben sind bezogen auf jeweils ein Leuchtmittel.

<sup>1</sup> Les données techniques ainsi que les labels énergétiques sont élaborés à partir de mesures de lumière de travail (température de couleur de 4000 K, blanc neutre sans régulation). Les données se rapportent à chaque fois à un système d'éclairage.

<sup>1</sup> Technical data and the energy efficiency label are based on measurements at working light (4000 K color temperature, neutral white without dimming). The data is based per one lamp.

<sup>2</sup> Dimmbar nur mit beiliegender Fernbedienung, nicht dimmbar über konventionelle Dimmer.

<sup>2</sup> Dimmable uniquement grâce à la télécommande ci-jointe, non dimmable par variateur conventionnel.

<sup>2</sup> Dimmable only with the accompanying remote control, not dimmable with conventional dimmers.

## 400152<sup>1</sup> Tischleuchte, Kugel / Lampe de table, boule / Table lamp, ball



Tischleuchte, Kugel, Milchglasgehäuse, weiß  
Lampe de table, boule, boîtier en verre dépoli, blanc  
Table lamp, ball, satin glass cover, white

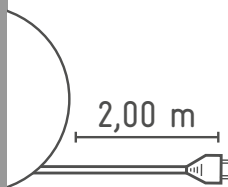

Hinweise zur Energieeffizienzklasse auf Seite 92. / Les informations sur les catégories d'efficacité énergétique sont indiquées page 92. / Notes on Energy Efficiency Class on page 92.

## 400153<sup>1</sup> Tischleuchte, Projektor / Lampe de table, Projecteur / Table lamp, Projector



Tischleuchte, Projektor S  
Lampe de table, Projecteur S  
Table lamp, Projector S

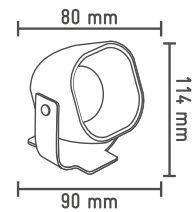
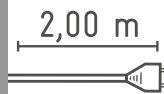

Hinweise zur Energieeffizienzklasse auf Seite 92. / Les informations sur les catégories d'efficacité énergétique sont indiquées page 92. / Notes on Energy Efficiency Class on page 92.

## 400154<sup>1</sup> Clip-Licht / Lumière clip / Clip-on lights



Clip-Licht  
Lumière clip  
Clip-on lights

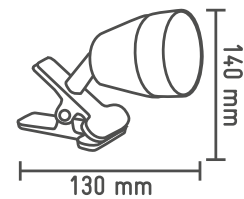
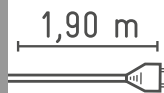

Hinweise zur Energieeffizienzklasse auf Seite 92. / Les informations sur les catégories d'efficacité énergétique sont indiquées page 92. / Notes on Energy Efficiency Class on page 92.

<sup>3</sup> Fernbedienung inklusive AAA Batterien sowie Halterung mit Befestigungsmaterial.

<sup>3</sup> Télécommande avec piles AAA, support et fixations incl.

<sup>3</sup> Remote control including AAA-batteries with holder and fixing accessories.

<sup>4</sup> Messung nicht nach Halbwertswinkeln.

<sup>4</sup> Mesure prise sans les angles moyens.

<sup>4</sup> Measurement not to half-angles.

W	lm	Ra	°		V	K					
8,5	500	≥ 80	280 <sup>4</sup>		220-240	iDual	- <sup>2</sup>	200 x 191	1/BOX	2	20.000

W	lm	Ra	°		V	K					
8,5	380	≥ 80	100 <sup>4</sup>		220-240	iDual	- <sup>2</sup>	80 x 114 x 90	1/BOX	2	20.000

W	lm	Ra	°		V	K					
6,8	300	≥ 80	70 <sup>4</sup>		220-240	iDual	- <sup>2</sup>	140 x 130	1/BOX	2	20.000

<sup>1</sup> Die technischen Werte sowie das Energieeffizienzlabel beziehen sich auf Messungen bei Arbeitslicht (4000 K Farbtemperatur, neutralweiß, ungedimmt).

<sup>1</sup> Les données techniques ainsi que les labels énergétiques sont élaborés à partir de mesures de lumière de travail (température de couleur de 4000 K, blanc neutre sans régulation).

<sup>1</sup> Technical data and the energy efficiency label are based on measurements at working light (4000 K color temperature, neutral white without dimming).

<sup>2</sup> Dimmbar nur mit beiliegender Fernbedienung, nicht dimmbar über konventionelle Dimmer.

<sup>2</sup> Dimmable uniquement grâce à la télécommande ci-jointe, non dimmable par variateur conventionnel.

<sup>2</sup> Dimmable only with the accompanying remote control, not dimmable with conventional dimmers.



RGB+ warmweiß / RGB+ blanc chaud / RGB+ warmwhite



1 400005<sup>1</sup> Birne / Forme standard / Bulb

2 400051<sup>1</sup> Globe / Globe / Globe

<sup>3</sup> Fernbedienung inklusive CR 2025 Batterien sowie Halterung mit Befestigungsmaterial.

<sup>3</sup> Télécommande avec piles CR 2025, support et fixations incl.

<sup>3</sup> Remote control including CR 2025-batteries with holder and fixing accessories.

<sup>4</sup> Messung nicht nach Halbwertswinkeln.

<sup>4</sup> Mesure prise sans les angles moyens.

<sup>4</sup> Measurement not to half-angles.

## LUMIERE DE BASE AVEC LA COULEUR EN PLUS















Ajoutez de la couleur sans faire aucun effort, à l'aide tout simplement de la télécommande: les produits LED RGB+ de MÜLLER-LICHT allient couleurs vives et lumière LED blanche chaude. Le point fort de ces solutions réside dans la combinaison de LED blanches chaudes classiques et de LED de couleur bleue, verte et rouge. Ainsi, ces produits conviennent aussi bien à l'éclairage basique à lumière blanche qu'à l'éclairage d'ambiance avec différentes nuances de couleur.

## BASIC LIGHTING WITH A COLORFUL BONUS

Bring color into play with the convenience of a remote control: LED RGB+ products from MÜLLER-LICHT combine powerful colors with a warmwhite LED light. The bonus with these products is the combination of conventional warm white LEDs with additional red, green and blue LEDs. As a result, these products are suitable for basic lighting with pure white light and for mood lighting in various color nuances.

# GRUNDBELEUCHTUNG MIT DEM FARBLICHEN PLUS

Bringen Sie ganz bequem per Fernbedienung Farbe ins Spiel: LED RGB+ Produkte von MÜLLER-LICHT verbinden kraftvolle Farben mit einem warmweißen LED-Licht. Das Plus bei den Produkten liegt in der Kombination von herkömmlichen warmweißen LEDs mit zusätzlichen roten, grünen und blauen LEDs. Dadurch sind die Produkte sowohl zur Grundbeleuchtung mit reinweißem Licht als auch zur Stimmungsbeleuchtung in verschiedenen Farbnuancen geeignet.

														
E27	7,5	40	470	≥ 80	130	A	220-240	RGB+ 3000 K	- <sup>2</sup>	61 x 105	1/BOX	2	20.000	
E27	13	60	806	≥ 80	> 120 <sup>4</sup>	A	220-240	RGB+ 3000 K	- <sup>2</sup>	100 x 167	1/BOX	2	20.000	

<sup>1</sup> Die technischen Werte beziehen sich auf Messungen bei warmweißem Licht (3000 K Farbtemperatur, warmweiß ungedimmt).

<sup>1</sup> Les données techniques sont élaborées à partir de mesures de lumière blanche chaude (température de couleur 3000 K, blanc chaud sans régulation).

<sup>1</sup> Technical data is based on measurements at warmwhite light (3000 K color temperature, warmwhite without dimming).

<sup>2</sup> Dimmbar nur mit beiliegender Fernbedienung, nicht dimmbar über konventionelle Dimmer.

<sup>2</sup> Dimmable uniquement grâce à la télécommande ci-jointe, non dimmable par variateur conventionnel.

<sup>2</sup> Dimmable only with the accompanying remote control, not dimmable with conventional dimmers.

## 400075<sup>1</sup> Tischleuchte, Zylinder / Lampe de table, cylindre / Table lamp, cylinder



Tischleuchte, Zylinder, Milchglasgehäuse, weiß  
Lampe de table, cylindre, boîtier en verre dépoli, blanc  
Table lamp, cylinder, satin glass cover, white

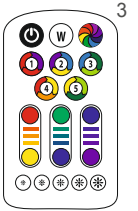
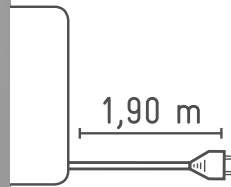

Hinweise zur Energieeffizienzklasse auf Seite 92. / Les informations sur les catégories d'efficacité énergétique sont indiquées page 92. / Notes on Energy Efficiency Class on page 92.

## 400076<sup>1</sup> Tischleuchte, Kugel / Lampe de table, boule / Table lamp, ball



Tischleuchte, Kugel, Milchglasgehäuse, weiß  
Lampe de table, boule, boîtier en verre dépoli, blanc  
Table lamp, ball, satin glass cover, white

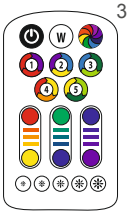
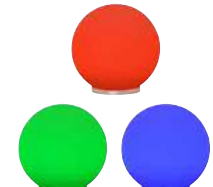
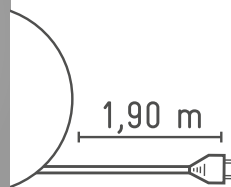

Hinweise zur Energieeffizienzklasse auf Seite 92. / Les informations sur les catégories d'efficacité énergétique sont indiquées page 92. / Notes on Energy Efficiency Class on page 92.

## 400074<sup>1</sup> Einbauleuchte / Lumière intégrée / Downlight

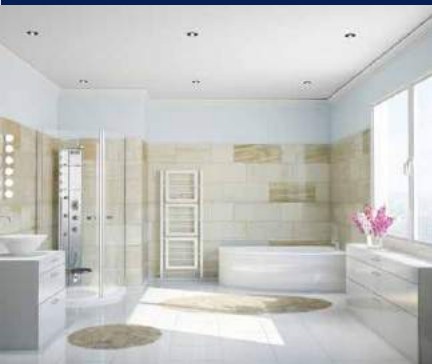

Einbauleuchte, Kunststoff, weiß  
Lumière intégrée, plastique  
Downlight, plastic, white

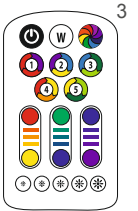
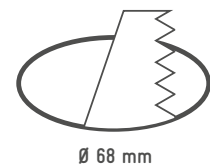
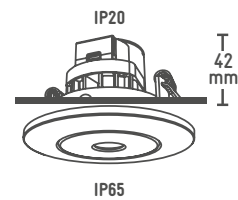

Hinweise zur Energieeffizienzklasse auf Seite 92. / Les informations sur les catégories d'efficacité énergétique sont indiquées page 92. / Notes on Energy Efficiency Class on page 92.

<sup>3</sup> Fernbedienung inklusive CR 2025 Batterien sowie Halterung mit Befestigungsmaterial.







<sup>3</sup> Télécommande avec piles CR 2025, support et fixations incl.







<sup>3</sup> Remote control including CR 2025-batteries with holder and fixing accessories.







<sup>4</sup> Messung nicht nach Halbwertswinkeln.

<sup>4</sup> Mesure prise sans les angles moyens.

<sup>4</sup> Measurement not to half-angles.

	W	lm	Ra	°		V	K					
	5,5	300	≥ 82	280 <sup>4</sup>		220-240	RGB+ warmwhite	- <sup>2</sup>	137 x 258	1/BOX	2	20.000

	W	lm	Ra	°		V	K					
	5,5	300	≥ 80	280 <sup>4</sup>		220-240	RGB+ warmwhite	- <sup>2</sup>	200 x 198	1/BOX	2	20.000

	W	lm	Ra	°		V	K					
	7,5	345	≥ 80	100 <sup>4</sup>		230	RGB+ warmwhite	- <sup>2</sup>	85 x 45	1/BOX	2	25.000

<sup>1</sup> Die technischen Werte beziehen sich auf Messungen bei warmweißen Licht (3000 K Farbtemperatur, warmweiß ungedimmt).

<sup>1</sup> Les données techniques sont élaborées à partir de mesures de lumière blanche chaude (température de couleur 3000 K, blanc chaud sans régulation).

<sup>1</sup> Technical data is based on measurements at warmwhite light (3000 K color temperature, warmwhite without dimming).

<sup>2</sup> Dimmbar nur mit beiliegender Fernbedienung, nicht dimmbar über konventionelle Dimmer.

<sup>2</sup> Dimmable uniquement grâce à la télécommande ci-jointe, non dimmable par variateur conventionnel.

<sup>2</sup> Dimmable only with the accompanying remote control, not dimmable with conventional dimmers.



## LED-STRIPS, NACHTLICHTER UND VIELES MEHR

Die dekorative Beleuchtung von MÜLLER-LICHT bringt mit ihrem Sortiment an Akzent-, Farb- und Orientierungslichtern Stimmung nach Hause. Egal ob LED-Strip, LED-Lichtleiste oder Nachtlcht – unsere Produkte setzen moderne Lichtakzente in verschiedenen Wohnbereichen.

### BANDES LED, VEILLEUSES ET BIEN PLUS ENCORE

L'éclairage décoratif de MÜLLER-LICHT apporte, avec ses différentes solutions, une lumière d'ambiance, de la couleur et de la vie dans la maison. Qu'il s'agisse de bandes LED, de barres lumineuses LED ou de veilleuses, nos produits apportent des touches lumineuses très tendances dans différents types d'intérieur.

### LED STRIPS, NIGHT LIGHTS AND MUCH MORE

The decorative lighting from MÜLLER-LICHT provides the right mood in your home with accent, color and orientation lighting. Whether it is an LED strip or night light – our products provide modern lighting accents in a variety of living areas.

## 400090 LED-Strip, warmweiß / Bande LED, blanc chaud / LED Strip, warmwhite



LED-Strip, warmweiß  
Bande LED, blanc chaud  
LED Strip, warmwhite



- 1 Verbinder, 10 cm  
Connecteurs, 10 cm  
Connectors, 10 cm
- 2 Netzadapter mit Leitung, 150 cm  
Adaptateur réseau avec câble,  
150 cm  
Mains adapters with cable,  
150 cm

Hinweise zur Energieeffizienzklasse auf Seite 92. / Les informations sur les catégories d'efficacité énergétique sont indiquées page 92. / Notes on Energy Efficiency Class on page 92.

## 400091 LED-Strip, neutralweiß / Bande LED, blanc neutre / LED Strip, neutralwhite



LED-Strip neutralweiß  
Bande LED, blanc neutre  
LED Strip, neutralwhite



- 1 Verbinder, 10 cm  
Connecteurs, 10 cm  
Connectors, 10 cm
- 2 Netzadapter mit Leitung, 150 cm  
Adaptateur réseau avec câble,  
150 cm  
Mains adapters with cable,  
150 cm

Hinweise zur Energieeffizienzklasse auf Seite 92. / Les informations sur les catégories d'efficacité énergétique sont indiquées page 92. / Notes on Energy Efficiency Class on page 92.

## 400089 LED-Strip, Schwarzlicht / Bande LED, lumière noire / LED Strip, black light



LED-Strip Schwarzlicht  
Bande LED, lumière noire  
LED Strip, black light



- 1 Verbinder, 10 cm  
Connecteurs, 10 cm  
Connectors, 10 cm
- 2 Netzadapter mit Leitung, 150 cm  
Adaptateur réseau avec câble,  
150 cm  
Mains adapters with cable,  
150 cm

Hinweise zur Energieeffizienzklasse auf Seite 92. / Les informations sur les catégories d'efficacité énergétique sont indiquées page 92. / Notes on Energy Efficiency Class on page 92.

## 400225<sup>1</sup> LED-Bedlight Sensor, warmweiß / LED-Bedlight-Sensor, blanc chaud / LED-Bedlight Sensor, warmwhite



LED-Bedlight Sensor, warmweiß (2er-Set)  
LED-Bedlight-Sensor, blanc chaud (Set de 2)  
LED-Bedlight Sensor, warmwhite (set of 2)



- 1 Sensor  
Capteur  
Sensor
- 2 Netzadapter mit Leitung, 150 cm  
Adaptateur réseau avec câble,  
150 cm  
Mains adapters with cable,  
150 cm

Hinweise zur Energieeffizienzklasse auf Seite 92. / Les informations sur les catégories d'efficacité énergétique sont indiquées page 92. / Notes on Energy Efficiency Class on page 92.

NEW

## LED-STRIPS, NACHTLICHTER UND VIELES MEHR

BANDES LED, VEILLEUSES ET BIEN PLUS ENCORE / LED STRIPS, NIGHT LIGHTS AND MUCH MORE

W	lm	Ra	°		V	K		mm	Box/ Blister		
20	1100	≥ 80	-		230	3500	-	5000	1/BOX	4	10.000
			<ul style="list-style-type: none"> <li>· Geeignet zur indirekten Beleuchtung in warmweißem Licht</li> <li>· Kürzbar an festgelegten Markierungspunkten</li> <li>· Flexibel und selbstklebend</li> <li>· Einfaches Verlegen durch mitgelieferte Verbinder</li> </ul>			<ul style="list-style-type: none"> <li>· Idéal pour l'éclairage indirect avec de la lumière blanche chaude</li> <li>· Rétractable au niveau des points de marquage indiqués</li> <li>· Flexible et autocollant</li> <li>· Installation simple grâce aux connecteurs fournis</li> </ul>			<ul style="list-style-type: none"> <li>· Suitable for indirect lighting with warmwhite light</li> <li>· Can be shortened at the specified marks</li> <li>· Flexible and self-adhering</li> <li>· Simple installation due to supplied connectors</li> </ul>		
20	1100	≥ 80	-		230	5400	-	5000	1/BOX	4	10.000
			<ul style="list-style-type: none"> <li>· Geeignet zur indirekten Beleuchtung in neutralweißem Licht</li> <li>· Kürzbar an festgelegten Markierungspunkten</li> <li>· Flexibel und selbstklebend</li> <li>· Einfaches Verlegen durch mitgelieferte Verbinder</li> </ul>			<ul style="list-style-type: none"> <li>· Idéal pour l'éclairage indirect avec de la lumière blanche neutre</li> <li>· Rétractable au niveau des points de marquage indiqués</li> <li>· Flexible et autocollant</li> <li>· Installation simple grâce aux connecteurs fournis</li> </ul>			<ul style="list-style-type: none"> <li>· Suitable for indirect lighting with neutralwhite light</li> <li>· Can be shortened at the specified marks</li> <li>· Flexible and self-adhering</li> <li>· Simple installation due to supplied connectors</li> </ul>		
20	10	-	-		230	Black light	-	5000	1/BOX	4	10.000
			<ul style="list-style-type: none"> <li>· Geeignet zur indirekten Beleuchtung in Schwarzlicht</li> <li>· Kürzbar an festgelegten Markierungspunkten</li> <li>· Flexibel und selbstklebend</li> <li>· Einfaches Verlegen durch mitgelieferte Verbinder</li> </ul>			<ul style="list-style-type: none"> <li>· Idéal pour l'éclairage indirect, lumière noire</li> <li>· Rétractable au niveau des points de marquage indiqués</li> <li>· Flexible et autocollant</li> <li>· Installation simple grâce aux connecteurs fournis</li> </ul>			<ul style="list-style-type: none"> <li>· Suitable for indirect lighting with black light</li> <li>· Can be shortened at the specified marks</li> <li>· Flexible and self-adhering</li> <li>· Simple installation due to supplied connectors</li> </ul>		
7	430	80	-		12	3000	-	2x 1500	1/BOX	4	10.000
			<ul style="list-style-type: none"> <li>· Geeignet zur indirekten Beleuchtung</li> <li>· Flexibel und selbstklebend</li> <li>· Einfache Befestigung durch mitgelieferte Halteclips</li> <li>· Speziell geeignet für die Montage am Bett</li> <li>· Mit Bewegungs- und Dämmerungssensor</li> <li>· Einstellbare Zeit</li> </ul>			<ul style="list-style-type: none"> <li>· Idéal pour l'éclairage indirect</li> <li>· Flexible et autocollant</li> <li>· Installation simple grâce aux clips de maintien fournis</li> <li>· Spécialement conçu pour l'installation sur un lit</li> <li>· Avec capteur de mouvement et crépuscule</li> <li>· Temps réglable</li> </ul>			<ul style="list-style-type: none"> <li>· Suitable for indirect lighting</li> <li>· Flexible and self-adhesive</li> <li>· Simple fixing by included holder clips</li> <li>· Especially suitable for mounting on bed</li> <li>· With movement and twilight sensor</li> <li>· Adjustable time</li> </ul>		

<sup>1</sup> Verfügbar ab Quartal 3. / Commercialisé à partir du 3<sup>ème</sup> trimestre. / Available from quarter 3.

## 400226<sup>2</sup> LED-Bedlight Sensor, warmweiß / LED-Bedlight Sensor, blanc chaud / LED-Bedlight Sensor, warmwhite



NEW



LED-Bedlight Sensor, warmweiß (1er-Set)  
LED-Bedlight-Sensor, blanc chaud (set unique)  
LED-Bedlight Sensor, warmwhite (set of 2)



- 1 Sensor  
Capteur  
Sensor
- 2 Netzadapter mit Leitung, 150 cm  
Adaptateur réseau avec câble,  
150 cm  
Mains adapters with cable,  
150 cm

Hinweise zur Energieeffizienzklasse auf Seite 92. / Les informations sur les catégories d'efficacité énergétique sont indiquées page 92. / Notes on Energy Efficiency Class on page 92.

## 400092 LED-Strip, RGB / Bande LED, RGB / LED Strip, RGB



LED-Strip, Farbwechsel RGB  
Bande LED, alternance de couleurs, RGB  
LED Strip, RGB color-changing



- 1 Verbinder  
Connecteurs  
Connectors
- 2 Netzadapter mit Leitung  
Adaptateur réseau avec câble  
Line adapter with cable
- 3 Fernbedienung  
Télécommande  
Remote control
- 4 Kontaktbrücken  
Ponts de contact  
Contact bridges
- 5 Steuereinheit mit IR-Empfänger  
Unité de commande  
avec récepteur IR  
Repeater with  
IR-receiver

Hinweise zur Energieeffizienzklasse auf Seite 92. / Les informations sur les catégories d'efficacité énergétique sont indiquées page 92. / Notes on Energy Efficiency Class on page 92.

## 400093 LED-Strip, RGB digital / Bande LED, RGB numérique / LED Strip, RGB digital



LED-Strip, Farbwechsel RGB digital  
Bande LED, alternance de couleurs, RGB numérique  
LED Strip, RGB digital color-changing



- 1 Fernbedienung  
Télécommande  
Remote control
- 2 Netzadapter mit Leitung  
Adaptateur réseau avec câble  
Line adapter with cable
- 3 Kontaktbrücken  
Ponts de contact  
Contact bridges
- 4 Steuereinheit mit IR-Empfänger  
Unité de commande  
avec récepteur IR  
Repeater with  
IR-receiver
- 5 Verbinder  
Connecteurs  
Connectors

Hinweise zur Energieeffizienzklasse auf Seite 92. / Les informations sur les catégories d'efficacité énergétique sont indiquées page 92. / Notes on Energy Efficiency Class on page 92.

## 400094 LED-Strip, RGB, Outdoor IP44 / Bande LED, RGB, Outdoor IP44 / LED Strip, RGB, outdoor IP44



LED-Strip Farbwechsel RGB, Outdoor IP44  
Bande LED, alternance de couleurs RGB, Outdoor IP44  
LED Strip, RGB color-changing, outdoor IP44



- 1 Netzadapter mit Leitung  
Adaptateur réseau avec câble  
Line adapter with cable
- 2 Fernbedienung  
Télécommande  
Remote control
- 3 Schrauben  
Vis  
Screws
- 4 Steuereinheit mit IR-Empfänger  
Unité de commande  
avec récepteur IR  
Repeater with  
IR-receiver

Hinweise zur Energieeffizienzklasse auf Seite 92. / Les informations sur les catégories d'efficacité énergétique sont indiquées page 92. / Notes on Energy Efficiency Class on page 92.

<sup>2</sup> Verfügbar ab Quartal 3. / Commercialisé à partir du 3<sup>ème</sup> trimestre. / Available from quarter 3.

## LED-STRIPS, NACHTLICHTER UND VIELES MEHR

BANDES LED, VEILLEUSES ET BIEN PLUS ENCORE / LED STRIPS, NIGHT LIGHTS AND MUCH MORE

W	lm	Ra	°		V	K					
4,5	200	80	-	 A++ A+ A	230	3000	-	1500	1/BOX	4	10.000
			<ul style="list-style-type: none"> <li>· Geeignet zur indirekten Beleuchtung</li> <li>· Flexibel und selbstklebend</li> <li>· Einfache Befestigung durch mitgelieferte Halteclips</li> <li>· Speziell geeignet für die Montage am Bett</li> <li>· Mit Bewegungs- und Dämmerungssensor</li> <li>· Einstellbare Zeit</li> </ul>			<ul style="list-style-type: none"> <li>· Idéal pour l'éclairage indirect</li> <li>· Flexible et autocollant</li> <li>· Installation simple grâce aux clips de maintien fournis</li> <li>· Spécialement conçu pour l'installation sur un lit</li> <li>· Avec capteur de mouvement et crépuscule</li> <li>· Temps réglable</li> </ul>			<ul style="list-style-type: none"> <li>· Suitable for indirect lighting</li> <li>· Flexible and self-adhesive</li> <li>· Simple fixing by included holder clips</li> <li>· Especially suitable for mounting on bed</li> <li>· With movement and twilight sensor</li> <li>· Adjustable time</li> </ul>		
24	320			 A++ A+ A	230	RGB	- <sup>1</sup>	5000	1/BOX	4	10.000
			<ul style="list-style-type: none"> <li>· Geeignet zur indirekten farbigen Beleuchtung</li> <li>· Steuerung durch Fernbedienung mit Infrarotsensor</li> <li>· Kürzbar an festgelegten Markierungspunkten</li> <li>· Flexibel und selbstklebend</li> <li>· Einfaches Verlegen durch mitgelieferte Verbinder</li> <li>· Fernbedienung inklusive CR 2025 Batterien sowie Halterung mit Befestigungsmaterial</li> </ul>			<ul style="list-style-type: none"> <li>· Idéal pour l'éclairage en couleur indirect</li> <li>· Contrôle par télécommande avec capteur infrarouge</li> <li>· Rétractable au niveau des points de marquage indiqués</li> <li>· Flexible et autocollant</li> <li>· Installation simple grâce aux connecteurs fournis</li> <li>· Télécommande avec piles CR 2025, support et fixations incl.</li> </ul>			<ul style="list-style-type: none"> <li>· Suitable for indirect color lighting</li> <li>· Controlled by remote control with infrared sensor</li> <li>· Can be shortened at the specified marks</li> <li>· Flexible and self-adhering</li> <li>· Simple installation due to supplied connectors</li> <li>· Remote control including CR 2025-batteries with holder and fixing accessories</li> </ul>		
17	195			 A++ A+ A	230	RGB digital	- <sup>1</sup>	5000	1/BOX	4	10.000
			<ul style="list-style-type: none"> <li>· Geeignet zur indirekten farbigen Beleuchtung</li> <li>· Steuerung durch Fernbedienung mit Infrarotsensor</li> <li>· Kürzbar an festgelegten Markierungspunkten</li> <li>· Flexibel und selbstklebend</li> <li>· Einfaches Verlegen durch mitgelieferte Verbinder</li> <li>· Fernbedienung inklusive CR 2025 Batterien sowie Halterung mit Befestigungsmaterial</li> </ul>			<ul style="list-style-type: none"> <li>· Idéal pour l'éclairage en couleur indirect</li> <li>· Contrôle par télécommande avec capteur infrarouge</li> <li>· Rétractable au niveau des points de marquage indiqués</li> <li>· Flexible et autocollant</li> <li>· Installation simple grâce aux connecteurs fournis</li> <li>· Télécommande avec piles CR 2025, support et fixations incl.</li> </ul>			<ul style="list-style-type: none"> <li>· Suitable for indirect color lighting</li> <li>· Controlled by remote control with infrared sensor</li> <li>· Can be shortened at the specified marks</li> <li>· Flexible and self-adhering</li> <li>· Simple installation due to supplied connectors</li> <li>· Remote control including CR 2025-batteries with holder and fixing accessories</li> </ul>		
24	300	≥ 67		 A++ A+ A	230	RGB	- <sup>1</sup>	5000	1/BOX	4	10.000
			<ul style="list-style-type: none"> <li>· Geeignet zur indirekten farbigen Beleuchtung</li> <li>· Spritzwassergeschützt, für Außeneinsatz</li> <li>· Steuerung durch Fernbedienung mit Infrarotsensor</li> <li>· Nicht teilbar</li> <li>· Einfache Montage durch mitgelieferte Halterungen</li> <li>· Fernbedienung inklusive CR 2025 Batterien sowie Halterung mit Befestigungsmaterial</li> </ul>			<ul style="list-style-type: none"> <li>· Idéal pour l'éclairage en couleur indirect</li> <li>· Protection contre les éclaboussures, pour l'extérieur</li> <li>· Contrôle par télécommande avec capteur infrarouge</li> <li>· Non séparable</li> <li>· Installation simple grâce aux supports fournis</li> <li>· Télécommande avec piles CR 2025, support et fixations incl.</li> </ul>			<ul style="list-style-type: none"> <li>· Suitable for indirect colorful lighting</li> <li>· Splash water protected, for outdoor</li> <li>· Controlled by remote control with infrared sensor</li> <li>· Indivisible</li> <li>· Simple mounting due to delivered bracket</li> <li>· Remote control including CR 2025-batteries with holder and fixing accessories</li> </ul>		

<sup>1</sup> Dimmbar nur mit beiliegender Fernbedienung, nicht dimmbar über konventionelle Dimmer.

<sup>1</sup> Dimmable uniquement grâce à la télécommande ci-jointe, non dimmable par variateur conventionnel.

<sup>1</sup> Dimmable only with the accompanying remote control, not dimmable with conventional dimmers.

## 400086 LED Lichtleiste, warmweiß / Barre lumineuse LED, blanc chaud / LED rigid bar, warmwhite



LED Lichtleiste, warmweiß  
Barre lumineuse LED, blanc chaud  
LED rigid bar, warmwhite

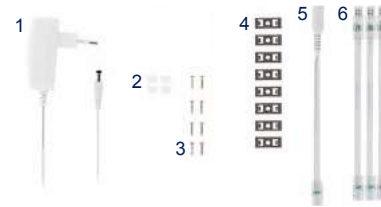

- 1 Netzadapter mit Leitung, 150 cm  
Adaptateur réseau avec câble, 150 cm  
Mains adapters with cable, 150 cm
- 2 Endkappen  
Embout  
End caps
- 3 Schrauben  
Vis  
Screws

Hinweise zur Energieeffizienzklasse auf Seite 92. / Les informations sur les catégories d'efficacité énergétique sont indiquées page 92. / Notes on Energy Efficiency Class on page 92.

## 400087 LED Lichtleiste, neutralweiß / Barre lumineuse LED, blanc neutre / LED rigid bar, neutralwhite



LED Lichtleiste, neutralweiß  
Barre lumineuse LED, blanc neutre  
LED rigid bar, neutralwhite

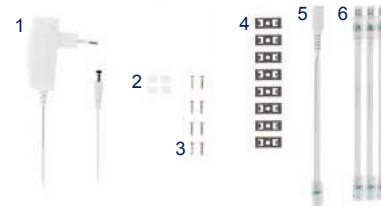

- 1 Netzadapter mit Leitung, 150 cm  
Adaptateur réseau avec câble, 150 cm  
Mains adapters with cable, 150 cm
- 2 Endkappen  
Embout  
End caps
- 3 Schrauben  
Vis  
Screws

Hinweise zur Energieeffizienzklasse auf Seite 92. / Les informations sur les catégories d'efficacité énergétique sont indiquées page 92. / Notes on Energy Efficiency Class on page 92.

## 400085 LED Lichtleiste, Schwarzlicht / Barre lumineuse LED, lumière noire / LED rigid bar, black light



LED Lichtleiste, Schwarzlicht  
Barre lumineuse LED, lumière noire  
LED rigid bar, black light

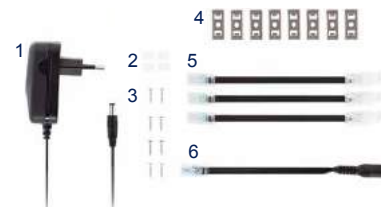

- 1 Netzadapter mit Leitung, 150 cm  
Adaptateur réseau avec câble, 150 cm  
Mains adapters with cable, 150 cm
- 2 Endkappen  
Embout  
End caps
- 3 Schrauben  
Vis  
Screws

Hinweise zur Energieeffizienzklasse auf Seite 92. / Les informations sur les catégories d'efficacité énergétique sont indiquées page 92. / Notes on Energy Efficiency Class on page 92.

## 400088 LED Lichtleiste, RGB / Barre lumineuse LED, RGB / LED rigid bar, RGB

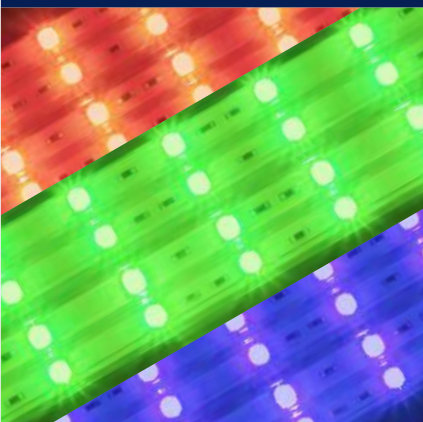

LED Lichtleiste, Farbwechsel RGB  
Barre lumineuse LED, alternance de couleurs RGB  
LED rigid bar, color changing RGB



- 1 Netzadapter mit Leitung  
Adaptateur réseau avec câble  
Mains adapters with cable
- 2 Verbinder  
Connecteurs  
Connectors
- 3 Halteclips  
Clips de maintien  
Holding clips
- 4 Schrauben  
Vis  
Screws

Hinweise zur Energieeffizienzklasse auf Seite 92. / Les informations sur les catégories d'efficacité énergétique sont indiquées page 92. / Notes on Energy Efficiency Class on page 92.

## LED-STRIPS, NACHTLICHTER UND VIELES MEHR

BANDES LED, VEILLEUSES ET BIEN PLUS ENCORE / LED STRIPS, NIGHT LIGHTS AND MUCH MORE

W	lm	Ra	°		V	K		mm	Box/ Blister		
15	750	≥ 80	-		230	3000	-	4 x 400	1/BOX	4	10.000
<b>4 Halteclips</b> Clips de maintien Holding clips <b>5 Netzteilverbinder</b> Bloc d'alimentation Connector to line adapter <b>6 Verbinder, 15 cm</b> Connecteurs, 15 cm Connectors, 15 cm			<ul style="list-style-type: none"> <li>· Geeignet zur indirekten Beleuchtung</li> <li>· Besonders geeignet zur Montage unter Hängeschränken oder an geraden Wand- und Möbelflächen</li> <li>· Einfaches Verlegen durch mitgelieferte Verbinder</li> </ul>			<ul style="list-style-type: none"> <li>· Idéal pour l'éclairage indirect</li> <li>· Idéal pour les meubles suspendus ou surfaces de meuble ou murs droits</li> <li>· Installation simple grâce aux connecteurs fournis</li> </ul>			<ul style="list-style-type: none"> <li>· Suitable for indirect lighting</li> <li>· Particularly suitable for mounting under cupboards or at straight walls or furniture</li> <li>· Simple mounting due to provided connectors</li> </ul>		
15	750	≥ 80	-		230	4000	-	4 x 400	1/BOX	4	10.000
<b>4 Halteclips</b> Clips de maintien Holding clips <b>5 Netzteilverbinder</b> Bloc d'alimentation Connector to line adapter <b>6 Verbinder, 15 cm</b> Connecteurs, 15 cm Connectors, 15 cm			<ul style="list-style-type: none"> <li>· Geeignet zur indirekten Beleuchtung</li> <li>· Besonders geeignet zur Montage unter Hängeschränken oder an geraden Wand- und Möbelflächen</li> <li>· Einfaches Verlegen durch mitgelieferte Verbinder</li> </ul>			<ul style="list-style-type: none"> <li>· Idéal pour l'éclairage indirect</li> <li>· Idéal pour les meubles suspendus ou surfaces de meuble ou murs droits</li> <li>· Installation simple grâce aux connecteurs fournis</li> </ul>			<ul style="list-style-type: none"> <li>· Suitable for indirect lighting</li> <li>· Particularly suitable for mounting under cupboards or at straight walls or furniture</li> <li>· Simple mounting due to provided connectors</li> </ul>		
12	-	-	-		230	Black light	-	4 x 400	1/BOX	4	10.000
<b>4 Halteclips</b> Clips de maintien Holding clips <b>5 Verbinder, 15 cm</b> Connecteurs, 15 cm Connectors, 15 cm <b>6 Netzteilverbinder</b> Bloc d'alimentation Connector to line adapter			<ul style="list-style-type: none"> <li>· Geeignet zur indirekten Beleuchtung</li> <li>· Besonders geeignet zur Montage unter Hängeschränken oder an geraden Wand- und Möbelflächen</li> <li>· Einfaches Verlegen durch mitgelieferte Verbinder</li> </ul>			<ul style="list-style-type: none"> <li>· Idéal pour l'éclairage indirect</li> <li>· Idéal pour les meubles suspendus ou surfaces de meuble ou murs droits</li> <li>· Installation simple grâce aux connecteurs fournis</li> </ul>			<ul style="list-style-type: none"> <li>· Suitable for indirect lighting</li> <li>· Particularly suitable for mounting under cupboards or at straight walls or furniture</li> <li>· Simple mounting due to provided connectors</li> </ul>		
15	200				230	RGB	- <sup>1</sup>	4 x 400	1/BOX	4	10.000
<b>5 Fernbedienung</b> Télécommande Remote control <b>6 Endkappen</b> Embouts End caps <b>7 Steuereinheit mit IR-Empfänger</b> Unité de commande avec récepteur IR Repeater with IR-receiver			<ul style="list-style-type: none"> <li>· Geeignet zur indirekten farbigen Beleuchtung</li> <li>· Steuerung durch Fernbedienung mit Infrarotsensor</li> <li>· Besonders geeignet zur Montage unter Hängeschränken oder an geraden Wand- und Möbelflächen</li> <li>· Einfaches Verlegen durch mitgelieferte Verbinder</li> <li>· Fernbedienung inklusive CR 2025 Batterien sowie Halterung mit Befestigungsmaterial</li> </ul>			<ul style="list-style-type: none"> <li>· Idéal pour l'éclairage en couleur indirect</li> <li>· Contrôle par télécommande avec capteur infrarouge</li> <li>· Idéal pour les meubles suspendus ou surfaces de meuble ou murs droits</li> <li>· Installation simple grâce aux connecteurs fournis</li> <li>· Télécommande avec piles CR 2025, support et fixations incl.</li> </ul>			<ul style="list-style-type: none"> <li>· Suitable for indirect colorful lighting</li> <li>· Controlled by remote control with infrared sensor</li> <li>· Particularly suitable for mounting under cupboards or at straight walls or furniture</li> <li>· Simple mounting due to provided connectors</li> <li>· Remote control including CR 2025-batteries with holder and fixing accessories</li> </ul>		

<sup>1</sup> Dimmbar nur mit beiliegender Fernbedienung, nicht dimmbar über konventionelle Dimmer.

<sup>1</sup> Dimmable uniquement grâce à la télécommande ci-jointe, non dimmable par variateur conventionnel.

<sup>1</sup> Dimmable only with the accompanying remote control, not dimmable with conventional dimmers.

## LED Nightlight Sensor

	Typ	Code	EAN	Color	EEC kWh/1000h		W	lm	K
	Nightlight Sensor	27700001	4004894542260	white	-	54 x 54 x 59	0,5	2	2700
<div style="display: flex; justify-content: space-between; align-items: flex-start;"> <div style="text-align: center;"> <b>QUICK &amp; EASY</b></div> <div style="text-align: center;"> <b>DIRECT</b> Verbindung Connexion Connection</div> <div style="text-align: center;"> <b>Sensor</b> Capteur Sensor</div> <div style="text-align: center;"> nicht dimmbar non dimmable not dimmable</div> <div style="text-align: center;"> Schutzklasse II Classe de protection II Protection class II</div> <div style="text-align: center;"><b>220-230 V</b></div> <div style="text-align: center;"> nicht austauschbar non remplaçable not replaceable</div> </div> <p>Hinweise zur Energieeffizienzklasse auf Seite 92. / Les informations sur les catégories d'efficacité énergétique sont indiquées page 92. / Notes on Energy Efficiency Class on page 92.</p>									



## LED Nightlight Switch

	Typ	Code	EAN	Color	EEC kWh/1000h		W	lm	K
	Nightlight Switch	27700002	4004894542277	white	-	54 x 54 x 59	0,5	2	2700
<div style="display: flex; justify-content: space-between; align-items: flex-start;"> <div style="text-align: center;"> <b>QUICK &amp; EASY</b></div> <div style="text-align: center;"> <b>DIRECT</b> Verbindung Connexion Connection</div> <div style="text-align: center;"> <b>ON/OFF</b> <b>SWITCH</b></div> <div style="text-align: center;"> nicht dimmbar non dimmable not dimmable</div> <div style="text-align: center;"> Schutzklasse II Classe de protection II Protection class II</div> <div style="text-align: center;"><b>220-230 V</b></div> <div style="text-align: center;"> nicht austauschbar non remplaçable not replaceable</div> </div> <p>Hinweise zur Energieeffizienzklasse auf Seite 92. / Les informations sur les catégories d'efficacité énergétique sont indiquées page 92. / Notes on Energy Efficiency Class on page 92.</p>									

## LED Nightlight

	Typ	Code	EAN	Color	EEC kWh/1000h		W	lm	K
	Nightlight	27700003	4004894542284	white	-	54 x 54 x 59	0,5	2	2700
<div style="display: flex; justify-content: space-between; align-items: flex-start;"> <div style="text-align: center;"> <b>QUICK &amp; EASY</b></div> <div style="text-align: center;"> <b>DIRECT</b> Verbindung Connexion Connection</div> <div style="text-align: center;"> nicht dimmbar non dimmable not dimmable</div> <div style="text-align: center;"> Schutzklasse II Classe de protection II Protection class II</div> <div style="text-align: center;"><b>220-230 V</b></div> <div style="text-align: center;"> nicht austauschbar non remplaçable not replaceable</div> </div> <p>Hinweise zur Energieeffizienzklasse auf Seite 92. / Les informations sur les catégories d'efficacité énergétique sont indiquées page 92. / Notes on Energy Efficiency Class on page 92.</p>									

## LED Nightlight Amber Sensor

	Typ	Code	EAN	Color	EEC kWh/1000h		W	lm	K
	Nightlight Amber Sensor	400073	4018412326010	white	-	82 x 44 x 58	0,3	1	1500
<div style="display: flex; justify-content: space-between; align-items: flex-start;"> <div style="text-align: center;"> <b>QUICK &amp; EASY</b></div> <div style="text-align: center;"> <b>DIRECT</b> Verbindung Connexion Connection</div> <div style="text-align: center;"> <b>Sensor</b> Capteur Sensor</div> <div style="text-align: center;"> nicht dimmbar non dimmable not dimmable</div> <div style="text-align: center;"> Schutzklasse II Classe de protection II Protection class II</div> <div style="text-align: center;"><b>230 V</b></div> <div style="text-align: center;"> nicht austauschbar non remplaçable not replaceable</div> </div> <p>Hinweise zur Energieeffizienzklasse auf Seite 92. / Les informations sur les catégories d'efficacité énergétique sont indiquées page 92. / Notes on Energy Efficiency Class on page 92.</p>									

## LED Nightlight Amber Sensor

	Typ	Code	EAN	Color	EEC kWh/1000h		W	lm	K
	Nightlight Amber Sensor	400072	4018412325983	white	-	114 x 57 x 63	1,8	15	1500
<div style="display: flex; justify-content: space-between; align-items: flex-start;"> <div style="text-align: center;"> <b>QUICK &amp; EASY</b></div> <div style="text-align: center;"> <b>DIRECT</b> Verbindung Connexion Connection</div> <div style="text-align: center;"> <b>ON/OFF</b> <b>Sensor</b> Capteur Sensor</div> <div style="text-align: center;"> <b>Sensor</b> Capteur Sensor</div> <div style="text-align: center;"> nicht dimmbar non dimmable not dimmable</div> <div style="text-align: center;"> Schutzklasse II Classe de protection II Protection class II</div> <div style="text-align: center;"><b>220-230 V</b></div> <div style="text-align: center;"> nicht austauschbar non remplaçable not replaceable</div> </div> <p>Hinweise zur Energieeffizienzklasse auf Seite 92. / Les informations sur les catégories d'efficacité énergétique sont indiquées page 92. / Notes on Energy Efficiency Class on page 92.</p>									

# LED-STRIPS, NACHTLICHTER UND VIELES MEHR

BANDES LED, VEILLEUSES ET BIEN PLUS ENCORE / LED STRIPS, NIGHT LIGHTS AND MUCH MORE

## LED Nightlight Sensor

Typ	Code	EAN	Color	EEC kWh/1000h	W	lm	K	
Nightlight Sensor	27700009	4004894542345	white	-	112 x 112 x 36	1	5	2700

QUICK & EASY

Magnethalter  
Base magnétique  
Magnetic hold

Sensor  
Capteur  
Sensor

Sensor  
Capteur  
Sensor

integrierter Dimmer  
Gradateur intégré  
integrated dimmer

3x not incl.  
AAA Batterie  
Pile AAA  
AAA battery

Schutzklasse III  
Classe de protection III  
Protection class III

12 V

nicht austauschbar  
non remplaçable  
not replaceable

Hinweise zur Energieeffizienzklasse auf Seite 92. / Les informations sur les catégories d'efficacité énergétique sont indiquées page 92. / Notes on Energy Efficiency Class on page 92.

## LED Nightlight Sensor

Typ	Code	EAN	Color	EEC kWh/1000h	W	lm	K	
Nightlight Sensor	27700010	4004894542352	white	-	109 x 110 x 37	1	5	2700

QUICK & EASY

Magnethalter  
Base magnétique  
Magnetic hold

AUTO  
Abschaltung  
Interrupteur  
Switch off

Sensor  
Capteur  
Sensor

3x not incl.  
AAA Batterie  
Pile AAA  
AAA battery

Schutzklasse III  
Classe de protection III  
Protection class III

12 V

nicht austauschbar  
non remplaçable  
not replaceable

Hinweise zur Energieeffizienzklasse auf Seite 92. / Les informations sur les catégories d'efficacité énergétique sont indiquées page 92. / Notes on Energy Efficiency Class on page 92.

## LED Nightlight Pocket Sensor

Typ	Code	EAN	Color	EEC kWh/1000h	W	lm	K	
Nightlight Pocket Sensor	27700011	4004894542369	silver	-	164 x 44 x 68	1,6	1	3000

QUICK & EASY

DIRECT  
Verbindung  
Connexion  
Connection

Sensor  
Capteur  
Sensor

Notlichtfunktion  
Éclairage de secours  
Emergency lighting

AKKU  
Akkumulator  
Accumulateur  
Rechargeable battery

Schutzklasse II  
Classe de protection II  
Protection class II

Schutzklasse III  
Classe de protection III  
Protection class III

220-240 V

nicht austauschbar  
non remplaçable  
not replaceable

Hinweise zur Energieeffizienzklasse auf Seite 92. / Les informations sur les catégories d'efficacité énergétique sont indiquées page 92. / Notes on Energy Efficiency Class on page 92.

## LED Nightlight Pocket Sensor

Typ	Code	EAN	Color	EEC kWh/1000h	W	lm	K	
Nightlight Pocket Sensor	27700012	4004894542376	white	-	178 x 53 x 63	2	45/15	3000/ 6700

QUICK & EASY

DIRECT  
Verbindung  
Connexion  
Connection

Sensor  
Capteur  
Sensor

Notlichtfunktion  
Éclairage de secours  
Emergency lighting

AKKU  
Akkumulator  
Accumulateur  
Rechargeable battery

Schutzklasse II  
Classe de protection II  
Protection class II

Schutzklasse III  
Classe de protection III  
Protection class III

230 V

nicht austauschbar  
non remplaçable  
not replaceable

Hinweise zur Energieeffizienzklasse auf Seite 92. / Les informations sur les catégories d'efficacité énergétique sont indiquées page 92. / Notes on Energy Efficiency Class on page 92.

## LED Nightlight Pocket Sensor

Typ	Code	EAN	Color	EEC kWh/1000h	W	lm	K	
Nightlight Pocket Sensor	27700013	4004894542383	white	-	134 x 63 x 44	1,6	63/41	7000

QUICK & EASY

DIRECT  
Verbindung  
Connexion  
Connection

Sensor  
Capteur  
Sensor

AUTO  
Abschaltung  
Interrupteur  
Switch off

ON/OFF  
SWITCH

Notlichtfunktion  
Éclairage de secours  
Emergency lighting

AKKU  
Akkumulator  
Accumulateur  
Rechargeable battery

Schutzklasse II  
Classe de protection II  
Protection class II

230 V

Schutzklasse III  
Classe de protection III  
Protection class III

nicht austauschbar  
non remplaçable  
not replaceable

Hinweise zur Energieeffizienzklasse auf Seite 92. / Les informations sur les catégories d'efficacité énergétique sont indiquées page 92. / Notes on Energy Efficiency Class on page 92.

## LED Lightstick Switch Sensor



**NEW**

Typ	Code	EAN	Color	EEC kWh/1000h	mm	W	lm	K
Lightstick Switch Sensor	27700016	4004894850945	white	-	250 x 25 x 29	1	50	6000



**QUICK & EASY**



selbstklebend  
autocollant  
self-adhesive



ON/OFF  
**SWITCH**



ON/OFF  
Sensor  
Capteur  
Sensor



ON/OFF  
Sensor  
Capteur  
Sensor



3x  
incl.  
AA Batterie  
Pile AA  
AA battery



nicht dimmbar  
non dimmable  
not dimmable



Schutzklasse III  
Classe de protection III  
Protection class III

4,5 V



nicht austauschbar  
non remplaçable  
not replaceable

Hinweise zur Energieeffizienzklasse auf Seite 92. / Les informations sur les catégories d'efficacité énergétique sont indiquées page 92. / Notes on Energy Efficiency Class on page 92.

## LED Lightstick Sensor



Typ	Code	EAN	Color	EEC kWh/1000h	mm	W	lm	K
Lightstick Sensor	400083	4018412326294	silver	-	194 x 27 x 33	0,7	18	12500



**QUICK & EASY**



Magnethalter  
Base magnétique  
Magnetic hold



selbstklebend  
autocollant  
self-adhesive



ON/OFF  
Sensor  
Capteur  
Sensor

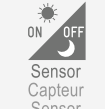

ON/OFF  
Sensor  
Capteur  
Sensor



3x  
incl.  
AAA Batterie  
Pile AAA  
AAA battery



nicht dimmbar  
non dimmable  
not dimmable



Schutzklasse III  
Classe de protection III  
Protection class III

4,5 V



nicht austauschbar  
non remplaçable  
not replaceable

Hinweise zur Energieeffizienzklasse auf Seite 92. / Les informations sur les catégories d'efficacité énergétique sont indiquées page 92. / Notes on Energy Efficiency Class on page 92.

## LED Lightstick DIM Sensor



Typ	Code	EAN	Color	EEC kWh/1000h	mm	W	lm	K
Lightstick DIM Sensor	400161	4018412329554	silver	-	267 x 90	1	50	4000



**QUICK & EASY**



selbstklebend  
autocollant  
self-adhesive



ON/OFF  
**SWITCH**



integrierter Dimmer  
Gradateur intégré  
integrated dimmer



4x  
incl.  
AAA Batterie  
Pile AAA  
AAA battery



Schutzklasse III  
Classe de protection III  
Protection class III

6 V



nicht austauschbar  
non remplaçable  
not replaceable



nicht austauschbar  
non remplaçable  
not replaceable

Hinweise zur Energieeffizienzklasse auf Seite 92. / Les informations sur les catégories d'efficacité énergétique sont indiquées page 92. / Notes on Energy Efficiency Class on page 92.

## LED Bedlight Sensor



**NEW**

Typ	Code	EAN	Color	EEC kWh/1000h	mm	W	lm	K
Bedlight Sensor	27700014	4004894850846	white	-	1000	1,1	85	4000



**QUICK & EASY**



selbstklebend  
autocollant  
self-adhesive



ON/OFF  
**SWITCH**



ON/OFF  
Sensor  
Capteur  
Sensor



ON/OFF  
Sensor  
Capteur  
Sensor



4x  
incl.  
AAA Batterie  
Pile AAA  
AAA battery



nicht dimmbar  
non dimmable  
not dimmable



Schutzklasse III  
Classe de protection III  
Protection class III

6 V



nicht austauschbar  
non remplaçable  
not replaceable

Hinweise zur Energieeffizienzklasse auf Seite 92. / Les informations sur les catégories d'efficacité énergétique sont indiquées page 92. / Notes on Energy Efficiency Class on page 92.

# LED-STRIPS, NACHTLICHTER UND VIELES MEHR

BANDES LED, VEILLEUSES ET BIEN PLUS ENCORE / LED STRIPS, NIGHT LIGHTS AND MUCH MORE

## LED Nightlight Sensor



Typ	Code	EAN	Color	EEC kWh/1000h	mm	W	lm	K
Nightlight Sensor	27700015	4004894850938	white	-	90 x 90 x 25	0,6	35	6000

- QUICK & EASY
- Magnethalter Base magnétique Magnetic hold
- ON/OFF SWITCH
- Sensor Capteur Sensor
- Sensor Capteur Sensor
- 3x incl. AA Batterie Pile AA AA battery
- nicht dimmbar non dimmable not dimmable
- Schutzklasse III Classe de protection III Protection class III
- 4,5 V
- nicht austauschbar non remplaçable not replaceable

Hinweise zur Energieeffizienzklasse auf Seite 92. / Les informations sur les catégories d'efficacité énergétique sont indiquées page 92. / Notes on Energy Efficiency Class on page 92.

## LED Drawer Light Sensor



Typ	Code	EAN	Color	EEC kWh/1000h	mm	W	lm	K
Drawer Light Sensor	400084	4018412326324	white	-	63 x 28 x 23	0,25	5	8000

- QUICK & EASY
- Magnethalter Base magnétique Magnetic hold
- Sensor Capteur Sensor
- 6x incl. LR44 Batterie Pile LR44 LR44 battery
- nicht dimmbar non dimmable not dimmable
- Schutzklasse III Classe de protection III Protection class III
- 4,5 V
- nicht austauschbar non remplaçable not replaceable

Hinweise zur Energieeffizienzklasse auf Seite 92. / Les informations sur les catégories d'efficacité énergétique sont indiquées page 92. / Notes on Energy Efficiency Class on page 92.

## LED Nightlight Flex Sensor



Typ	Code	EAN	Color	EEC kWh/1000h	mm	W	lm	K
Nightlight Flex Sensor	400080	4018412326201	black	-	97 x 86 x 35	0,3	9	12500

- QUICK & EASY
- Magnethalter Base magnétique Magnetic hold
- selbstklebend autocollant self-adhesive
- mit Aufhängebügel Crochet de suspension with holder
- Sensor Capteur Sensor
- Sensor Capteur Sensor
- 3x incl. AAA Batterie Pile AAA AAA battery
- nicht dimmbar non dimmable not dimmable
- Schutzklasse III Classe de protection III Protection class III
- 4,5 V
- nicht austauschbar non remplaçable not replaceable

Hinweise zur Energieeffizienzklasse auf Seite 92. / Les informations sur les catégories d'efficacité énergétique sont indiquées page 92. / Notes on Energy Efficiency Class on page 92.

## LED 3x Touchlight



Typ	Code	EAN	Color	EEC kWh/1000h	mm	W	lm	K
3x Touchlight	400136	4018412327727	silver	-	68 x 68 x 25	0,5	6	12500

- QUICK & EASY
- selbstklebend autocollant self-adhesive
- 9x incl. AAA Batterie Pile AAA AAA battery
- nicht dimmbar non dimmable not dimmable
- Schutzklasse III Classe de protection III Protection class III
- 4,5 V
- nicht austauschbar non remplaçable not replaceable

Hinweise zur Energieeffizienzklasse auf Seite 92. / Les informations sur les catégories d'efficacité énergétique sont indiquées page 92. / Notes on Energy Efficiency Class on page 92.

## LED Square Light Sensor



Typ	Code	EAN	Color	EEC kWh/1000h	mm	W	lm	K
Square Light Sensor	400081	4018412326232	white	-	92 x 92 x 25	0,5	12	12500

- QUICK & EASY
- Magnethalter Base magnétique Magnetic hold
- selbstklebend autocollant self-adhesive
- Sensor Capteur Sensor
- 4x incl. AAA Batterie Pile AAA AAA battery
- nicht dimmbar non dimmable not dimmable
- Schutzklasse III Classe de protection III Protection class III
- 6 V
- nicht austauschbar non remplaçable not replaceable

Hinweise zur Energieeffizienzklasse auf Seite 92. / Les informations sur les catégories d'efficacité énergétique sont indiquées page 92. / Notes on Energy Efficiency Class on page 92.

## LED Sensor Light

	Typ	Code	EAN	Color	EEC kWh/1000h				
	Sensor Light	400082	4018412326263	white	-	80 x 24	0,5	24	3000
<div style="display: flex; justify-content: space-between; align-items: flex-start;"> <div style="text-align: center;"> <b>QUICK &amp; EASY</b></div> <div style="text-align: center;"> selbstklebend autocollant self-adhesive</div> <div style="text-align: center;"> ON/OFF Sensor Capteur Sensor</div> <div style="text-align: center;"> 3x incl. AAA Batterie Pile AAA AAA battery</div> <div style="text-align: center;"> nicht dimmbar non dimmable not dimmable</div> <div style="text-align: center;"> Schutzklasse III Classe de protection III Protection class III</div> <div style="text-align: center;"><b>4,5 V</b></div> <div style="text-align: center;"> nicht austauschbar non remplaçable not replaceable</div> </div> <p>Hinweise zur Energieeffizienzklasse auf Seite 92. / Les informations sur les catégories d'efficacité énergétique sont indiquées page 92. / Notes on Energy Efficiency Class on page 92.</p>									

## LED Nightlight Amber Sensor

	Typ	Code	EAN	Color	EEC kWh/1000h				
	Nightlight Amber Sensor	27700017	4004894851218	white	-	66 x 66 x 51	0,4	2	1500
<div style="display: flex; justify-content: space-between; align-items: flex-start;"> <div style="text-align: center;"> <b>QUICK &amp; EASY</b></div> <div style="text-align: center;"> <b>DIRECT</b> Verbindung Connexion Connection</div> <div style="text-align: center;"> ON/OFF Sensor Capteur Sensor</div> <div style="text-align: center;"> nicht dimmbar non dimmable not dimmable</div> <div style="text-align: center;"> Schutzklasse II Classe de protection II Protection class II</div> <div style="text-align: center;"><b>220-240 V</b></div> <div style="text-align: center;"> nicht austauschbar non remplaçable not replaceable</div> </div> <p>Hinweise zur Energieeffizienzklasse auf Seite 92. / Les informations sur les catégories d'efficacité énergétique sont indiquées page 92. / Notes on Energy Efficiency Class on page 92.</p>									

## LED Nightlight Amber Sensor

	Typ	Code	EAN	Color	EEC kWh/1000h				
	Nightlight Amber Sensor	27700018	4004894851225	white	-	55 x 55 x 76	0,3	2	1500
<div style="display: flex; justify-content: space-between; align-items: flex-start;"> <div style="text-align: center;"> <b>QUICK &amp; EASY</b></div> <div style="text-align: center;"> <b>DIRECT</b> Verbindung Connexion Connection</div> <div style="text-align: center;"> ON/OFF Sensor Capteur Sensor</div> <div style="text-align: center;"> nicht dimmbar non dimmable not dimmable</div> <div style="text-align: center;"> Schutzklasse II Classe de protection II Protection class II</div> <div style="text-align: center;"><b>220-240 V</b></div> <div style="text-align: center;"> nicht austauschbar non remplaçable not replaceable</div> </div> <p>Hinweise zur Energieeffizienzklasse auf Seite 92. / Les informations sur les catégories d'efficacité énergétique sont indiquées page 92. / Notes on Energy Efficiency Class on page 92.</p>									

## LED Nightlight Amber USB Sensor

	Typ	Code	EAN	Color	EEC kWh/1000h				
	Nightlight Amber USB Sensor	27700019	4004894851232	white	-	86 x 86 x 58	0,4	5	1500
<div style="display: flex; justify-content: space-between; align-items: flex-start;"> <div style="text-align: center;"> <b>QUICK &amp; EASY</b></div> <div style="text-align: center;"> <b>DIRECT</b> Verbindung Connexion Connection</div> <div style="text-align: center;"> ON/OFF <b>SWITCH</b></div> <div style="text-align: center;"> ON/OFF Sensor Capteur Sensor</div> <div style="text-align: center;"> 2x 100 mA USB-Slot Port USB USB Port</div> <div style="text-align: center;"> nicht dimmbar non dimmable not dimmable</div> <div style="text-align: center;"> Schutzklasse II Classe de protection II Protection class II</div> <div style="text-align: center;"><b>220-240 V</b></div> <div style="text-align: center;"> nicht austauschbar non remplaçable not replaceable</div> </div> <p>Hinweise zur Energieeffizienzklasse auf Seite 92. / Les informations sur les catégories d'efficacité énergétique sont indiquées page 92. / Notes on Energy Efficiency Class on page 92.</p>									

## LED Nightlight Amber USB Sensor

	Typ	Code	EAN	Color	EEC kWh/1000h				
	Nightlight Amber USB Sensor	27700021	4004894851256	white	-	90 x 90 x 59	0,4	5	1500
<div style="display: flex; justify-content: space-between; align-items: flex-start;"> <div style="text-align: center;"> <b>QUICK &amp; EASY</b></div> <div style="text-align: center;"> <b>DIRECT</b> Verbindung Connexion Connection</div> <div style="text-align: center;"> ON/OFF <b>SWITCH</b></div> <div style="text-align: center;"> ON/OFF Sensor Capteur Sensor</div> <div style="text-align: center;"> 2x 100 mA USB-Slot Port USB USB Port</div> <div style="text-align: center;"> nicht dimmbar non dimmable not dimmable</div> <div style="text-align: center;"> Schutzklasse II Classe de protection II Protection class II</div> <div style="text-align: center;"><b>220-240 V</b></div> <div style="text-align: center;"> nicht austauschbar non remplaçable not replaceable</div> </div> <p>Hinweise zur Energieeffizienzklasse auf Seite 92. / Les informations sur les catégories d'efficacité énergétique sont indiquées page 92. / Notes on Energy Efficiency Class on page 92.</p>									

## LED-STRIPS, NACHTLICHTER UND VIELES MEHR

BANDES LED, VEILLEUSES ET BIEN PLUS ENCORE / LED STRIPS, NIGHT LIGHTS AND MUCH MORE

## LED Spotlight IP44 Sensor

NEW



Typ	Code	EAN	Color	EEC kWh/1000h		W	lm	K
Spotlight IP44 Sensor	27700022	4004894851317	brown	-	110 x 110 x 165	6	250	4000

IP 44

IP-Klasse  
Classe IP  
IP classON/OFF  
Sensor  
Capteur  
SensorON/OFF  
Sensor  
Capteur  
Sensor4x not incl.  
D Batterie  
Pile D  
D batterynicht dimmbar  
non dimmable  
not dimmableSchutzklasse III  
Classe de protection III  
Protection class III

6 V

nicht austauschbar  
non remplaçable  
not replaceable

Hinweise zur Energieeffizienzklasse auf Seite 92. / Les informations sur les catégories d'efficacité énergétique sont indiquées page 92. / Notes on Energy Efficiency Class on page 92.

## LED Nightlight Amber Sensor

NEW



Typ	Code	EAN	Color	EEC kWh/1000h		W	lm	K
Nightlight Amber Sensor	27700020	4004894851249	white	-	85 x 85 x 58	0,4	5	1500

QUICK &  
EASYDIRECT  
Verbindung  
Connexion  
ConnectionON/OFF  
SWITCHON/OFF  
Sensor  
Capteur  
SensorON/OFF  
Sensor  
Capteur  
Sensornicht dimmbar  
non dimmable  
not dimmableSchutzklasse II  
Classe de protection II  
Protection class II

220-240 V

nicht austauschbar  
non remplaçable  
not replaceable

Hinweise zur Energieeffizienzklasse auf Seite 92. / Les informations sur les catégories d'efficacité énergétique sont indiquées page 92. / Notes on Energy Efficiency Class on page 92.



MÜLLER  
LICHT



Unser Leuchtensortiment

# FÜR JEDEN WOHNBEREICH DIE RICHTIGE LEUCHE

Notre gamme de produits lumineux

TROUVER LE BON ECLAIRAGE POUR CHAQUE PIÈCE ET  
ESPACE DE VIE

Our luminaire assortment

THE RIGHT LUMINAIRE FOR EVERY LIVING AREA

## KELLER · WERKSTATT · AUSSENBEREICH

CAVE · ATELIER · EXTERIEUR

BASEMENT · WORKSHOP · OUTDOOR

56

## BÜRO · NEBENRAUM

BUREAU · ESPACE ANNEXE

OFFICE · SECONDARY ROOM

60

## UNIVERSAL

UNIVERSEL

UNIVERSAL

64

## KÜCHE · MÖBEL

CUISINE · MEUBLE

KITCHEN · FURNITURE

66

## BADEZIMMER

SALLE DE BAIN

BATHROOM

70

## EINBAUSPOTS

SPOTS ENCASTRES

BUILT-IN SPOTS

72

## PROMO

78

## HAPPY PRICE

80



## **BASISBELEUCHTUNG FÜR KELLER, WERKSTÄTTEN UND AUSSENBEREICHE**

MÜLLER-LICHT bietet eine Vielfalt an leicht zu montierenden Leuchten, die durch besonders große Lichtpakete bestehen. Je nach Typ ermöglichen integrierte Sensoren auch in Räumen wie Kellern oder Garagen größtmöglichen Lichtkomfort.

### **ECLAIRAGE DE BASE POUR LES CAVES, LES ATELIERS ET L'EXTERIEUR**

MÜLLER-LICHT offre une grande variété de lumières à installer qui se caractérisent par leurs performances élevées. En fonction du type de modèle, les capteurs intégrés vous permettront de profiter d'un confort lumineux optimal dans différentes pièces comme des caves ou des garages.

### **BASIC LIGHTING FOR BASEMENTS, WORKSHOPS AND OUTDOOR**

MÜLLER-LICHT offers a wide variety of easily installed luminaires with an impressively large light package. Depending on type, integrated sensors can also provide added comfort in rooms such as basements or garages.

LED Basic 1



Typ	Code	EAN	Color	EEC kWh/1000h	mm	W	lm	K
Basic 1 / 60	20300516	4004894849482	white	A / 15	600 x 60 x 61	15	1300	4000
Basic 1 / 90	20300517	4004894849499	white	A / 20	900 x 60 x 61	20	1750	4000
Basic 1 / 120	20300518	4004894849505	white	A / 30	1200 x 60 x 61	30	2700	4000
Basic 1 / 150	20300519	4004894849512	white	A / 35	1500 x 60 x 61	35	3100	4000



für Verbindung vorbereitet  
prêt à connecter  
for connection prepared



nicht dimmbar  
non dimmable  
not dimmable



Schutzklasse I  
Classe de protection I  
Protection class I

25.000 h  
220-240 V



nicht austauschbar  
non remplaçable  
not replaceable

**5** Jahre Garantie  
ans garantie  
years warranty  
[www.mueller-licht.de/garantie](http://www.mueller-licht.de/garantie)

Hinweise zur Energieeffizienzklasse auf Seite 92. / Les informations sur les catégories d'efficacité énergétique sont indiquées page 92. / Notes on Energy Efficiency Class on page 92.

LED Basic 2



Typ	Code	EAN	Color	EEC kWh/1000h	mm	W	lm	K
Basic 2 / 60	20300520	4004894849529	white	A / 30	600 x 75 x 51	30	2500	4000
Basic 2 / 90	20300521	4004894849536	white	A / 40	900 x 75 x 51	40	3400	4000
Basic 2 / 120	20300522	4004894849543	white	A / 60	1200 x 75 x 51	60	5000	4000
Basic 2 / 150	20300523	4004894849550	white	A / 70	1500 x 75 x 51	70	6100	4000



für Verbindung vorbereitet  
prêt à connecter  
for connection prepared



nicht dimmbar  
non dimmable  
not dimmable



Schutzklasse I  
Classe de protection I  
Protection class I

25.000 h  
220-240 V



nicht austauschbar  
non remplaçable  
not replaceable

**5** Jahre Garantie  
ans garantie  
years warranty  
[www.mueller-licht.de/garantie](http://www.mueller-licht.de/garantie)

Hinweise zur Energieeffizienzklasse auf Seite 92. / Les informations sur les catégories d'efficacité énergétique sont indiquées page 92. / Notes on Energy Efficiency Class on page 92.

LED Aquaround



Typ	Code	EAN	Color	EEC kWh/1000h	mm	W	lm	K
Aquaround	20300539	4004894851201	white	A / 20	350 x 125	20	1500	4000

**IP 65**

IP-Klasse  
Classe IP  
IP class



nicht dimmbar  
non dimmable  
not dimmable



Schutzklasse I  
Classe de protection I  
Protection class I

25.000 h  
220-240 V



nicht austauschbar  
non remplaçable  
not replaceable

**5** Jahre Garantie  
ans garantie  
years warranty  
[www.mueller-licht.de/garantie](http://www.mueller-licht.de/garantie)

Hinweise zur Energieeffizienzklasse auf Seite 92. / Les informations sur les catégories d'efficacité énergétique sont indiquées page 92. / Notes on Energy Efficiency Class on page 92.

LED Aquaslim



Typ	Code	EAN	Color	EEC kWh/1000h	mm	W	lm	K
Aquaslim 60	20300532	4004894850891	gray	A+ / 10	650 x 67 x 72	10	950	4000
Aquaslim 120	20300533	4004894850907	gray	A+ / 18	1260 x 67 x 72	18	1800	4000
Aquaslim 150	20300534	4004894850914	gray	A+ / 22	1560 x 67 x 72	22	2100	4000

**IP 65**

IP-Klasse  
Classe IP  
IP class



austauschbar  
remplaçable  
replaceable



incl. LED-Tube G13  
Tube LED G13  
LED tube G13



nicht dimmbar  
non dimmable  
not dimmable



Schutzklasse I  
Classe de protection I  
Protection class I

25.000 h  
220-240 V



> 100.000 x  
Schaltungen  
Cycles de commutation  
Switch cycles

Hinweise zur Energieeffizienzklasse auf Seite 92. / Les informations sur les catégories d'efficacité énergétique sont indiquées page 92. / Notes on Energy Efficiency Class on page 92.

Das passende Ersatz-Leuchtmittel finden Sie auf Seite 10. / Vous trouverez page 10 la bonne solution lumineuse. / Suitable replacement lamps please find on page 10.

## LED Bulkhead Oval

NEW		Typ	Code	EAN	Color	EEC kWh/1000h		W	lm	K
		Bulkhead Oval	20300535	4004894851164	white	A+ / 8	200 x 100 x 5	8	550	4000

**IP 54**  
IP-Klasse  
Classe IP  
IP class

  
nicht dimmbar  
non dimmable  
not dimmable

  
Schutzklasse II  
Classe de protection II  
Protection class II

25.000 h  
100-240 V

  
nicht austauschbar  
non remplaçable  
not replaceable

**5 Jahre Garantie**  
ans garantie  
years warranty  
[www.mueller-licht.de/garantie](http://www.mueller-licht.de/garantie)

Hinweise zur Energieeffizienzklasse auf Seite 92. / Les informations sur les catégories d'efficacité énergétique sont indiquées page 92. / Notes on Energy Efficiency Class on page 92.

## LED Bulkhead Oval Sensor

NEW		Typ	Code	EAN	Color	EEC kWh/1000h		W	lm	K
		Bulkhead Oval Sensor	20300536	4004894851171	white	A+ / 8	200 x 100 x 5	8	550	4000

**IP 54**  
IP-Klasse  
Classe IP  
IP class

  
Sensor  
Capteur  
Sensor

  
Sensor  
Capteur  
Sensor

  
nicht dimmbar  
non dimmable  
not dimmable

  
Schutzklasse II  
Classe de protection II  
Protection class II

25.000 h  
100-240 V

  
nicht austauschbar  
non remplaçable  
not replaceable

**5 Jahre Garantie**  
ans garantie  
years warranty  
[www.mueller-licht.de/garantie](http://www.mueller-licht.de/garantie)

Hinweise zur Energieeffizienzklasse auf Seite 92. / Les informations sur les catégories d'efficacité énergétique sont indiquées page 92. / Notes on Energy Efficiency Class on page 92.

## LED Bulkhead Round

NEW		Typ	Code	EAN	Color	EEC kWh/1000h		W	lm	K
		Bulkhead Round	20300537	4004894851188	white	A+ / 8	176 x 56	8	550	4000

**IP 54**  
IP-Klasse  
Classe IP  
IP class

  
nicht dimmbar  
non dimmable  
not dimmable

  
Schutzklasse II  
Classe de protection II  
Protection class II

25.000 h  
100-240 V

  
nicht austauschbar  
non remplaçable  
not replaceable

**5 Jahre Garantie**  
ans garantie  
years warranty  
[www.mueller-licht.de/garantie](http://www.mueller-licht.de/garantie)

Hinweise zur Energieeffizienzklasse auf Seite 92. / Les informations sur les catégories d'efficacité énergétique sont indiquées page 92. / Notes on Energy Efficiency Class on page 92.

## LED Bulkhead Round Sensor

NEW		Typ	Code	EAN	Color	EEC kWh/1000h		W	lm	K
		Bulkhead Round Sensor	20300538	4004894851195	white	A+ / 8	176 x 56	8	550	4000

**IP 54**  
IP-Klasse  
Classe IP  
IP class

  
Sensor  
Capteur  
Sensor

  
Sensor  
Capteur  
Sensor

  
nicht dimmbar  
non dimmable  
not dimmable

  
Schutzklasse II  
Classe de protection II  
Protection class II

25.000 h  
100-240 V

  
nicht austauschbar  
non remplaçable  
not replaceable

**5 Jahre Garantie**  
ans garantie  
years warranty  
[www.mueller-licht.de/garantie](http://www.mueller-licht.de/garantie)

Hinweise zur Energieeffizienzklasse auf Seite 92. / Les informations sur les catégories d'efficacité énergétique sont indiquées page 92. / Notes on Energy Efficiency Class on page 92.

LED Aqualux



Typ	Code	EAN	Color	EEC kWh/1000h		W	lm	K
Aqualux 60	20300527	4004894850785	gray	A+ / 14	600 x 76 x 67	14	1320	4000
Aqualux 120	20300528	4004894850792	gray	A+ / 28	1200 x 76 x 67	28	2750	4000
Aqualux 150	20300529	4004894850808	gray	A+ / 35	1500 x 76 x 67	35	3300	4000

**IP 65**

IP-Klasse  
Classe IP  
IP class



nicht dimmbar  
non dimmable  
not dimmable



Schutzklasse I  
Classe de protection I  
Protection class I

25.000 h  
220-240 V



nicht austauschbar  
non remplaçable  
not replaceable

**5 Jahre Garantie**  
ans garantie  
years warranty  
[www.mueller-licht.de/garantie](http://www.mueller-licht.de/garantie)

Hinweise zur Energieeffizienzklasse auf Seite 92. / Les informations sur les catégories d'efficacité énergétique sont indiquées page 92. / Notes on Energy Efficiency Class on page 92.

LED Aqualux Sensor



Typ	Code	EAN	Color	EEC kWh/1000h		W	lm	K
Aqualux Sensor 120	20300530	4004894850815	gray	A+ / 28	1200 x 76 x 67	28	2750	4000
Aqualux Sensor 150	20300531	4004894850822	gray	A+ / 35	1500 x 76 x 67	35	3300	4000

**IP 65**

IP-Klasse  
Classe IP  
IP class



ON/OFF  
Sensor  
Capteur  
Sensor



ON/OFF  
Sensor  
Capteur  
Sensor



nicht dimmbar  
non dimmable  
not dimmable



Schutzklasse I  
Classe de protection I  
Protection class I

25.000 h  
220-240 V



nicht austauschbar  
non remplaçable  
not replaceable

**5 Jahre Garantie**  
ans garantie  
years warranty  
[www.mueller-licht.de/garantie](http://www.mueller-licht.de/garantie)

Hinweise zur Energieeffizienzklasse auf Seite 92. / Les informations sur les catégories d'efficacité énergétique sont indiquées page 92. / Notes on Energy Efficiency Class on page 92.



## FUNKTIONELLE BELEUCHTUNG FÜR DAS HEIMISCHE BÜRO

Egal ob im Homeoffice oder Nebenraum: MÜLLER-LICHT bietet ein innovatives Sortiment an qualitativ hochwertigen Leuchten, die je nach Typ durch integrierte Sensorik oder Dimmbarkeit für höchsten Komfort sorgen. Zudem ermöglichen verschiedene Lichtfarben den Einsatz des richtigen Produktes für jede Anwendung.

### ECLAIRAGE PRATIQUE POUR LE BUREAU A LA MAISON

Que vous travaillez de chez vous ou qu'il s'agisse d'une pièce annexe: MÜLLER-LICHT propose toute une gamme innovante d'éclairages de qualité, qui assurent avec leurs capteurs ou solution de réglage intégrés, un niveau de confort optimal. Les différentes couleurs permettent également d'utiliser le bon produit pour chaque application.

### FUNCTIONAL LIGHTING FOR THE HOME OFFICE

Whether for home office or a secondary room: MÜLLER-LICHT offers an innovative assortment of high-quality luminaires that provide the highest level of comfort with integrated sensors and dimming, depending on type. Various light colors also ensure that the right product is available for every application.

LED Office Prisma



NEW

Typ	Code	EAN	Color	EEC kWh/1000h		W	lm	K
Office Prisma 60	20300524	4004894849925	white	A+ / 10	627 x 164 x 59	10	950	4000
Office Prisma 120	20300525	4004894849932	white	A+ / 18	1237 x 164 x 59	18	1800	4000
Office Prisma 150	20300526	4004894849949	white	A+ / 22	1537 x 164 x 59	22	2100	4000

austauschbar  
remplaçable  
replaceable  
 incl. 2x  
LED-Tube G13  
Tube LED G13  
LED tube G13  
 nicht dimmbar  
non dimmable  
not dimmable  
 Schutzklasse I  
Classe de protection I  
Protection class I  
 25.000 h  
220-240 V  
 > 100.000 x  
Schaltungen  
Cycles de commutation  
Switch cycles

Hinweise zur Energieeffizienzklasse auf Seite 92. / Les informations sur les catégories d'efficacité énergétique sont indiquées page 92. / Notes on Energy Efficiency Class on page 92.

Das passende Ersatz-Leuchtmittel finden Sie auf Seite 10. / Vous trouverez page 10 la bonne solution lumineuse. / Suitable replacement lamps please find on page 10.

LED Office DIM Flat



NEW

Typ	Code	EAN	Color	EEC kWh/1000h		W	lm	K
Office DIM Flat 60	20500068	4004894850969	white	A+ / 25	613 x 120 x 33	25	2300	4000
Office DIM Flat 60	20500072	4004894850003	white	A+ / 25	613 x 120 x 33	25	2350	6500
Office DIM Flat 90	20500069	4004894850976	white	A+ / 35	913 x 120 x 33	35	3400	4000
Office DIM Flat 120	20500070	4004894850983	white	A+ / 45	1213 x 120 x 33	45	4900	4000
Office DIM Flat 120	20500073	4004894851010	white	A+ / 45	1213 x 120 x 33	45	5000	6500
Office DIM Flat 150	20500071	4004894850990	white	A+ / 45	1513 x 120 x 33	45	4800	4000

dimmbar  
dimmable  
dimmable  
 25.000 h  
220-240 V  
 Schutzklasse I  
Classe de protection I  
Protection class I  
 nicht austauschbar  
non remplaçable  
not replaceable  
**5 Jahre Garantie**  
ans garantie  
years warranty  
www.mueller-licht.de/garantie

Hinweise zur Energieeffizienzklasse auf Seite 92. / Les informations sur les catégories d'efficacité énergétique sont indiquées page 92. / Notes on Energy Efficiency Class on page 92.

LED Office DIM Softlux



NEW

Typ	Code	EAN	Color	EEC kWh/1000h		W	lm	K
Office DIM Softlux 60	20500074	4004894851027	white	A+ / 23	603 x 164 x 48	23	2200	4000
Office DIM Softlux 60	20500077	4004894851058	white	A+ / 23	603 x 164 x 48	23	2300	6500
Office DIM Softlux 90	20500075	4004894851034	white	A+ / 33	903 x 164 x 48	33	3200	4000
Office DIM Softlux 120	20500076	4004894851041	white	A+ / 47	1203 x 164 x 48	47	4500	4000
Office DIM Softlux 120	20500078	4004894851065	white	A+ / 47	1203 x 164 x 48	47	4600	6500

dimmbar  
dimmable  
dimmable  
 Schutzklasse I  
Classe de protection I  
Protection class I  
 25.000 h  
220-240 V  
 nicht austauschbar  
non remplaçable  
not replaceable  
**5 Jahre Garantie**  
ans garantie  
years warranty  
www.mueller-licht.de/garantie

Hinweise zur Energieeffizienzklasse auf Seite 92. / Les informations sur les catégories d'efficacité énergétique sont indiquées page 92. / Notes on Energy Efficiency Class on page 92.

## LED Office DIM



NEW

Typ	Code	EAN	Color	EEC kWh/1000h	mm	W	lm	K
Office DIM 60	20500079	4004894851072	white	B / 23	593 x 185 x 50	23	1200	4000
Office DIM 60	20500082	4004894851102	white	B / 23	593 x 185 x 50	23	1250	6500
Office DIM 90	20500080	4004894851089	white	A / 33	893 x 185 x 50	33	2200	4000
Office DIM 120	20500081	4004894851096	white	A / 45	1193 x 185 x 50	45	2800	4000
Office DIM 120	20500083	4004894851119	white	A / 45	1193 x 185 x 50	45	2900	6500

- dimmbar  
dimnable  
dimmable
- Schutzklasse I  
Classe de protection I  
Protection class I
- 25.000 h  
220-240 V
- nicht austauschbar  
non remplaçable  
not replaceable
- 5 Jahre Garantie**  
ans garantie  
years warranty  
[www.mueller-licht.de/garantie](http://www.mueller-licht.de/garantie)

Hinweise zur Energieeffizienzklasse auf Seite 92. / Les informations sur les catégories d'efficacité énergétique sont indiquées page 92. / Notes on Energy Efficiency Class on page 92.

## LED Office Square



NEW

Typ	Code	EAN	Color	EEC kWh/1000h	mm	W	lm	K
Office Square	20500084	4004894851126	white	A / 25	280 x 280 x 51	25	1600	3000

- QUICK & EASY
- einfache Installation  
Installation facile  
easy installation
- IP 44  
IP-Klasse  
Classe IP  
IP class
- nicht dimmbar  
non dimmable  
not dimmable
- Schutzklasse II  
Classe de protection II  
Protection class II
- 25.000 h  
100-240 V
- nicht austauschbar  
non remplaçable  
not replaceable

**5 Jahre Garantie**  
ans garantie  
years warranty  
[www.mueller-licht.de/garantie](http://www.mueller-licht.de/garantie)

Hinweise zur Energieeffizienzklasse auf Seite 92. / Les informations sur les catégories d'efficacité énergétique sont indiquées page 92. / Notes on Energy Efficiency Class on page 92.

## LED Office Square Sensor



NEW

Typ	Code	EAN	Color	EEC kWh/1000h	mm	W	lm	K
Office Square Sensor	20500085	4004894851133	white	A / 25	280 x 280 x 51	25	1600	3000

- QUICK & EASY
- einfache Installation  
Installation facile  
easy installation
- IP 44  
IP-Klasse  
Classe IP  
IP class
- ON/OFF  
Sensor  
Capteur  
Sensor
- ON/OFF  
Sensor  
Capteur  
Sensor
- nicht dimmbar  
non dimmable  
not dimmable
- Schutzklasse II  
Classe de protection II  
Protection class II
- 25.000 h  
100-240 V
- nicht austauschbar  
non remplaçable  
not replaceable

**5 Jahre Garantie**  
ans garantie  
years warranty  
[www.mueller-licht.de/garantie](http://www.mueller-licht.de/garantie)

Hinweise zur Energieeffizienzklasse auf Seite 92. / Les informations sur les catégories d'efficacité énergétique sont indiquées page 92. / Notes on Energy Efficiency Class on page 92.

LED Office Round



**NEW**

Typ	Code	EAN	Color	EEC kWh/1000h				
Office Round	20500086	4004894851140	white	A / 24	280 x 53	24	1600	3000

  
**QUICK & EASY**

  
 einfache Installation  
 Installation facile  
 easy installation

**IP 44**  
 IP-Klasse  
 Classe IP  
 IP class

  
 nicht dimmbar  
 non dimmable  
 not dimmable

  
 Schutzklasse II  
 Classe de protection II  
 Protection class II

**25.000 h**  
**100-240 V**

  
 nicht austauschbar  
 non remplaçable  
 not replaceable

**5 Jahre Garantie**  
**ans garantie**  
**years warranty**  
[www.mueller-licht.de/garantie](http://www.mueller-licht.de/garantie)

Hinweise zur Energieeffizienzklasse auf Seite 92. / Les informations sur les catégories d'efficacité énergétique sont indiquées page 92. / Notes on Energy Efficiency Class on page 92.

LED Office Round Sensor



**NEW**

Typ	Code	EAN	Color	EEC kWh/1000h				
Office Round Sensor	20500087	4004894851157	white	A / 24	280 x 53	24	1600	3000

  
**QUICK & EASY**

  
 einfache Installation  
 Installation facile  
 easy installation

**IP 44**  
 IP-Klasse  
 Classe IP  
 IP class

  
 ON/OFF  
 Sensor  
 Capteur  
 Sensor

  
 ON OFF  
 Sensor  
 Capteur  
 Sensor

  
 nicht dimmbar  
 non dimmable  
 not dimmable

  
 Schutzklasse II  
 Classe de protection II  
 Protection class II

**25.000 h**  
**100-240 V**

  
 nicht austauschbar  
 non remplaçable  
 not replaceable

**5 Jahre Garantie**  
**ans garantie**  
**years warranty**  
[www.mueller-licht.de/garantie](http://www.mueller-licht.de/garantie)

Hinweise zur Energieeffizienzklasse auf Seite 92. / Les informations sur les catégories d'efficacité énergétique sont indiquées page 92. / Notes on Energy Efficiency Class on page 92.



## UNIVERSALBELEUCHTUNG RUND UM DAS ZUHAUSE

Die Universalleuchten von MÜLLER-LICHT sind in verschiedenen Wohnbereichen vielfältig einsetzbar. Neben der hervorragenden Lichtqualität überzeugen sie zudem durch ihr flaches Design und eine besonders einfache Montage.

### ECLAIRAGE UNIVERSEL DANS TOUTE LA MAISON

Les modèles de lampes universelles de MÜLLER-LICHT peuvent être installés dans différentes espaces de la maison. En marge de leur excellente qualité lumineuse, ils présentent un design épuré et sont très faciles à monter.

### UNIVERSAL LIGHTING FOR HOME

The universal luminaires from MÜLLER-LICHT are extremely versatile and suitable for use in a variety of living areas. In addition to the outstanding light quality, they are distinguished by a modern flat design and especially easy installation.

## LED Lightbar Switch



Typ	Code	EAN	Color	EEC kWh/1000h		W	lm	K
Lightbar Switch 30	20100301	4004894534982	white	A+ / 4	310 x 35 x 56	4	270	3000
Lightbar Switch 50	20100302	4004894534999	white	A+ / 6	513 x 35 x 56	6	480	3000

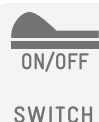

Hinweise zur Energieeffizienzklasse auf Seite 92. / Les informations sur les catégories d'efficacité énergétique sont indiquées page 92. / Notes on Energy Efficiency Class on page 92.

Das passende Ersatz-Leuchtmittel finden Sie auf Seite 12. / Vous trouverez page 12 la bonne solution lumineuse. / Suitable replacement lamps please find on page 12.

LED Lightbar Connect



Typ	Code	EAN	Color	EEC kWh/1000h		W	lm	K
Lightbar Connect 30	20100292	4004894520817	white	A+ / 5	279 x 28 x 36	4,5	400	4000
Lightbar Connect 30	20100288	4004894520770	white	A+ / 5	279 x 28 x 36	5	360	3000
Lightbar Connect 55	20100289	4004894520787	white	A+ / 8	507 x 28 x 36	7,5	700	3000
Lightbar Connect 55	20100293	4004894520824	white	A+ / 8	507 x 28 x 36	7,5	700	4000
Lightbar Connect 85	20100290	4004894520794	white	A+ / 14	840 x 28 x 36	14	1300	3000
Lightbar Connect 85	20100294	4004894520831	white	A+ / 14	840 x 28 x 36	14	1400	4100
Lightbar Connect 120	20100291	4004894520800	white	A+ / 20	1140 x 28 x 36	20	1700	3000
Lightbar Connect 120	20100295	4004894520848	white	A+ / 20	1140 x 28 x 36	20	1900	4000
Lightbar Connect 150	20100309	4004894849314	white	A+ / 23	1440 x 28 x 36	23	2200	3000
Lightbar Connect 150	20100310	4004894849321	white	A+ / 23	1440 x 28 x 36	23	2300	4000

**QUICK & EASY**  
 incl. 180 cm  
 Zuleitung  
 Cable électrique  
 Electric cable  
 koppelbar  
 connectable  
 connectable  
**ON/OFF**  
**SWITCH**  
 nicht dimmbar  
 non dimmable  
 not dimmable  
 Schutzklasse II  
 Classe de protection II  
 Protection class II  
 25.000 h  
 220-240 V  
 nicht austauschbar  
 non remplaçable  
 not replaceable

**5 Jahre Garantie**  
 ans garantie  
 years warranty  
[www.mueller-licht.de/garantie](http://www.mueller-licht.de/garantie)

Hinweise zur Energieeffizienzklasse auf Seite 92. / Les informations sur les catégories d'efficacité énergétique sont indiquées page 92. / Notes on Energy Efficiency Class on page 92.

LED Ceiling Light Switch



Typ	Code	EAN	Color	EEC kWh/1000h		W	lm	K
Ceiling Light Switch 45	20300395	4004894533282	white	A++ / 4	426 x 32 x 40	4	380	4000
Ceiling Light Switch 70	20300396	4004894533299	white	A+ / 7	656 x 32 x 40	7	700	4000
Ceiling Light Switch 100	20300397	4004894533305	white	A+ / 11	988 x 32 x 40	11	1100	4000
Ceiling Light Switch 130	20300398	4004894533312	white	A+ / 14	1288 x 32 x 40	14	1400	4000
Ceiling Light Switch 160	20300399	4004894535781	white	A+ / 19	1591 x 32 x 40	19	1900	4000

**ON/OFF**  
**SWITCH**  
 nicht dimmbar  
 non dimmable  
 not dimmable  
 Schutzklasse II  
 Classe de protection II  
 Protection class II  
 25.000 h  
 220-240 V  
 nicht austauschbar  
 non remplaçable  
 not replaceable  
**5 Jahre Garantie**  
 ans garantie  
 years warranty  
[www.mueller-licht.de/garantie](http://www.mueller-licht.de/garantie)

Hinweise zur Energieeffizienzklasse auf Seite 92. / Les informations sur les catégories d'efficacité énergétique sont indiquées page 92. / Notes on Energy Efficiency Class on page 92.

LT Softlux



Typ	Code	EAN	Color	EEC kWh/1000h		W	lm	K
Softlux 40	20300400	4004894418565	white	A	385 x 32 x 60	8	420	4000
Softlux 70	20300401	4004894494552	white	A+	645 x 32 x 60	14	1200	4000
Softlux 100	20300402	4004894418589	white	A+	945 x 32 x 60	21	1890	4000
Softlux 130	20300403	4004894418596	white	A+	1245 x 32 x 60	28	2600	4000
Softlux 160	20300404	4004894418602	white	A+	1545 x 32 x 60	35	3320	4000

**IP 40**  
 IP-Klasse  
 Classe IP  
 IP class  
**ON/OFF**  
**SWITCH**  
 incl. Tube G5  
 Tube G5  
 Tube G5  
 austauschbar  
 remplaçable  
 replaceable  
 nicht dimmbar  
 non dimmable  
 not dimmable  
 15.000 h  
 220-240 V  
 > 10.000 x  
 Schaltungen  
 Cycles de commutation  
 Switch cycles  
 Schutzklasse I  
 Classe de protection I  
 Protection class I

Hinweise zur Energieeffizienzklasse auf Seite 92. / Les informations sur les catégories d'efficacité énergétique sont indiquées page 92. / Notes on Energy Efficiency Class on page 92.

Das passende Ersatz-Leuchtmittel finden Sie auf Seite 28 / Vous trouverez page 28 la bonne solution lumineuse. / Suitable replacement lamps please find on page 28.



## KREATIVE BELEUCHTUNGS- IDEEN FÜR KÜCHE UND MÖBEL

MÜLLER-LICHT bietet Ihnen und Ihren Kunden ein breites Sortiment an qualitativ hochwertigen Leuchten, die bei bester Lichtqualität je nach Typ durch ihr flaches Design und integrierte Sensorik überzeugen.

### DES IDEES D'INSTALLATIONS LUMINEUSES CREATIVES POUR LA CUISINE ET LES MEUBLES

MÜLLER-LICHT vous propose, à vous et vos clients, une vaste gamme de lumières de qualité, qui en plus d'être performantes, présentent un style épuré et disposent de capteurs intégrés.

### CREATIVE LIGHTING IDEAS FOR KITCHEN AND FURNITURE

MÜLLER-LICHT offers you and your customers a wide assortment of high-quality luminaires that provide the best light quality with their flat design and integrated sensors, depending on the type.

LED Cabinet Light Sensor



Typ	Code	EAN	Color	EEC kWh/1000h		W	lm	K
Cabinet Light Sensor 60	20000047	4004894533213	white	A / 6	550 x70 x 25	6	450	3000
Cabinet Light Sensor 60	20000048	4004894533220	titan	A / 6	550 x70 x 25	6	450	3000
Cabinet Light Sensor 90	20000049	4004894533237	white	A / 9	820 x70 x 25	9	700	3000
Cabinet Light Sensor 90	20000050	4004894533244	titan	A / 9	820 x70 x 25	9	700	3000

**QUICK & EASY**  
 incl. 180 cm  
Zuleitung  
Cable électrique  
Electric cable  
 koppelbar  
connectable  
connectable  
 ON/OFF  
IR Sensor  
Capteur infrarouge  
infrared sensor  
 nicht dimmbar  
non dimmable  
not dimmable  
 Schutzklasse II  
Classe de protection II  
Protection class II  
 25.000 h  
220-240 V  
 nicht austauschbar  
non remplaçable  
not replaceable

**5 Jahre Garantie**  
ans garantie  
years warranty  
[www.mueller-licht.de/garantie](http://www.mueller-licht.de/garantie)

Hinweise zur Energieeffizienzklasse auf Seite 92. / Les informations sur les catégories d'efficacité énergétique sont indiquées page 92. / Notes on Energy Efficiency Class on page 92.

LED Cabinet Light DIM



Typ	Code	EAN	Color	EEC kWh/1000h		W	lm	K
Cabinet Light DIM 40	20000066	4004894849345	white	A+ / 7	424 x 53 x 29	7	460	4000
Cabinet Light DIM 40	20000069	4004894849376	silver	A+ / 7	424 x 53 x 29	7	460	4000
Cabinet Light DIM 60	20000067	4004894849352	white	A+ / 9	609 x 53 x 29	9	700	4000
Cabinet Light DIM 60	20000070	4004894849383	silver	A+ / 9	609 x 53 x 29	9	700	4000
Cabinet Light DIM 90	20000068	4004894849369	white	A / 15	909 x 53 x 29	15	1100	4000
Cabinet Light DIM 90	20000071	4004894849390	silver	A / 15	909 x 53 x 29	15	1100	4000

**QUICK & EASY**  
 incl. 180 cm  
Zuleitung  
Cable électrique  
Electric cable  
 koppelbar  
connectable  
connectable  
 ON/OFF  
SWITCH  
 integrierter Dimmer  
Gradateur intégré  
integrated dimmer  
 Schutzklasse II  
Classe de protection II  
Protection class II  
 25.000 h  
220-240 V  
 nicht austauschbar  
non remplaçable  
not replaceable

**5 Jahre Garantie**  
ans garantie  
years warranty  
[www.mueller-licht.de/garantie](http://www.mueller-licht.de/garantie)

Hinweise zur Energieeffizienzklasse auf Seite 92. / Les informations sur les catégories d'efficacité énergétique sont indiquées page 92. / Notes on Energy Efficiency Class on page 92.

LED Cabinet Light Sensor



Typ	Code	EAN	Color	EEC kWh/1000h		W	lm	K
Cabinet Light Sensor 30	20100305	4004894539314	white	A / 5	325 x 25 x 15	5	210	3000
Cabinet Light Sensor 50	20100306	4004894539321	white	A / 9	525 x 25 x 15	8,5	420	3000

**QUICK & EASY**  
 incl. 140 cm  
Zuleitung  
Cable électrique  
Electric cable  
 ON/OFF  
IR Sensor  
Capteur infrarouge  
infrared sensor  
 nicht dimmbar  
non dimmable  
not dimmable  
 Schutzklasse II  
Classe de protection II  
Protection class II  
 25.000 h  
230 V  
 nicht austauschbar  
non remplaçable  
not replaceable

**5 Jahre Garantie**  
ans garantie  
years warranty  
[www.mueller-licht.de/garantie](http://www.mueller-licht.de/garantie)

Hinweise zur Energieeffizienzklasse auf Seite 92. / Les informations sur les catégories d'efficacité énergétique sont indiquées page 92. / Notes on Energy Efficiency Class on page 92.

## LED Cabinet Light Touch-DIM

Typ	Code	EAN	Color	EEC kWh/1000h	mm	W	lm	K
Cabinet Light Touch-DIM 30	20100307	4004894539338	white	A / 5	320 x 25 x 15	5	210	3000
Cabinet Light Touch-DIM 50	20100308	4004894539345	white	A / 9	520 x 25 x 15	8,5	420	3000



**QUICK & EASY**



incl. 140 cm  
Zuleitung  
Cable électrique  
Electric cable



integrierter Dimmer  
Gradateur intégré  
integrated dimmer



Schutzklasse II  
Classe de protection II  
Protection class II

25.000 h  
230 V



nicht austauschbar  
non remplaçable  
not replaceable

**5 Jahre Garantie**  
ans garantie  
years warranty  
[www.mueller-licht.de/garantie](http://www.mueller-licht.de/garantie)

Hinweise zur Energieeffizienzklasse auf Seite 92. / Les informations sur les catégories d'efficacité énergétique sont indiquées page 92. / Notes on Energy Efficiency Class on page 92.

## LT Rondine

Typ	Code	EAN	Color	EEC kWh/1000h	mm	W	lm	K
Rondine	20300002	4004894110308	white	A / 48	409 x 470	40	3200	4000



incl.  
Ringröhre  
Tube annulaire  
Circular tube



austauschbar  
remplaçable  
replaceable



nicht dimmbar  
non dimmable  
not dimmable



Schutzklasse I  
Classe de protection I  
Protection class I

10.000 h  
230 V



> 10.000 x  
Schaltungen  
Cycles de commutation  
Switch cycles

Hinweise zur Energieeffizienzklasse auf Seite 92. / Les informations sur les catégories d'efficacité énergétique sont indiquées page 92. / Notes on Energy Efficiency Class on page 92.

## LED Cabinet Light Swing Sensor

Typ	Code	EAN	Color	EEC kWh/1000h	mm	W	lm	K
Cabinet Light Swing Sensor 60	20000078	4004894850839	titan	A / 10	559 x 61 x 30	10	580	3000
Cabinet Light Swing Sensor 60	20000083	4004894851331	white	A / 10	559 x 61 x 30	10	580	3000



**QUICK & EASY**



incl. 180 cm  
Zuleitung  
Cable électrique  
Electric cable



koppelbar  
connectable  
connectable



IR Sensor  
Capteur infrarouge  
infrared sensor



ON/OFF  
schwenkbar  
pivotant  
swiveling



nicht dimmbar  
non dimmable  
not dimmable



Schutzklasse II  
Classe de protection II  
Protection class II

25.000 h  
220-240 V



nicht austauschbar  
non remplaçable  
not replaceable

**5 Jahre Garantie**  
ans garantie  
years warranty  
[www.mueller-licht.de/garantie](http://www.mueller-licht.de/garantie)

Hinweise zur Energieeffizienzklasse auf Seite 92. / Les informations sur les catégories d'efficacité énergétique sont indiquées page 92. / Notes on Energy Efficiency Class on page 92.

## LED Movespot Sensor

Typ	Code	EAN	Color	EEC kWh/1000h	mm	W	lm	K
Movespot Sensor 60	20000082	4004894850952	titan	A / 6	560 x 46 x 25	5,4	160	3000



**QUICK & EASY**



incl. 180 cm  
Zuleitung  
Cable électrique  
Electric cable



koppelbar  
connectable  
connectable



ON/OFF  
IR Sensor  
Capteur infrarouge  
infrared sensor



einzeln verschiebbar  
ajustable seul  
individual shiftable



nicht dimmbar  
non dimmable  
not dimmable



Schutzklasse II  
Classe de protection II  
Protection class II

25.000 h  
220-240 V



nicht austauschbar  
non remplaçable  
not replaceable

**5 Jahre Garantie**  
ans garantie  
years warranty  
[www.mueller-licht.de/garantie](http://www.mueller-licht.de/garantie)

Hinweise zur Energieeffizienzklasse auf Seite 92. / Les informations sur les catégories d'efficacité énergétique sont indiquées page 92. / Notes on Energy Efficiency Class on page 92.

**LED** 3x Cabinet Spots Sensor



Typ	Code	EAN	Color	EEC kWh/1000h	mm	W	lm	K
Cabinet Spots Sensor	20000080	4004894850877	white	B / 8	14,5 x 12,5 x 5	7,5	120	3000
Cabinet Spots Sensor	20000081	4004894850884	silver	B / 8	14,5 x 12,5 x 5	7,5	120	3000

**QUICK & EASY** (incl. 140 cm Zuleitung / Cable électrique / Electric cable)

**ON/OFF** (IR Sensor / Capteur infrarouge / infrared sensor)

nicht dimmbar / non dimmable / not dimmable

Schutzklasse II / Classe de protection II / Protection class II

25.000 h / 100-240 V

nicht austauschbar / non remplaçable / not replaceable

**5 Jahre Garantie** / ans garantie / years warranty  
www.mueller-licht.de/garantie

Hinweise zur Energieeffizienzklasse auf Seite 92. / Les informations sur les catégories d'efficacité énergétique sont indiquées page 92. / Notes on Energy Efficiency Class on page 92.

**LED** Cabinet Light Flat Sensor



Typ	Code	EAN	Color	EEC kWh/1000h	mm	W	lm	K
Cabinet Light Flat Sensor 50	400095	4018412326652	silver	A / 8	500 x 28,7 x 9,6	7,5	400	4000
Cabinet Light Flat Sensor 50	400097	4018412326713	silver	A / 8	500 x 28,7 x 9,6	7,5	400	3000
Cabinet Light Flat Sensor 80	400096	4018412326683	silver	A / 11	800 x 28,7 x 9,6	11	700	4000
Cabinet Light Flat Sensor 80	400098	4018412326744	silver	A / 11	800 x 28,7 x 9,8	11	700	3000

**QUICK & EASY** (incl. 150 cm Zuleitung / Cable électrique / Electric cable)

**ON/OFF** (IR Sensor / Capteur infrarouge / infrared sensor)

integrierter Dimmer / Gradateur intégré / integrated dimmer

Schutzklasse II / Classe de protection II / Protection class II

25.000 h / 230 V

nicht austauschbar / non remplaçable / not replaceable

**5 Jahre Garantie** / ans garantie / years warranty  
www.mueller-licht.de/garantie

Hinweise zur Energieeffizienzklasse auf Seite 92. / Les informations sur les catégories d'efficacité énergétique sont indiquées page 92. / Notes on Energy Efficiency Class on page 92.

**LED** 4x Cabinet Spots Flat



Typ	Code	EAN	Color	EEC kWh/1000h	mm	W	lm	K
Cabinet Spots Flat	400077	4018412326119	white	B / 7	55 x 55 x 10	7	230	3000
Cabinet Spots Flat	400078	4018412326140	white	A / 7	55 x 55 x 10	7	300	4000

**QUICK & EASY** (incl. 150 cm Zuleitung / Cable électrique / Electric cable)

nicht dimmbar / non dimmable / not dimmable

Schutzklasse II / Classe de protection II / Protection class II

10.000 h / 230 V

nicht austauschbar / non remplaçable / not replaceable

**5 Jahre Garantie** / ans garantie / years warranty  
www.mueller-licht.de/garantie

Hinweise zur Energieeffizienzklasse auf Seite 92. / Les informations sur les catégories d'efficacité énergétique sont indiquées page 92. / Notes on Energy Efficiency Class on page 92.

**LED** 4x Cabinet Spots Flat



Typ	Code	EAN	Color	EEC kWh/1000h	mm	W	lm	K
Cabinet Spots Flat	400079	4018412326171	white	C / 8	55 x 55 x 10	7,5	70	RGB

**QUICK & EASY** (incl. 150 cm Zuleitung / Cable électrique / Electric cable)

incl. Fernbedienung / Télécommande / Remote control

**RGB**

Dimmbar mit Fernbedienung / Atténuable avec télécommande / Dimmable with remote

Schutzklasse II / Classe de protection II / Protection class II

10.000 h / 230 V

nicht austauschbar / non remplaçable / not replaceable

**5 Jahre Garantie** / ans garantie / years warranty  
www.mueller-licht.de/garantie

Hinweise zur Energieeffizienzklasse auf Seite 92. / Les informations sur les catégories d'efficacité énergétique sont indiquées page 92. / Notes on Energy Efficiency Class on page 92.

**LED** Cabinet Light French Plug



Typ	Code	EAN	Color	EEC kWh/1000h	mm	W	lm	K
Cabinet Light French Plug 45	20000079	4004894850853	silver	A / 5	449 x 87 x 49	5	270	4000

**ON/OFF SWITCH**

incl. Steckdose FR / Sockle FR / Socket FR

nicht dimmbar / non dimmable / not dimmable

Schutzklasse I / Classe de protection I / Protection class I

25.000 h / 220-240 V

nicht austauschbar / non remplaçable / not replaceable

Hinweise zur Energieeffizienzklasse auf Seite 92. / Les informations sur les catégories d'efficacité énergétique sont indiquées page 92. / Notes on Energy Efficiency Class on page 92.



## LEUCHTEN FÜR BADEZIMMER

Die formschönen MÜLLER-LICHT Badezimmerleuchten bieten höchste Lichtqualität.

### LUMIERES POUR LA SALLE DE BAIN

Les ravissantes lumières pour la salle de bain MÜLLER offrent un niveau de qualité lumineuse élevé.

### LAMPS FOR BATHROOMS

The attractive MÜLLER-LICHT bathroom luminaires offer high-quality lighting.

#### LED Mirror Light IP44



Typ	Code	EAN	Color	EEC kWh/1000h		W	lm	K
Mirror Light IP44 60	20200171	4004894539499	silver	A+ / 8	596 x 38 x 56	8	680	3000
Mirror Light IP44 60	20200180	4004894849406	chrome	A+ / 10	596 x 38 x 56	10	700	3000

**IP 44**

IP-Klasse  
Classe IP  
IP class



nicht dimmbar  
non dimmable  
not dimmable



Schutzklasse II  
Classe de protection II  
Protection class II

25.000 h

230 V



nicht austauschbar  
non remplaçable  
not replaceable

**5**

Jahre Garantie  
ans garantie  
years warranty  
[www.mueller-licht.de/garantie](http://www.mueller-licht.de/garantie)

Hinweise zur Energieeffizienzklasse auf Seite 92. / Les informations sur les catégories d'efficacité énergétique sont indiquées page 92. / Notes on Energy Efficiency Class on page 92.

### HINWEIS

Die folgenden Leuchten sind nur für Frankreich verfügbar.

### REMARQUE

Les modèles de lumière suivants ne sont disponibles qu'en France.

### PLEASE NOTE

Following luminaires are only available for France.

### LED Mirror Light

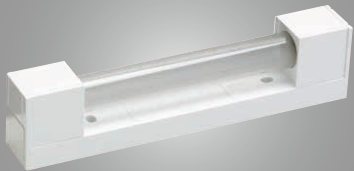

Typ	Code	EAN	Color	EEC kWh/1000h	mm	W	lm	K	
Mirror Light 35	20200162	4004894535002	white	A+ / 6	367 x 56 x 85	6	500	3000	
IP 21 IP-Klasse Classe IP IP class	incl. S19	austauschbar remplaçable replaceable	nicht dimmbar non dimmable not dimmable	Schutzklasse II Classe de protection II Protection class II	25.000 h 220-240 V	> 100.000 x Schaltungen Cycles de commutation Switch cycles			

Hinweise zur Energieeffizienzklasse auf Seite 92. / Les informations sur les catégories d'efficacité énergétique sont indiquées page 92. / Notes on Energy Efficiency Class on page 92.

### LED Mirror Light Plug

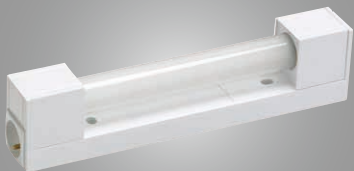

Typ	Code	EAN	Color	EEC kWh/1000h	mm	W	lm	K	
Mirror Light Plug 35	20200164	4004894535026	white	A+ / 6	369 x 56 x 85	6	500	3000	
IP 21 IP-Klasse Classe IP IP class	incl. S19	austauschbar remplaçable replaceable	Steckdose FR Socle FR Socket FR	nicht dimmbar non dimmable not dimmable	Schutzklasse I Classe de protection I Protection class I	25.000 h 220-240 V	> 100.000 x Schaltungen Cycles de commutation Switch cycles		

Hinweise zur Energieeffizienzklasse auf Seite 92. / Les informations sur les catégories d'efficacité énergétique sont indiquées page 92. / Notes on Energy Efficiency Class on page 92.

### LED Mirror Light Prisma

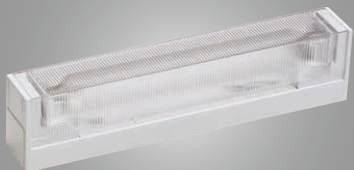

Typ	Code	EAN	Color	EEC kWh/1000h	mm	W	lm	K	
Mirror Light Prisma 35	20200165	4004894535033	white	A+ / 6	367 x 56 x 85	6	500	3000	
IP 21 IP-Klasse Classe IP IP class	incl. S19	austauschbar remplaçable replaceable	nicht dimmbar non dimmable not dimmable	Schutzklasse II Classe de protection II Protection class II	25.000 h 220-240 V	> 100.000 x Schaltungen Cycles de commutation Switch cycles			

Hinweise zur Energieeffizienzklasse auf Seite 92. / Les informations sur les catégories d'efficacité énergétique sont indiquées page 92. / Notes on Energy Efficiency Class on page 92.

### LED Mirror Light Prisma Plug

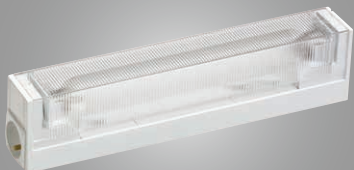

Typ	Code	EAN	Color	EEC kWh/1000h	mm	W	lm	K	
Mirror Light Prisma Plug 35	20200167	4004894535057	white	A+ / 6	369 x 56 x 85	6	500	3000	
IP 21 IP-Klasse Classe IP IP class	incl. S19	austauschbar remplaçable replaceable	Steckdose FR Socle FR Socket FR	nicht dimmbar non dimmable not dimmable	Schutzklasse I Classe de protection I Protection class I	25.000 h 220-240 V	> 100.000 x Schaltungen Cycles de commutation Switch cycles		

Hinweise zur Energieeffizienzklasse auf Seite 92. / Les informations sur les catégories d'efficacité énergétique sont indiquées page 92. / Notes on Energy Efficiency Class on page 92.

Das passende Ersatz-Leuchtmittel, für die oben aufgeführten Artikel, finden Sie auf Seite 10. / Vous trouverez page 10 le bon modèle de rechange pour l'article indiqué ci-dessus. / Suitable replacement lamps for above shown products please find on page 10.

### LT Mirror Light Plug IP41



Typ	Code	EAN	Color	EEC kWh/1000h	mm	W	lm	K		
Mirror Light Plug IP41 60	20200156	4004894178742	white	A / 15	602 x 90 x 60	13	950	4000		
IP 41 IP-Klasse Classe IP IP class	ON/OFF SWITCH	austauschbar remplaçable replaceable	Steckdose FR Socle FR Socket FR	ELECTRONIC BALLAST INSIDE	austauschbar remplaçable replaceable	incl.  Tube G5 Tube G5 Tube G5	nicht dimmbar non dimmable not dimmable	Schutzklasse I Classe de protection I Protection class I	8.000 h 220-240 V	> 10.000 x Schaltungen Cycles de commutation Switch cycles

Hinweise zur Energieeffizienzklasse auf Seite 92. / Les informations sur les catégories d'efficacité énergétique sont indiquées page 92. / Notes on Energy Efficiency Class on page 92.

Das passende Ersatz-Leuchtmittel finden Sie auf Seite 28. / Vous trouverez page 28 la bonne solution lumineuse. / Suitable replacement lamps please find on page 28.



## MODERNE, ZIELGERICHTETE BELEUCHTUNG

Die Einbauspotlights von MÜLLER-LICHT überzeugen nicht nur durch austauschbare, nachbestellbare Module und Leuchtmittel, sondern auch durch ihre flache Einbautiefe sowie eine einfache Montage. Alle Einbauspotlights werden aus hochwertigen Metallen und Aluminiumgehäusen hergestellt.

### UN ECLAIRAGE MODERNE ET CIBLE

Les spots encastrés de MÜLLER-LICHT sauront vous convaincre grâce à leurs modules et ampoules échangeables et remplaçables, leur style épuré et leur montage facile. Tous les spots encastrés sont fabriqués avec des boîtiers en aluminium et métal de qualité.

### MODERN, FOCUSED LIGHTING

The downlight spots from MÜLLER-LICHT do not only convince by their replaceable modules and lamps, but also with flat installation depth and simple installation. All downlight spots are made of high quality metals.

### LED Downlight



Typ	Code	EAN	Color	EEC kWh/1000h	mm	W	lm	K
Downlight · 1/BOX	21520000	4004894850051	white	A+ / 5	78 x 25	5	300	2700
Downlight · 3/BOX	21520001	4004894850068	white	A+ / 5	78 x 25	5	300	2700
Downlight · 1/BOX	21520002	4004894850075	chrome	A+ / 5	78 x 25	5	300	2700
Downlight · 3/BOX	21520003	4004894850082	chrome	A+ / 5	78 x 25	5	300	2700
Downlight · 1/BOX	21520004	4004894850099	satin	A+ / 5	78 x 25	5	300	2700
Downlight · 3/BOX	21520005	4004894850105	satin	A+ / 5	78 x 25	5	300	2700

- QUICK & EASY** (Wrench and screwdriver icon)
- Federklemme / Pince a ressort / Spring terminal (Terminal icon)
- TIP 20 / JIP 23 (Light bulb icon)
- austauschbar / remplaçable / replaceable (Light bulb icon)
- incl. GU10 (GU10 bulb icon)
- starr / rigide / fixed (Light fixture icon)
- 30° Abstrahlwinkel / Angle d'éclairage / Beam angle (Light beam icon)
- Ø 68 mm Deckenausschnitt / Découpage du faux-plafond / Installation dimension (Cutout icon)
- 60 mm Einbautiefe / Profondeur utile / Mounting depth (Depth icon)
- nicht dimmbar / non dimmable / not dimmable (No dimmer icon)
- Schutzklasse II / Classe de protection II / Protection class II (Safety icon)
- 25.000 h / 220-240 V (Lifetime icon)
- > 100.000 x Schaltungen / Cycles de commutation / Switch cycles (Switch icon)

Hinweise zur Energieeffizienzklasse auf Seite 92. / Les informations sur les catégories d'efficacité énergétique sont indiquées page 92. / Notes on Energy Efficiency Class on page 92.

Das passende Ersatz-Leuchtmittel finden Sie auf Seite 8, 12 und 16. / Vous trouverez page 8, 12 et 16 la bonne solution lumineuse. / Suitable replacement lamps please find on page 8, 12 and 16.

### LED Downlight

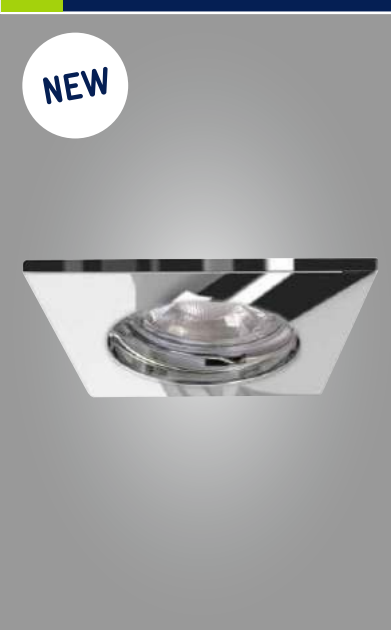



Typ	Code	EAN	Color	EEC kWh/1000h	mm	W	lm	K
Downlight · 1/BOX	21520006	4004894850112	white	A+ / 5	80 x 80 x 32	5	300	2700
Downlight · 3/BOX	21520007	4004894850129	white	A+ / 5	80 x 80 x 32	5	300	2700
Downlight · 1/BOX	21520008	4004894850136	chrome	A+ / 5	80 x 80 x 32	5	300	2700
Downlight · 3/BOX	21520009	4004894850143	chrome	A+ / 5	80 x 80 x 32	5	300	2700
Downlight · 1/BOX	21520010	4004894850150	satin	A+ / 5	80 x 80 x 32	5	300	2700
Downlight · 3/BOX	21520011	4004894850167	satin	A+ / 5	80 x 80 x 32	5	300	2700

- QUICK & EASY** (Wrench and screwdriver icon)
- Federklemme / Pince a ressort / Spring terminal (Terminal icon)
- TIP 20 / JIP 23 (Light bulb icon)
- austauschbar / remplaçable / replaceable (Light bulb icon)
- incl. GU10 (GU10 bulb icon)
- starr / rigide / fixed (Light fixture icon)
- 30° Abstrahlwinkel / Angle d'éclairage / Beam angle (Light beam icon)
- Ø 68 mm Deckenausschnitt / Découpage du faux-plafond / Installation dimension (Cutout icon)
- 60 mm Einbautiefe / Profondeur utile / Mounting depth (Depth icon)
- nicht dimmbar / non dimmable / not dimmable (No dimmer icon)
- Schutzklasse II / Classe de protection II / Protection class II (Safety icon)
- 25.000 h / 220-240 V (Lifetime icon)
- > 100.000 x Schaltungen / Cycles de commutation / Switch cycles (Switch icon)













Hinweise zur Energieeffizienzklasse auf Seite 92. / Les informations sur les catégories d'efficacité énergétique sont indiquées page 92. / Notes on Energy Efficiency Class on page 92.

Das passende Ersatz-Leuchtmittel finden Sie auf Seite 8, 12 und 16. / Vous trouverez page 8, 12 et 16 la bonne solution lumineuse. / Suitable replacement lamps please find on page 8, 12 and 16.

## LED Downlight



 	Typ	Code	EAN	Color	EEC kWh/1000h		W	lm	K
	Downlight · 1/BOX	21520012	4004894850174	white	A+ / 5	82 x 24	5	300	2700
	Downlight · 3/BOX	21520013	4004894850181	white	A+ / 5	82 x 24	5	300	2700
	Downlight · 1/BOX	21520014	4004894850198	chrome	A+ / 5	82 x 24	5	300	2700
	Downlight · 3/BOX	21520015	4004894850204	chrome	A+ / 5	82 x 24	5	300	2700
	Downlight · 1/BOX	21520016	4004894850211	satin	A+ / 5	82 x 24	5	300	2700
	Downlight · 3/BOX	21520017	4004894850228	satin	A+ / 5	82 x 24	5	300	2700













	 Federklemme Pince a ressort Spring terminal	 TIP 20 ↓ IP 23	 austauschbar remplaçable replaceable	 incl. GU10	 25° schwenkbar pivotant swiveling	 30° Abstrahlwinkel Angle d'éclairage Beam angle	 Ø 68 mm Deckenausschnitt Découpage du faux-plafond Installation dimension	 60 mm Einbautiefe Profondeur utile Mounting depth
 nicht dimmbar non dimmable not dimmable	 Schutzklasse II Classe de protection II Protection class II	25.000 h 220-240 V	 > 100.000 x Schaltungen Cycles de commutation Switch cycles	Hinweise zur Energieeffizienzklasse auf Seite 92. / Les informations sur les catégories d'efficacité énergétique sont indiquées page 92. / Notes on Energy Efficiency Class on page 92.				

Das passende Ersatz-Leuchtmittel finden Sie auf Seite 8, 12 und 16. / Vous trouverez page 8, 12 et 16 la bonne solution lumineuse. / Suitable replacement lamps please find on page 8, 12 and 16.

## LED Downlight



 	Typ	Code	EAN	Color	EEC kWh/1000h		W	lm	K
	Downlight · 1/BOX	21520018	4004894850235	white	A+ / 5	85 x 85 x 29	5	300	2700
	Downlight · 3/BOX	21520019	4004894850242	white	A+ / 5	85 x 85 x 29	5	300	2700
	Downlight · 1/BOX	21520020	4004894850259	chrome	A+ / 5	85 x 85 x 29	5	300	2700
	Downlight · 3/BOX	21520021	4004894850266	chrome	A+ / 5	85 x 85 x 29	5	300	2700
	Downlight · 1/BOX	21520022	4004894850273	satin	A+ / 5	85 x 85 x 29	5	300	2700
	Downlight · 3/BOX	21520023	4004894850280	satin	A+ / 5	85 x 85 x 29	5	300	2700













	 Federklemme Pince a ressort Spring terminal	 TIP 20 ↓ IP 23	 austauschbar remplaçable replaceable	 incl. GU10	 25° schwenkbar pivotant swiveling	 30° Abstrahlwinkel Angle d'éclairage Beam angle	 Ø 68 mm Deckenausschnitt Découpage du faux-plafond Installation dimension	 60 mm Einbautiefe Profondeur utile Mounting depth
 nicht dimmbar non dimmable not dimmable	 Schutzklasse II Classe de protection II Protection class II	25.000 h 220-240 V	 > 100.000 x Schaltungen Cycles de commutation Switch cycles	Hinweise zur Energieeffizienzklasse auf Seite 92. / Les informations sur les catégories d'efficacité énergétique sont indiquées page 92. / Notes on Energy Efficiency Class on page 92.				

Das passende Ersatz-Leuchtmittel finden Sie auf Seite 8, 12 und 16. / Vous trouverez page 8, 12 et 16 la bonne solution lumineuse. / Suitable replacement lamps please find on page 8, 12 and 16.

## LED Downlight Flat

 	Typ	Code	EAN	Color	EEC kWh/1000h		W	lm	K
	Downlight Flat · 1/BOX	21520030	4004894850433	white	A+ / 5	82 x 24	5	400	2700
	Downlight Flat · 3/BOX	21520031	4004894850440	white	A+ / 5	82 x 24	5	400	2700
	Downlight Flat · 1/BOX	21520032	4004894850457	satin	A+ / 5	82 x 24	5	400	2700
	Downlight Flat · 3/BOX	21520033	4004894850464	satin	A+ / 5	82 x 24	5	400	2700

	 Federklemme Pince a ressort Spring terminal	 TIP 20 ↓ IP 23	 austauschbar remplaçable replaceable	 incl. Modul Module Module	 25° schwenkbar pivotant swiveling	 100° Abstrahlwinkel Angle d'éclairage Beam angle	 Ø 68 mm Deckenausschnitt Découpage du faux-plafond Installation dimension	 40 mm Einbautiefe Profondeur utile Mounting depth
 nicht dimmbar non dimmable not dimmable	 Schutzklasse II Classe de protection II Protection class II	25.000 h 220-240 V	 > 30.000 x Schaltungen Cycles de commutation Switch cycles	Hinweise zur Energieeffizienzklasse auf Seite 92. / Les informations sur les catégories d'efficacité énergétique sont indiquées page 92. / Notes on Energy Efficiency Class on page 92.				

Das passende Ersatz-Leuchtmittel finden Sie auf Seite 76. / Vous trouverez page 76 la bonne solution lumineuse. / Suitable replacement lamps please find on page 76.

### LED Downlight Flat



**NEW**

Typ	Code	EAN	Color	EEC kWh/1000h	mm	W	lm	K
Downlight Flat · 1/BOX	21520024	4004894850372	white	A+ / 5	78 x 25	5	400	2700
Downlight Flat · 3/BOX	21520025	4004894850389	white	A+ / 5	78 x 25	5	400	2700
Downlight Flat · 1/BOX	21520026	4004894850396	chrome	A+ / 5	78 x 25	5	400	2700
Downlight Flat · 3/BOX	21520027	4004894850402	chrome	A+ / 5	78 x 25	5	400	2700
Downlight Flat · 1/BOX	21520028	4004894850419	satin	A+ / 5	78 x 25	5	400	2700
Downlight Flat · 3/BOX	21520029	4004894850426	satin	A+ / 5	78 x 25	5	400	2700

- QUICK & EASY** Federklemme Pince a ressort Spring terminal
- TIP 20 IIP 23
- austauschbar remplaçable replaceable
- incl. Modul Module
- starr rigide fixed
- 100° Abstrahlwinkel Angle d'éclairage Beam angle
- Ø 68 mm Deckenausschnitt Découpage du faux-plafond Installation dimension
- 40 mm Einbautiefe Profondeur utile Mounting depth
- nicht dimmbar non dimmable not dimmable
- Schutzklasse II Classe de protection II Protection class II
- 25.000 h 220-240 V
- > 30.000 x Schaltungen Cycles de commutation Switch cycles

Hinweise zur Energieeffizienzklasse auf Seite 92. / Les informations sur les catégories d'efficacité énergétique sont indiquées page 92. / Notes on Energy Efficiency Class on page 92.

Das passende Ersatz-Leuchtmittel finden Sie auf Seite 76. / Vous trouverez page 76 la bonne solution lumineuse. / Suitable replacement lamps please find on page 76.

### LED Downlight DIM



**NEW**  
**HD LED**

Typ	Code	EAN	Color	EEC kWh/1000h	mm	W	lm	K
Downlight DIM · 1/BOX	21530000	4004894850297	white	A / 7	78 x 25	7	400	2700
Downlight DIM · 3/BOX	21530001	4004894850303	white	A / 7	78 x 25	7	400	2700
Downlight DIM · 1/BOX	21530002	4004894850310	satin	A / 7	78 x 25	7	400	2700
Downlight DIM · 3/BOX	21530003	4004894850327	satin	A / 7	78 x 25	7	400	2700

- QUICK & EASY** Federklemme Pince a ressort Spring terminal
- TIP 20 IIP 23
- dimmbar dimmable dimmable
- incl. GU10
- starr rigide fixed
- 40° Abstrahlwinkel Angle d'éclairage Beam angle
- Ø 68 mm Deckenausschnitt Découpage du faux-plafond Installation dimension
- 60 mm Einbautiefe Profondeur utile Mounting depth
- Schutzklasse II Classe de protection II Protection class II
- 25.000 h 220-240 V Ra ≥90
- > 100.000 x Schaltungen Cycles de commutation Switch cycles

Hinweise zur Energieeffizienzklasse auf Seite 92. / Les informations sur les catégories d'efficacité énergétique sont indiquées page 92. / Notes on Energy Efficiency Class on page 92.

Das passende Ersatz-Leuchtmittel finden Sie auf Seite 8, 12 und 16. / Vous trouverez page 8, 12 et 16 la bonne solution lumineuse. / Suitable replacement lamps please find on page 8, 12 and 16.

### LED Downlight DIM



**NEW**  
**HD LED**

Typ	Code	EAN	Color	EEC kWh/1000h	mm	W	lm	K
Downlight DIM · 1/BOX	21530004	4004894850334	white	A / 7	82 x 24	7	400	2700
Downlight DIM · 3/BOX	21530005	4004894850341	white	A / 7	82 x 24	7	400	2700
Downlight DIM · 1/BOX	21530006	4004894850358	satin	A / 7	82 x 24	7	400	2700
Downlight DIM · 3/BOX	21530007	4004894850365	satin	A / 7	82 x 24	7	400	2700

- QUICK & EASY** Federklemme Pince a ressort Spring terminal
- TIP 20 IIP 23
- dimmbar dimmable dimmable
- incl. GU10
- 25° schwenkbar pivotant swiveling
- 40° Abstrahlwinkel Angle d'éclairage Beam angle
- Ø 68 mm Deckenausschnitt Découpage du faux-plafond Installation dimension
- 60 mm Einbautiefe Profondeur utile Mounting depth
- Schutzklasse II Classe de protection II Protection class II
- 25.000 h 220-240 V Ra ≥90
- > 100.000 x Schaltungen Cycles de commutation Switch cycles

Hinweise zur Energieeffizienzklasse auf Seite 92. / Les informations sur les catégories d'efficacité énergétique sont indiquées page 92. / Notes on Energy Efficiency Class on page 92.

Das passende Ersatz-Leuchtmittel finden Sie auf Seite 8, 12 und 16. / Vous trouverez page 8, 12 et 16 la bonne solution lumineuse. / Suitable replacement lamps please find on page 8, 12 and 16.

## LED Downlight DIM Flat

**NEW**

**HD LED**



Typ	Code	EAN	Color	EEC kWh/1000h	mm	W	lm	K
Downlight DIM Flat · 1/BOX	21530008	4004894850471	white	A+ / 5	78 x 25	5	400	2700
Downlight DIM Flat · 3/BOX	21530009	4004894850488	white	A+ / 5	78 x 25	5	400	2700
Downlight DIM Flat · 1/BOX	21530010	4004894850495	satin	A+ / 5	78 x 25	5	400	2700
Downlight DIM Flat · 3/BOX	21530011	4004894850501	satin	A+ / 5	78 x 25	5	400	2700
Downlight DIM Flat · 1/BOX	21530012	4004894850518	chrome	A+ / 5	78 x 25	5	400	2700
Downlight DIM Flat · 3/BOX	21530013	4004894850525	chrome	A+ / 5	78 x 25	5	400	2700

**QUICK & EASY** Federklemme Pince a ressort Spring terminal

**dimmar dimmable dimmable**

**Modul Module Module**

**starr rigide fixed**

**100°** Abstrahlwinkel Angle d'éclairage Beam angle

**Ø 68 mm** Deckenausschnitt Découpage du faux-plafond Installation dimension

**45 mm** Einbautiefe Profondeur utile Mounting depth

**25.000 h** **220-240 V** **Ra ≥90**

**> 30.000 x** Schaltungen Cycles de commutation Switch cycles

Schutzklasse II Classe de protection II Protection class II

Hinweise zur Energieeffizienzklasse auf Seite 92. / Les informations sur les catégories d'efficacité énergétique sont indiquées page 92. / Notes on Energy Efficiency Class on page 92.

Das passende Ersatz-Leuchtmittel finden Sie auf Seite 76. / Vous trouverez page 76 la bonne solution lumineuse. / Suitable replacement lamps please find on page 76.

## LED Downlight DIM Flat

**NEW**

**HD LED**



Typ	Code	EAN	Color	EEC kWh/1000h	mm	W	lm	K
Downlight DIM Flat · 1/BOX	21530014	4004894850532	white	A+ / 5	82 x 24	5	400	2700
Downlight DIM Flat · 3/BOX	21530015	4004894850549	white	A+ / 5	82 x 24	5	400	2700
Downlight DIM Flat · 1/BOX	21530016	4004894850556	satin	A+ / 5	82 x 24	5	400	2700
Downlight DIM Flat · 3/BOX	21530017	4004894850563	satin	A+ / 5	82 x 24	5	400	2700

**QUICK & EASY** Federklemme Pince a ressort Spring terminal

**dimmar dimmable dimmable**

**Modul Module Module**

**25°** schwenkbar pivotant swiveling

**100°** Abstrahlwinkel Angle d'éclairage Beam angle

**Ø 68 mm** Deckenausschnitt Découpage du faux-plafond Installation dimension

**45 mm** Einbautiefe Profondeur utile Mounting depth

**25.000 h** **220-240 V** **Ra ≥90**

**> 30.000 x** Schaltungen Cycles de commutation Switch cycles

Schutzklasse II Classe de protection II Protection class II

Hinweise zur Energieeffizienzklasse auf Seite 92. / Les informations sur les catégories d'efficacité énergétique sont indiquées page 92. / Notes on Energy Efficiency Class on page 92.

Das passende Ersatz-Leuchtmittel finden Sie auf Seite 76. / Vous trouverez page 76 la bonne solution lumineuse. / Suitable replacement lamps please find on page 76.

## Module / Modules / Modules

**HD LED**

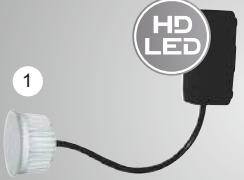



1















2

1	400219	Modul / Module / Module <b>HD-LED</b>
2	400220	Modul / Module / Module

### LED Happy Price Downlight







Typ	Code	EAN	Color	EEC kWh/1000h		W	lm	K
Downlight · 3/BOX	21510000	4004894849970	white	A+ / 3	81 x 25	3	225	2700
Downlight · 5/BOX	21510001	4004894849987	white	A+ / 3	81 x 25	3	225	2700
Downlight · 3/BOX	21510002	4004894849994	satın	A+ / 3	81 x 25	3	225	2700
Downlight · 5/BOX	21510003	4004894850006	satın	A+ / 3	81 x 25	3	225	2700













 <b>QUICK &amp; EASY</b>	 Federklemme Pince a ressort Spring terminal	 TIP 20 JIP 23	 austauschbar remplaçable replaceable	 incl. GU10	 starr rigide fixed	 110° Abstrahlwinkel Angle d'éclairage Beam angle	 Ø 68 mm Deckenausschnitt Découpage du faux-plafond Installation dimension	 60 mm Einbautiefe Profondeur utile Mounting depth
 nicht dimmbar non dimmable not dimmable	 Schutzklasse II Classe de protection II Protection class II	25.000 h 220-240 V	 > 100.000 x Schaltungen Cycles de commutation Switch cycles	Hinweise zur Energieeffizienzklasse auf Seite 92. / Les informations sur les catégories d'efficacité énergétique sont indiquées page 92. / Notes on Energy Efficiency Class on page 92.				

Das passende Ersatz-Leuchtmittel finden Sie auf Seite 8, 12 und 16. / Vous trouverez page 8, 12 et 16 la bonne solution lumineuse. / Suitable replacement lamps please find on page 8, 12 and 16.









### LED Happy Price Downlight

Typ	Code	EAN	Color	EEC kWh/1000h		W	lm	K
Downlight · 3/BOX	21510004	4004894850013	white	A+ / 3	88 x 29	3	225	2700
Downlight · 5/BOX	21510005	4004894850020	white	A+ / 3	88 x 29	3	225	2700
Downlight · 3/BOX	21510006	4004894850037	satın	A+ / 3	88 x 29	3	225	2700
Downlight · 5/BOX	21510007	4004894850044	satın	A+ / 3	88 x 29	3	225	2700

 <b>QUICK &amp; EASY</b>	 Federklemme Pince a ressort Spring terminal	 TIP 20 JIP 23	 austauschbar remplaçable replaceable	 incl. GU10	 25° schwenkbar pivotant swiveling	 110° Abstrahlwinkel Angle d'éclairage Beam angle	 Ø 68 mm Deckenausschnitt Découpage du faux-plafond Installation dimension	 60 mm Einbautiefe Profondeur utile Mounting depth
 nicht dimmbar non dimmable not dimmable	 Schutzklasse II Classe de protection II Protection class II	25.000 h 220-240 V	 > 100.000 x Schaltungen Cycles de commutation Switch cycles	Hinweise zur Energieeffizienzklasse auf Seite 92. / Les informations sur les catégories d'efficacité énergétique sont indiquées page 92. / Notes on Energy Efficiency Class on page 92.				

Das passende Ersatz-Leuchtmittel finden Sie auf Seite 8, 12 und 16. / Vous trouverez page 8, 12 et 16 la bonne solution lumineuse. / Suitable replacement lamps please find on page 8, 12 and 16.

	W		lm	Ra			V	K			Box/ Blister		
-	5	-	400	≥ 90	110	A+	220-240	2700	✓	50 x 30	1/BOX	4	25.000
-	5	-	400	≥ 80	110	A+	220-240	2700	-	50 x 26	1/BOX	4	25.000

## AKTIONS- UND PROMOWARE

Promotionware für starke Preispunkte. Sorgen Sie gezielt für Zusatzumsatz mit den speziell für Zweitplatzierungen entwickelten MÜLLER-LICHT Aktions- und Promoartikeln.

### PROMOTIONS ET ACTIONS

Des promotions à des tarifs attractifs. Assurez-vous un chiffre d'affaires ciblé supplémentaire grâce aux articles en promotions et aux actions spéciales de MÜLLER-LICHT, présentées sous la forme d'offres secondaires.

### CAMPAIGN AND PROMOTIONAL GOODS

Promotional products at competitive price points. Boost your sales with especially for the second placement developed campaign- and promotion items.

### LED Aqua-Promo



Typ	Code	EAN	Color	EEC kWh/1000h		W	lm	K
Aqua-Promo 1 / 60	20800154	4004894545339	gray	A+ / 10	650 x 74 x 87	10	950	4000
Aqua-Promo 2 / 60	20800155	4004894545346	gray	A+ / 10	650 x 116 x 87	10	950	4000
Aqua-Promo 1 / 120	20800156	4004894545353	gray	A+ / 18	1263 x 74 x 87	18	1800	4000
Aqua-Promo 2 / 120	20800157	4004894545360	gray	A+ / 18	1263 x 116 x 87	18	1800	4000
Aqua-Promo 1 / 150	20800158	4004894545377	gray	A+ / 22	1565 x 74 x 87	22	2100	4000
Aqua-Promo 2 / 150	20800159	4004894545384	gray	A+ / 22	1565 x 116 x 87	22	2100	4000

**IP 65**

IP-Klasse  
Classe IP  
IP class



austauschbar  
remplaçable  
replaceable



incl.  
LED-Tube G13  
Tube LED G13  
LED tube G13



nicht dimmbar  
non dimmable  
not dimmable



Schutzklasse I  
Classe de protection I  
Protection class I

25.000 h  
220-240 V



> 100.000 x  
Schaltungen  
Cycles de commutation  
Switch cycles

Hinweise zur Energieeffizienzklasse auf Seite 92. / Les informations sur les catégories d'efficacité énergétique sont indiquées page 92. / Notes on Energy Efficiency Class on page 92.

Das passende Ersatz-Leuchtmittel finden Sie auf Seite 10. / Vous trouverez page 10 la bonne solution lumineuse. / Suitable replacement lamps please find on page 10.

### LED Aqua-Promo INT



Typ	Code	EAN	Color	EEC kWh/1000h		W	lm	K
Aqua-Promo 1 INT / 60	20800164	4004894546572	gray	A+ / 12	658 x 100 x 101	12	900	4000
Aqua-Promo 2 INT / 60	20800165	4004894546589	gray	A+ / 24	658 x 158 x 101	24	1800	4000
Aqua-Promo 1 INT / 120	20800166	4004894546596	gray	A+ / 24	1268 x 100 x 101	24	1800	4000
Aqua-Promo 2 INT / 120	20800167	4004894546602	gray	A+ / 45	1268 x 158 x 101	45	3500	4000
Aqua-Promo 1 INT / 150	20800168	4004894546619	gray	A+ / 35	1568 x 100 x 101	35	2600	4000
Aqua-Promo 2 INT / 150	20800169	4004894546626	gray	A+ / 68	1568 x 158 x 101	68	5100	4000

**IP 65**

IP-Klasse  
Classe IP  
IP class



nicht dimmbar  
non dimmable  
not dimmable



Schutzklasse I  
Classe de protection I  
Protection class I

30.000 h  
220-240 V



nicht austauschbar  
non remplaçable  
not replaceable

**5** Jahre Garantie  
ans garantie  
years warranty  
www.mueller-licht.de/garantie

Hinweise zur Energieeffizienzklasse auf Seite 92. / Les informations sur les catégories d'efficacité énergétique sont indiquées page 92. / Notes on Energy Efficiency Class on page 92.

LT Ceiling Light T8

Typ	Code	EAN	Color	EEC kWh/1000h		W	lm	K
Ceiling Light T8 60	20800124	4004894489664	white	A / 23	615 x 35 x 55	18	1300	4000
Ceiling Light T8 120	20800125	4004894489671	white	A / 43	1225 x 32 x 55	36	3200	4000
Ceiling Light T8 150	20800126	4004894489688	white	A / 68	1526 x 35 x 55	58	4500	4000

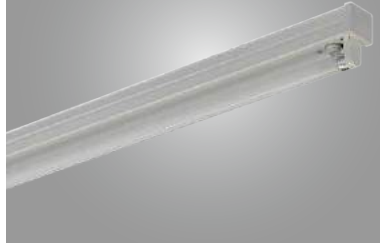

austauschbar  
remplaçable  
replaceable  
**ELECTRONIC BALLAST INSIDE**  
 nicht dimmbar  
non dimmable  
not dimmable  
 Schutzklasse II  
Classe de protection II  
Protection class II  
**20.000 h**  
**220-240 V**  
 > 10.000 x  
Schaltungen  
Cycles de commutation  
Switch cycles

Hinweise zur Energieeffizienzklasse auf Seite 92. / Les informations sur les catégories d'efficacité énergétique sont indiquées page 92. / Notes on Energy Efficiency Class on page 92.

Das passende Ersatz-Leuchtmittel finden Sie auf Seite 28. / Vous trouverez page 28 la bonne solution lumineuse. / Suitable replacement lamps please find on page 28.

LED Lightbar

Typ	Code	EAN	Color	EEC kWh/1000h		W	lm	K
Lightbar 60	20800152	4004894544554	silver	A+ / 10	600 x 29 x 44	10	950	4000
Lightbar 120	20800153	4004894544561	silver	A+ / 20	1200 x 29 x 44	20	1800	4000
Lightbar 150	20800170	4004894848799	silver	A+ / 24	1500 x 29 x 44	24	2400	4100



nicht dimmbar  
non dimmable  
not dimmable  
 Schutzklasse II  
Classe de protection II  
Protection class II  
**25.000 h**  
**220-240 V**  
 nicht austauschbar  
non remplaçable  
not replaceable  
**5 Jahre Garantie**  
**ans garantie**  
**years warranty**  
[www.mueller-licht.de/garantie](http://www.mueller-licht.de/garantie)

Hinweise zur Energieeffizienzklasse auf Seite 92. / Les informations sur les catégories d'efficacité énergétique sont indiquées page 92. / Notes on Energy Efficiency Class on page 92.

LT Aqua-Promo T8

Typ	Code	EAN	Color	EEC kWh/1000h		W	lm	K
Aqua-Promo T8 1 / 60	20800136	4004894515769	gray	A / 23	648 x 74 x 86	18	1300	4000
Aqua-Promo T8 2 / 60	20800139	4004894515790	gray	A / 22	650 x 116 x 87	18	1350	4000
Aqua-Promo T8 1 / 120	20800137	4004894515776	gray	A / 43	1261 x 73 x 85	36	3200	4000
Aqua-Promo T8 2 / 120	20800140	4004894515806	gray	A / 43	1263 x 116 x 87	36	3200	4000
Aqua-Promo T8 1 / 150	20800138	4004894515783	gray	A / 68	1565 x 74 x 87	58	4780	4000
Aqua-Promo T8 2 / 150	20800141	4004894515813	gray	A / 68	1565 x 116 x 87	58	4780	4000

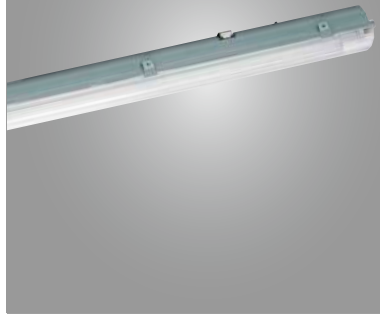

**IP 65**  
 IP-Klasse  
Classe IP  
IP class  
 austauschbar  
remplaçable  
replaceable  
**ELECTRONIC BALLAST INSIDE**  
 inkl.  
Tube G13  
Tube G13  
Tube G13  
 nicht dimmbar  
non dimmable  
not dimmable  
 Schutzklasse I  
Classe de protection I  
Protection class I  
**20.000 h**  
**220-240 V**  
 > 10.000 x  
Schaltungen  
Cycles de commutation  
Switch cycles

Hinweise zur Energieeffizienzklasse auf Seite 92. / Les informations sur les catégories d'efficacité énergétique sont indiquées page 92. / Notes on Energy Efficiency Class on page 92.

Das passende Ersatz-Leuchtmittel finden Sie auf Seite 28. / Vous trouverez page 28 la bonne solution lumineuse. / Suitable replacement lamps please find on page 28.

HAPPY  
PRICE:)

LED

## DAS VIELFÄLTIGE PREISEINSTIEGSSORTIMENT

Das Happy Price Sortiment von MÜLLER-LICHT umfasst qualitativ hochwertige Leuchten zu günstigen Einstiegspreisen.

### L'OFFRE PREMIER PRIX TRES VARIEE

La gamme Happy Price de MÜLLER-LICHT comprend des modèles de lumières de qualité proposés à des prix très abordables (modèles premiers prix).

### THE DIVERSE ENTRY-LEVEL ASSORTMENT

The Happy Price assortment from MÜLLER-LICHT consists of high-quality luminaires at affordable entry-level prices.

LED Cabinet Light DIM

Typ	Code	EAN	Color	EEC kWh/1000h	mm	W	lm	K
Cabinet Light DIM 35	20900275	4004894546794	white	A+ / 5	350 x 66 x 24	5,5	430	2900
Cabinet Light DIM 60	20900276	4004894546800	white	A+ / 9	580 x 66 x 24	8,5	690	2900

**QUICK & EASY**

incl. 180 cm  
Zuleitung  
Cable électrique  
Electric cable

koppelbar  
connectable  
connectable

**ON/OFF**  
**SWITCH**

integrierter Dimmer  
Gradateur intégré  
integrated dimmer

Schutzklasse II  
Classe de protection II  
Protection class II

25.000 h  
220-240 V

nicht austauschbar  
non remplaçable  
not replaceable

Hinweise zur Energieeffizienzklasse auf Seite 92. / Les informations sur les catégories d'efficacité énergétique sont indiquées page 92. / Notes on Energy Efficiency Class on page 92.

LED Cabinet Light Spots

Typ	Code	EAN	Color	EEC kWh/1000h	mm	W	lm	K
Cabinet Light Spots 50	20900277	4004894546817	white	A+ / 3	465 x 66 x 28	3	170	3100
Cabinet Light Spots 65	20900278	4004894546824	white	A+ / 4	610 x 66 x 28	4	230	3000

**QUICK & EASY**

incl. 180 cm  
Zuleitung  
Cable électrique  
Electric cable

koppelbar  
connectable  
connectable

**ON/OFF**  
**SWITCH**

nicht dimmbar  
non dimmable  
not dimmable

Schutzklasse II  
Classe de protection II  
Protection class II

25.000 h  
220-240 V

nicht austauschbar  
non remplaçable  
not replaceable

Hinweise zur Energieeffizienzklasse auf Seite 92. / Les informations sur les catégories d'efficacité énergétique sont indiquées page 92. / Notes on Energy Efficiency Class on page 92.

LED Cabinet Light Switch

Typ	Code	EAN	Color	EEC kWh/1000h	mm	W	lm	K
Cabinet Light Switch 30	20900279	4004894546831	white	A+ / 5	285 x 70 x 28	5	300	4100
Cabinet Light Switch 60	20900280	4004894546848	white	A+ / 10	585 x 70 x 28	9,5	700	4100

**QUICK & EASY**

incl. 180 cm  
Zuleitung  
Cable électrique  
Electric cable

koppelbar  
connectable  
connectable

**ON/OFF**  
**SWITCH**

nicht dimmbar  
non dimmable  
not dimmable

Schutzklasse II  
Classe de protection II  
Protection class II

25.000 h  
220-240 V

nicht austauschbar  
non remplaçable  
not replaceable

Hinweise zur Energieeffizienzklasse auf Seite 92. / Les informations sur les catégories d'efficacité énergétique sont indiquées page 92. / Notes on Energy Efficiency Class on page 92.

LED Cabinet Light Flat

Typ	Code	EAN	Color	EEC kWh/1000h	mm	W	lm	K
Cabinet Light Flat 45	20900281	4004894546855	white	A+ / 7	439 x 55 x 27	6,5	470	4100
Cabinet Light Flat 45	20900283	4004894546879	titan	A+ / 7	439 x 55 x 27	6,5	470	4100
Cabinet Light Flat 60	20900282	4004894546862	white	A+ / 10	599 x 55 x 27	10	700	4200
Cabinet Light Flat 60	20900284	4004894546886	titan	A+ / 10	599 x 55 x 27	10	700	4200

**QUICK & EASY**

incl. 180 cm  
Zuleitung  
Cable électrique  
Electric cable

**ON/OFF**  
**SWITCH**

nicht dimmbar  
non dimmable  
not dimmable



Schutzklasse II  
Classe de protection II  
Protection class II

25.000 h  
220-240 V

nicht austauschbar  
non remplaçable  
not replaceable

Hinweise zur Energieeffizienzklasse auf Seite 92. / Les informations sur les catégories d'efficacité énergétique sont indiquées page 92. / Notes on Energy Efficiency Class on page 92.

## LED Downlight

 	Typ	Code	EAN	Color	EEC kWh/1000h		W	lm	K
	Downlight · 3/BOX	21510000	4004894849970	white	A+ / 3	81 x 25	3	225	2700
	Downlight · 5/BOX	21510001	4004894849987	white	A+ / 3	81 x 25	3	225	2700
	Downlight · 3/BOX	21510002	4004894849994	satin	A+ / 3	81 x 25	3	225	2700
	Downlight · 5/BOX	21510003	4004894850006	satin	A+ / 3	81 x 25	3	225	2700

 **QUICK & EASY**

 Federklemme  
Pince a ressort  
Spring terminal

 ↑IP 20  
↓IP 23

 austauschbar  
remplaçable  
replaceable

 incl.  
GU10

 starr  
rigide  
fixed

 110°  
Abstrahlwinkel  
Angle d'éclairage  
Beam angle

 Ø 68 mm  
Deckenausschnitt  
Découpage du faux-plafond  
Installation dimension

 60 mm  
Einbautiefe  
Profondeur utile  
Mounting depth

 nicht dimmbar  
non dimmable  
not dimmable

 Schutzklasse II  
Classe de protection II  
Protection class II



25.000 h  
220-240 V

 > 100.000 x  
Schaltungen  
Cycles de commutation  
Switch cycles

Hinweise zur Energieeffizienzklasse auf Seite 92. / Les informations sur les catégories d'efficacité énergétique sont indiquées page 92. / Notes on Energy Efficiency Class on page 92.

Das passende Ersatz-Leuchtmittel finden Sie auf Seite 8, 12 und 16. / Vous trouverez page 8, 12 et 16 la bonne solution lumineuse. / Suitable replacement lamps please find on page 8, 12 and 16.

## LED Downlight

 	Typ	Code	EAN	Color	EEC kWh/1000h		W	lm	K
	Downlight · 3/BOX	21510004	4004894850013	white	A+ / 3	88 x 29	3	225	2700
	Downlight · 5/BOX	21510005	4004894850020	white	A+ / 3	88 x 29	3	225	2700
	Downlight · 3/BOX	21510006	4004894850037	satin	A+ / 3	88 x 29	3	225	2700
	Downlight · 5/BOX	21510007	4004894850044	satin	A+ / 3	88 x 29	3	225	2700

 **QUICK & EASY**

 Federklemme  
Pince a ressort  
Spring terminal

 ↑IP 20  
↓IP 23

 austauschbar  
remplaçable  
replaceable

 incl.  
GU10

 25°  
schwenkbar  
pivotant  
swiveling

 110°  
Abstrahlwinkel  
Angle d'éclairage  
Beam angle

 Ø 68 mm  
Deckenausschnitt  
Découpage du faux-plafond  
Installation dimension

 60 mm  
Einbautiefe  
Profondeur utile  
Mounting depth

 nicht dimmbar  
non dimmable  
not dimmable

 Schutzklasse II  
Classe de protection II  
Protection class II

25.000 h  
220-240 V

 > 100.000 x  
Schaltungen  
Cycles de commutation  
Switch cycles

Hinweise zur Energieeffizienzklasse auf Seite 92. / Les informations sur les catégories d'efficacité énergétique sont indiquées page 92. / Notes on Energy Efficiency Class on page 92.

Das passende Ersatz-Leuchtmittel finden Sie auf Seite 8, 12 und 16. / Vous trouverez page 8, 12 et 16 la bonne solution lumineuse. / Suitable replacement lamps please find on page 8, 12 and 16.

## LED Cabinet Light Plug

 	Typ	Code	EAN	Color	EEC kWh/1000h		W	lm	K
	Cabinet Light Plug 45	20900288	4004894850860	silver	A / 5	449 x 87 x 49	5	270	4000

 **ON/OFF SWITCH**

 Steckdose DE  
Socle DE  
Socket DE

 nicht dimmbar  
non dimmable  
not dimmable

 Schutzklasse I  
Classe de protection I  
Protection class I

25.000 h  
220-240 V

 nicht austauschbar  
non remplaçable  
not replaceable

Hinweise zur Energieeffizienzklasse auf Seite 92. / Les informations sur les catégories d'efficacité énergétique sont indiquées page 92. / Notes on Energy Efficiency Class on page 92.

LED Cabinet Light Swing



Typ	Code	EAN	Color	EEC kWh/1000h		W	lm	K
Cabinet Light Swing 35	20900285	4004894546893	silver	A+ / 6	347 x 85 x 35	5,5	400	3000
Cabinet Light Swing 60	20900286	4004894546909	silver	A+ / 10	575 x 85 x 35	10	800	3000

 <b>QUICK &amp; EASY</b>	 incl. 180 cm Zuleitung Cable électrique Electric cable	 <b>ON/OFF</b> <b>SWITCH</b>	 schwenkbar pivotant swiveling	 nicht dimmbar non dimmable not dimmable	 Schutzklasse II Classe de protection II Protection class II	<b>25.000 h</b> <b>230 V</b>	 nicht austauschbar non remplaçable not replaceable
--	--	---	--	---	--	---------------------------------	---

Hinweise zur Energieeffizienzklasse auf Seite 92. / Les informations sur les catégories d'efficacité énergétique sont indiquées page 92. / Notes on Energy Efficiency Class on page 92.

## VERKAUFSSTARKE KOMMUNIKATION AM POS MIT DEM NEUEN MÜLLER-LICHT KONZEPT

Die richtige Lampen- und Leuchtenwahl leicht gemacht

### Selbsterklärende Verpackungen

Auf der Vorderseite der neuen MÜLLER-LICHT Verpackungen finden Ihre Kunden ab sofort alle wichtigen Informationen auf einen Blick:

#### WIE HELL LEUCHTET DIE LAMPE

Die Helligkeit einer LED wird mit ihrer Lichtleistung (Lumen) angegeben.

#### LUMINOSITE DE LA LAMPE

Le niveau de luminosité d'un LED est défini par son rendement lumineux (en lumen).

#### HOW BRIGHT IS THE LAMP

The brightness of an LED is indicated by its light output (lumen).

#### DIMMBARKEIT

Diese Lampe ist dimmbar.

#### REGULATION

Cette lampe est dimmable.

#### DIMMING

This lamp is dimmable.

#### DIE LICHTFARBE

Schnelleinordnung zur Lichtfarbe.

#### LA COULEUR LUMINEUSE

Définition rapide de la couleur lumineuse.

#### THE LIGHT COLOR

Quick classification by light color.

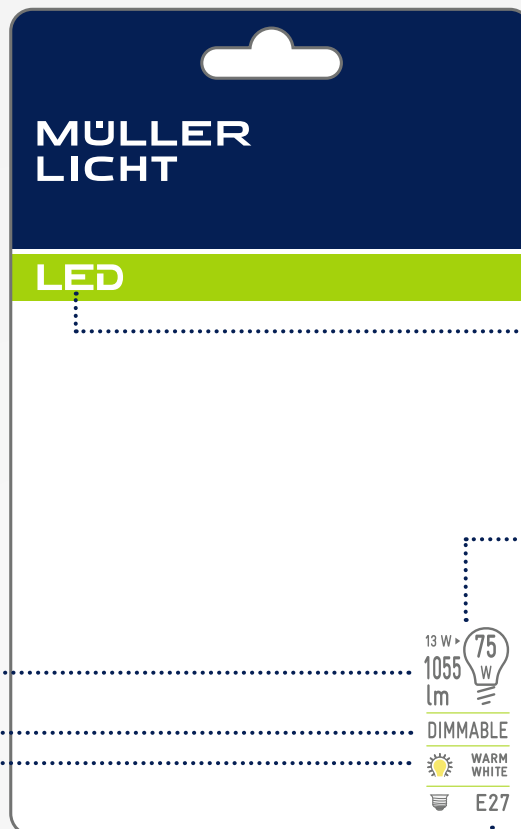

#### WELCHE TECHNIK KOMMT ZUM EINSATZ

Angabe der zugrunde liegenden Technik wie z.B. LED, Halogen, Energiespar- oder Allgebrauchslampen.

#### UTILISATION DE QUELLE TECHNIQUE

Informations sur la technique de base utilisée comme les LED, halogène, lampes polyvalente ou faible consommation.

#### WHICH TECHNOLOGY IS USED

Specification of the base technology, such as LED, halogen, energy-saving or all-purpose lamps.

#### ENERGIEVERBRAUCH

Tatsächlicher Energieverbrauch der enthaltenen LED Lampe im Vergleich zum Energieverbrauch einer vergleichbaren herkömmlichen Glühlampe.

#### CONSUMMATION EN ENERGIE

Consommation réelle en énergie des lampes LED par rapport à celle des ampoules classiques.

#### ENERGY CONSUMPTION

Actual energy consumption of the LED lamp in comparison with the energy consumption of a comparable conventional incandescent lamp.

#### ANGABEN ZUM SOCKEL

Socketarten im Überblick:

#### INFORMATIONS SUR LE SOCLE

Aperçu des types de socles:

#### SPECIFICATIONS FOR THE SOCKET

An overview of socket types:



E14 E27 GU10 G9 GU4 GU5.3 G4

**UNE COMMUNICATION EFFICACE ET PERTINENTE EN MAGASIN GRACE AU NOUVEAU CONCEPT DE MÜLLER-LICHT**

Faciliter le choix du bon éclairage et du bon modèle de lumière

Des emballages faciles à comprendre

Sur la face avant des nouveaux emballages MÜLLER-LICHT, les clients pourront voir, un en seul coup d'œil, toutes les informations importantes:

**SALES-PROMOTING COMMUNICATION AT THE POS WITH THE NEW MÜLLER-LICHT CONCEPT**

The right lamp and luminaire selection made easy

Self-explanatory packaging

Your customers can immediately find all the important information with a quick glance at the front side of the new MÜLLER-LICHT packages:

**HAUPTFEATURE**

Aufführung der wichtigsten Produkteigenschaften, die zum Kauf beitragen.

**CARACTERISTIQUES PRINCIPALES**

Présentation des principales caractéristiques du produit qui encouragent et favorisent l'achat.

**MAIN FEATURE**

Listing of the key product features that contribute to the sale.

**LEUCHTMITTELAUSTAUSCH**

Plakativer Button sofern das Leuchtmittel austauschbar ist.

**AMPOULE REMPLACABLE**

Fonction indiquant si l'ampoule est remplaçable.

**LAMP REPLACEMENT**

Striking button if the lamp is replaceable.



**EINSATZBEREICH**

Bildliche Darstellung des idealen Einsatzbereiches dieser Leuchte.

**DOMAINE D'UTILISATION**

Présentation imagée du domaine d'utilisation idéal de ces lumières.

**AREA OF APPLICATION**

Picture representing the ideal area of application of this luminaire.

**HELLIGKEIT & ENERGIEVERBRAUCH**

Angabe der Lichtleistung in Lumen und tatsächlicher Energieverbrauch in Watt.

**LUMINOSITE ET CONSOMMATION EN ENERGIE**

Informations sur le rendement lumineux en lumen et la consommation réelle en énergie en Watt.

**BRIGHTNESS & ENERGY CONSUMPTION**

Specification of the light output in lumen and actual energy consumption in watts.

**TECHNIK**

Auslobung der LED-Technik..

**TECHNIQUE**

Présentation de la technique LED.

**TECHNOLOGY**

Endorsement of LED technology.

## EINFACHE KUNDENFÜHRUNG AM REGAL

Am neuen MÜLLER-LICHT-Regal findet sich der Endverbraucher schnell und einfach zurecht:

### ORIENTATION FACILE DU CLIENT EN RAYON

Sur la nouvelle étagère MÜLLER-LICHT, le client s'y retrouvera facilement et rapidement:

### SIMPLE CUSTOMER GUIDANCE AT THE SHELF

The end consumer finds their way around quickly and easily at the new MÜLLER-LICHT shelf:

#### EINSATZBEREICH UND FARBCODIERUNG

Der Blick des Kunden wird horizontal nach Einsatzbereich der Leuchten geführt.

##### DOMAINE D'UTILISATION ET CODES COULEURS

Le regard du client sera guidé horizontalement vers les domaines d'utilisation des lumières.

##### APPLICATION AND COLOR CODES

The view of the customer is guided horizontally on the application of the luminaire.

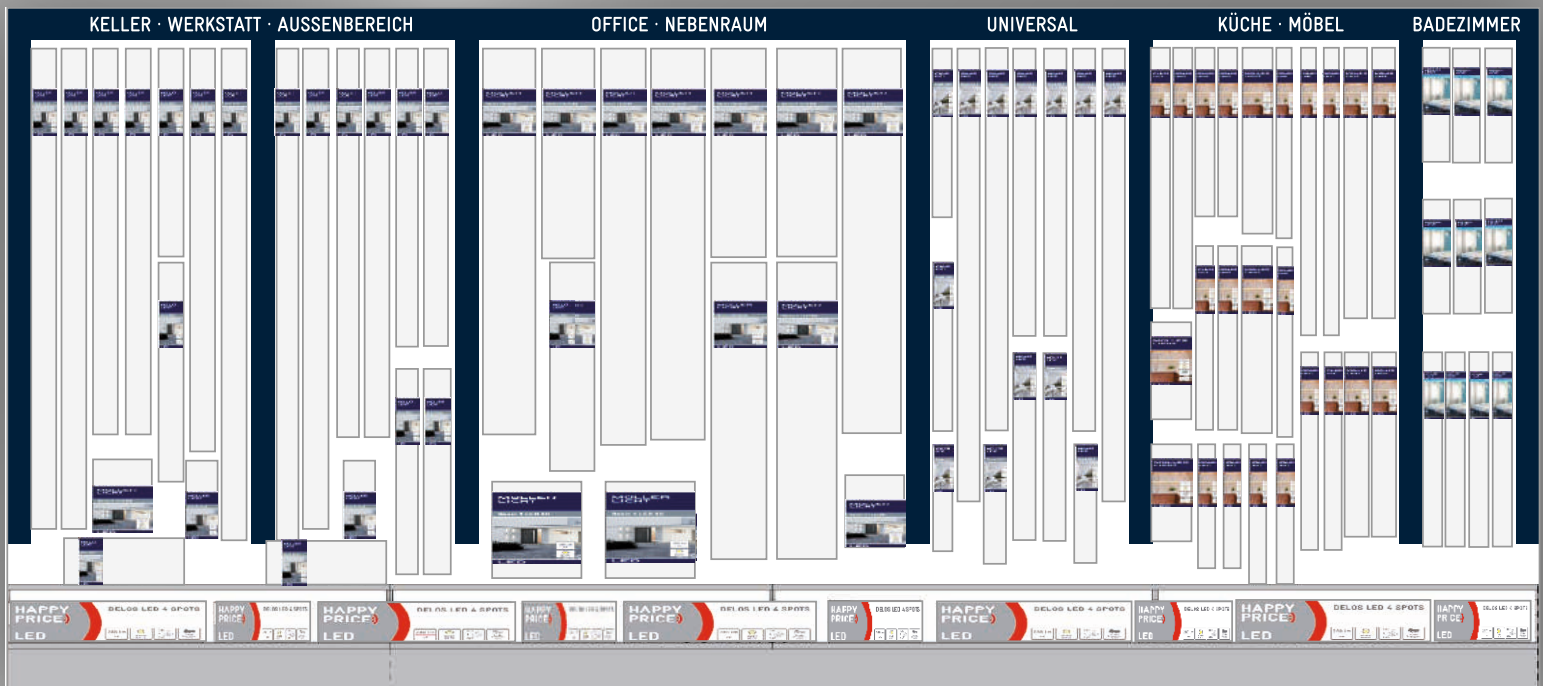

Selbstverständlich passen wir jedes Regal je nach verfügbarem Platz individuell für Sie an. Sprechen Sie uns einfach an, wir finden eine genau auf Ihre Situation zugeschnittene Lösung.

Nous adaptons bien évidemment chaque étagère à l'espace disponible. N'hésitez pas à nous contacter, nous vous proposerons la solution parfaitement adaptée à votre situation.

Naturally, we adapt each shelf individually to your available space. Simply contact us and we will provide solution tailored precisely to your situation.

### BAUFORM UND SOCKEL

Der Blick des Kunden wird horizontal nach Bauform und Sockel geführt.

### LEISTUNG / ENERGIEVERBRAUCH

Der Blick des Kunden wird vertikal nach Leistung / Energieverbrauch geführt.

#### FORME ET SOCLE

Le regard du client sera guidé horizontalement vers les formes et les socles de lumière.

#### SHAPE AND SOCKET

The view of the customer is guided horizontally on the shape and socket.

#### PUISSANCE/CONSOMMATION EN ENERGIE

Le regard du client sera guidé verticalement en fonction de la puissance/consommation en énergie.

#### POWER / ENERGY CONSUMPTION

The view of the customer is guided vertically on power / energy consumption.

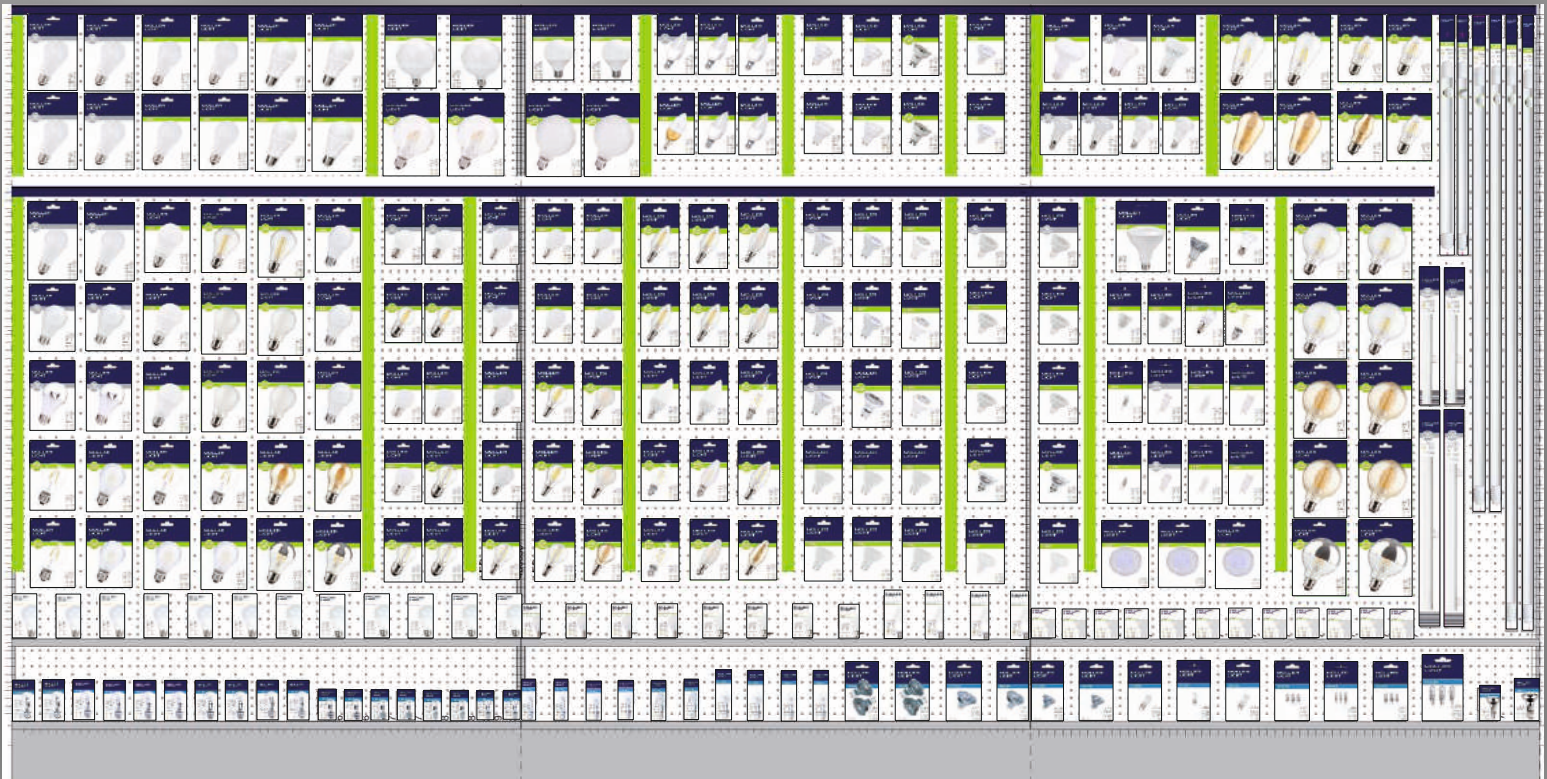

## ATTRAKTIVE ZWEITPLATZIERUNGEN

**Aufmerksamkeit beim Kunden wecken und zusätzliche Umsätze sichern.**

Mit den verkaufsstarken Displays von MÜLLER-LICHT setzen Sie Produkte wirkungsvoll ins perfekte Licht:

### PRESENTOIRS SECONDAIRES INTERESSANTS

Attirer l'attention des clients et assurer du chiffre d'affaires en plus.

Avec les affichages très attractifs de MÜLLER-LICHT, vous mettez sous les projecteurs les produits que vous proposez:

### ATTRACTIVE SECONDARY DISPLAYS

Draw the attention of your customers and provide additional sales.

With the sales-promoting displays from MÜLLER-LICHT, you effectively put the products in the ideal light:

22714 ESSENTIAL-DISPLAY

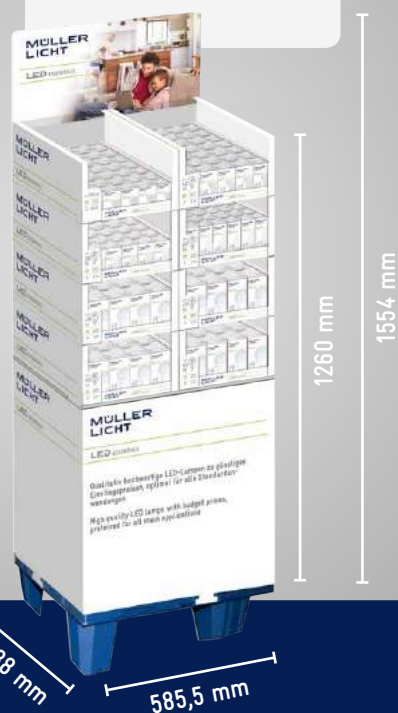

					
400170	Kerze / Flamme / Candle	E14	3	25	250
400228 <sup>1</sup>	Kerze / Flamme / Candle	E14	5,5	40	470
400169	Miniglobe / Mini-Globe / Mini Globe	E14	3	25	250
400230 <sup>1</sup>	Miniglobe / Mini-Globe / Mini Globe	E14	5,5	40	470
400167	Reflektor / Réflecteur / Reflector	GU10	3	-	230
400233 <sup>1</sup>	Reflektor / Réflecteur / Reflector	GU10	5	> 50	320
400235 <sup>1</sup>	Reflektor / Réflecteur / Reflector	GU5.3	5	> 50	320
400168	Reflektor / Réflecteur / Reflector <b>R50</b>	E14	6	40	430
400171	Birne / Ampoule / Bulb	E27	5,5	40	470
400172	Birne / Ampoule / Bulb	E27	10	60	810

<sup>1</sup> Verfügbar ab Quartal 2. / Commercialisé à partir du 2<sup>ème</sup> trimestre. / Available from quarter 2.

# ZWEITPLATZIERUNGEN

## PRESENTOIRS SECONDAIRES / SECONDARY DISPLAYS



HAPPY PRICE GONDEL  
GONDOLE HAPPY PRICE  
HAPPY PRICE GONDOLA

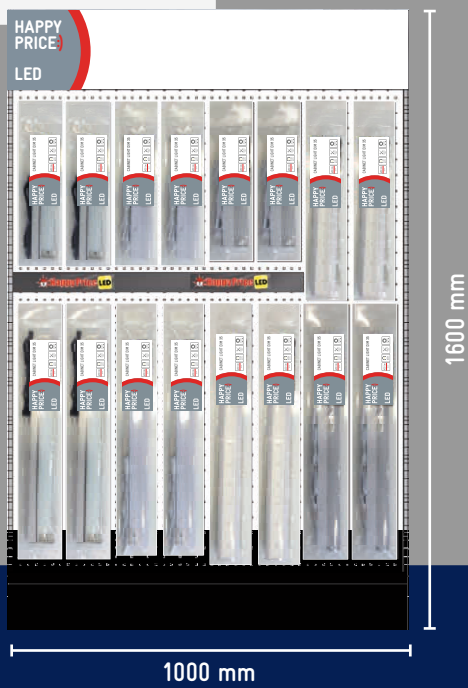

**21400616** PROMO-PALETTE  
PALETTE PROMOTIONS  
PROMO PALETT

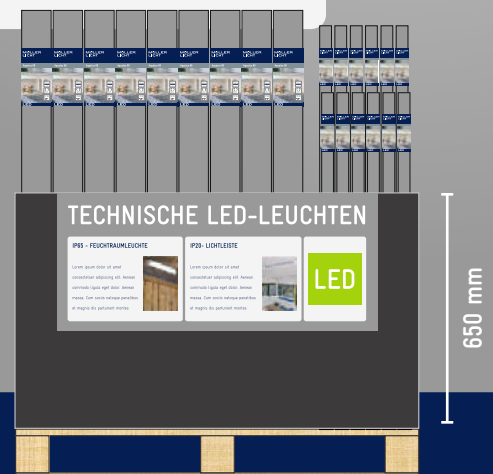

## PIKTOGRAMME TECHNISCHE DATEN

PICTOGRAMS TECHNICAL SPECIFICATIONS

PICTOGRAMMES DES DONNÉES TECHNIQUES

	Socket Socle Socket		Gehäusefarbe Couleur du boîtier Housing color
	Nennleistung (Watt W) Flux lumineux utile nominal Rated power		Energieeffizienzklasse & gew. Verbrauch Catégorie d'efficacité énergétique et consommation moyenne Energy efficiency class & weighted consumption
	Äquivalente AGL (Watt W) AGL équivalent Equivalent incandescent		Schutzklasse I Classe de protection I Protection class I
	Nenn-Nutzlichtstrom (Lumen lm) Flux lumineux nominal Rated utilised flux		Schutzklasse II Classe de protection II Protection class II
	Farbwiedergabe (>Ra) Indice de rendu des couleur Color rendering index		Schutzklasse III Classe de protection III Protection class III
	Nenn-Halbwertwinkel (Grad °) Angle de diffusion Rated half power angle		Schutzart (Schutz gegen Fremdkörper / Wasser) Type de protection (protection contre les corps étrangers/l'eau) Protection rating (protection against foreign objects / water)
	Energieeffizienzklasse (EEK) Classe énergétique Energy efficiency class (EEC)		Enthält eingebaute, nicht austauschbare LED Comporte des lampes à LED intégrées, pas remplaçable Contains built-in, not replaceable LED
	Spannung (Volt V) Tension de réseau Supply voltage		Enthält austauschbare Lampen Comprend des lampes remplaçables Contains replaceable lamps
	Farbtemperatur (Kelvin K) Température de couleur Color temperature		inklusive Leuchtmittel (mit Angabe des Typs) Avec ampoules (informations sur le type) Lamp included (with specification of the type)
	Dimmbar (ja/nein) Dimmable (oui/non) Dimmable (yes/no)		Schalzhäufigkeit Cycles de commutation Switch cycles
	Abmessungen (Millimeter mm) Dimension Sizes		Mit Schalter Avec interrupteur With switch
	Anzahl pro Box oder Blister Nombre par boîte ou Blister Quantity per box or blister		dimmbar dimmable dimmable
	VPE Unité d'emballage Package unit		nicht dimmbar non dimmable not dimmable
	Lebensdauer (Stunden h) Durée de vie Lifetime		integrierter Dimmer Gradateur intégré integrated dimmer
	Name der Leuchte Nom de luminaire Name of the luminaire		Sensor Capteur Sensor
	Artikelnummer Numéro d'article Order number		IR Sensor Capteur infrarouge Infrared sensor
	Numer des Strichcodes Numéro de code barres Barcode number		Dämmerungssensor Capteur crépusculaire Twilight sensor



Quick & Easy  
 Quick & Easy  
 Quick & Easy



Direkte Verbindung mit Netzstecker  
 Branchement direct à la prise  
 Direct connection with mains plug



Länge der mitgelieferten Zuleitung  
 Longueur du câble électrique  
 Length of provided electric cable



Länge der Zuleitung mit Netzteil  
 Longueur de la rallonge fournie avec la prise  
 Length of the accompanying supply cable with mains adapter



koppelbar  
 connectable  
 connectable



für Verbindung vorbereitet, Sollbruchstelle  
 préparé pour le branchement avec le point de rupture  
 for connection prepared by predetermined breaking point



Federklemme  
 Pince a ressort  
 Spring terminal



einfache Installation  
 Montage simple  
 easy installation



selbstklebend  
 autocollant  
 self-adhesive



Abstrahlwinkel  
 Angle de diffusion  
 Rated half power angle



Automatische Abschaltung  
 Interrupteur automatique  
 Automatic switch off



Notlichtfunktion  
 Éclairage de secours  
 Emergency lighting



Fernbedienung inklusive  
 Avec télécommande  
 Remote control included



Anzahl USB-Slots  
 Quantity of USB ports  
 Nombre de port USB



Magnethalter  
 Base magnétique  
 Magnetic hold



integrierte Steckdose  
 Socle intégré  
 Integrated socket



Anzahl & Typ mitgelieferter Batterien  
 Nombre et type de piles fournies  
 Number & type of supplied batteries



Anzahl & Typ benötigter Batterien (nicht inkl.)  
 Nombre et types des piles nécessaires (non inclus)  
 Number & type of required batteries (not incl.)



Typ des eingebauten Akkus  
 Qualification d'accumulateur  
 Type of rechargeable battery



Inklusive elektronischem Vorschaltgerät (EVG)  
 Avec ballast électronique  
 Including electronic ballast



einzeln verschiebbar  
 ajustable seul  
 individual shiftable



schwenkbar  
 pivotant  
 pivoting



Downlight starr  
 Spot rigide  
 Downlight fixed



Downlight schwenkbar  
 Spot pivotant  
 Downlight swiveling



Einbaudurchmesser / Deckenausschnitt  
 Découpage du faux-plafond  
 Installation dimension



Einbautiefe  
 Profondeur utile  
 Mounting depth

## LUMEN STATT WATT

Im Vergleich zu herkömmlichen Glühlampen benötigen LED Lampen weniger Energie zur Erzeugung der gleichen Lichtleistung. Um also die Helligkeit von verschiedenen Lampen vergleichen zu können, wird die Lichtleistung, oder Lumen (lm), angegeben.

### LUMEN AU LIEU DE WATT

En comparaison avec les ampoules traditionnelles, les lampes LED nécessitent moins d'énergie pour émettre la même quantité de lumière. Afin de pouvoir comparer la luminosité provenant de lampes différentes, il est nécessaire d'indiquer la quantité de lumière émise soit en lumen (lm).

### LUMEN INSTEAD OF WATT

Compared to traditional incandescent LED lamps require less energy for same light output. To be able to compare the brightness of different lamps, the light output or lumen (lm) is indicated.

Glühlampe	Incandescent Lamp Ampoule	LED-Lampe	LED lamp Ampoule LED
25 W	<b>220 lm</b>	→	3 W <b>250 lm</b>
40 W	<b>415 lm</b>	→	7 W <b>470 lm</b>
60 W	<b>710 lm</b>	→	10 W <b>810 lm</b>
75 W	<b>935 lm</b>	→	14 W <b>1055 lm</b>



**MÜLLER LICHT**

 Diese Leuchte enthält eingebaute LED-Lampen.

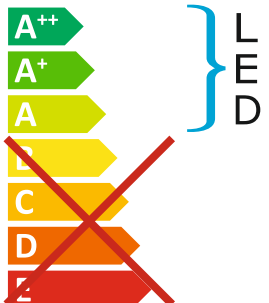

Die Lampen können in der Leuchte nicht ausgetauscht werden.

**874/2012** 

20000047	20100308	20300539	20800167	27700017	400093
20000048	20100309	20500068	20800168	27700018	400094
20000049	20100310	20500069	20800169	27700019	400095
20000050	20200171	20500070	20900275	27700020	400096
20000066	20200180	20500071	20900276	27700021	400097
20000067	20300395	20500072	20900277	27700022	400098
20000068	20300396	20500073	20900278	400072	400136
20000069	20300397	20500074	20900279	400073	400152
20000070	20300398	20500075	20900280	400074	400153
20000071	20300399	20500076	20900281	400075	400154
20000078	20300516	20500077	20900282	400076	400161
20000079	20300517	20500078	20900283	400077	400225
20000080	20300518	20500079	20900284	400078	400226
20000081	20300519	20500080	20900285	400079	
20000082	20300520	20500081	20900286	400080	
20000083	20300521	20500082	20900288	400081	
20100288	20300522	20500083	27700001	400082	
20100289	20300523	20500084	27700002	400083	
20100290	20300527	20500085	27700003	400084	
20100291	20300528	20500086	27700009	400085	
20100292	20300529	20500087	27700010	400086	
20100293	20300530	20800152	27700011	400087	
20100294	20300531	20800153	27700012	400088	
20100295	20300535	20800170	27700013	400089	
20100305	20300536	20800164	27700014	400090	
20100306	20300537	20800165	27700015	400091	
20100307	20300538	20800166	27700016	400092	

**MÜLLER LICHT**

 Diese Leuchte ist geeignet für Leuchtmittel der Energieklassen:



Die Leuchte wird verkauft mit einem Leuchtmittel der Energieklasse: **A**

**874/2012** 

20200156
20300002
20300400
20800124
20800125
20800126
20800136
20800137
20800138
20800139
20800140
20800141

Les lampes de ce luminaire ne peuvent pas être changées.

The lamps cannot be changed in the luminaire.

Le luminaire est vendu avec une ampoule de la classe énergétique: **A**

The luminaire is sold with a bulb of the energy class: **A**

**MÜLLER LICHT**

 Diese Leuchte ist geeignet für Leuchtmittel der Energieklassen:

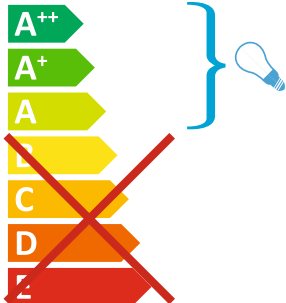

Die Leuchte wird verkauft mit einem Leuchtmittel der Energieklasse: **A+**

**874/2012** 

20100301	21520008	21530001
20100302	21520009	21530002
20300524	21520010	21530003
20300525	21520011	21530004
20300526	21520012	21530005
20800154	21520013	21530006
20800155	21520014	21530007
20800156	21520015	21530008
20800157	21520016	21530009
20800158	21520017	21530010
20800159	21520018	21530011
21510000	21520019	21530012
21510001	21520020	21530013
21510002	21520021	21530014
21510003	21520022	21530015
21510004	21520023	21530016
21510005	21520024	21530017
21510006	21520025	20300532
21510007	21520026	20300533
21520000	21520027	20300534
21520001	21520028	
21520002	21520029	
21520003	21520030	
21520004	21520031	
21520005	21520032	
21520006	21520033	
21520007	21530000	

**MÜLLER LICHT**

 Diese Leuchte ist geeignet für Leuchtmittel der Energieklassen:



Die Leuchte wird verkauft mit einem Leuchtmittel der Energieklasse: **A+**

**874/2012** 

20200162
20200164
20200165
20200167
20300401
20300402
20300403
20300404

Le luminaire est vendu avec une ampoule de la classe énergétique: **A+**

The luminaire is sold with a bulb of the energy class: **A+**

Le luminaire est vendu avec une ampoule de la classe énergétique: **A+**

The luminaire is sold with a bulb of the energy class: **A+**

## LEUCHTMITTEL &amp; ACCESSOIRES

## LAMPES &amp; ACCESSOIRES / LAMPS &amp; ACCESSORIES

Code	EAN	Code	EAN	Code	EAN	Code	EAN	Code	EAN
100000	4018412321053	300018	4018412321978	400015	4018412324320	400076	4018412326096	400157	4018412328748
100001	4018412321077	300019	4018412322005	400016	4018412324351	400080	4018412326201	400158	4018412325556
100002	4018412321091	300020	4018412322036	400017	4018412324382	400081	4018412326232	400159	4018412328793
100003	4018412321114	300022	4018412322098	400018	4018412324412	400082	4018412326263	400160	4018412329486
100004	4018412321138	300024	4018412322159	400019	4018412324443	400083	4018412326294	400161	4018412329554
100005	4018412321152	300025	4018412322180	400020	4018412324474	400084	4018412326324	400167	4018412325556
100006	4018412321176	300026	4018412322210	400021	4018412324504	400085	4018412326355	400168	4018412325952
100007	4018412321190	300027	4018412322241	400022	4018412324535	400086	4018412326386	400169	4018412324986
100008	4018412321213	300028	4018412322272	400023	4018412324566	400087	4018412326416	400170	4018412324504
100009	4018412321237	300029	4018412322302	400024	4018412324597	400088	4018412326447	400171	4018412324078
100010	4018412321251	300030	4018412322333	400025	4018412324627	400089	4018412326478	400172	4018412324351
100011	4018412321275	300031	4018412322364	400026	4018412324658	400090	4018412326508	400173	4018412330659
100012	4018412321299	300032	4018412322395	400027	4018412324689	400091	4018412326539	400174	4018412330680
100013	4018412321312	300033	4018412322425	400028	4018412324719	400092	4018412326560	400175	4018412330895
100014	4018412321336	300034	4018412322456	400029	4018412324740	400093	4018412326591	400176	4018412330925
20600079	4004894322220	300035	4018412322487	400030	4018412324771	400094	4018412326621	400177	4018412330956
20600080	4004894322237	300036	4018412322517	400031	4018412324801	400107	4018412326935	400178	4018412330987
20600081	4004894322244	300037	4018412322548	400032	4018412324832	400108	4018412326959	400179	4018412331014
20600082	4004894322251	300038	4018412322579	400035	4018412324924	400109	4018412326973	400180	4018412331045
20600083	4004894385294	300039	4018412322609	400036	4018412324955	400110	4018412326997	400181	4018412331076
20600084	4004894385300	300040	4018412322630	400037	4018412324986	400111	4018412327017	400182	4018412331106
20600147	4004894532131	300041	4018412322661	400038	4018412325013	400113	4018412327055	400183	4018412331137
27700001	4004894542260	300042	4018412322692	400039	4018412325044	400114	4018412327079	400184	4018412331168
27700002	4004894542277	300043	4018412322722	400040	4018412325075	400115	4018412327093	400185	4018412331199
27700003	4004894542284	300044	4018412322753	400041	4018412325099	400116	4018412327116	400188	4018412331281
27700009	4004894542345	300045	4018412322784	400042	4018412325112	400117	4018412327130	400189	4018412331311
27700010	4004894542352	300046	4018412322814	400043	4018412325143	400118	4018412327161	400190	4018412331342
27700011	4004894542369	300047	4018412322845	400044	4018412325174	400119	4018412327192	400192	4018412331403
27700012	4004894542376	300048	4018412322876	400045	4018412325204	400120	4018412327222	400196	4018412331526
27700013	4004894542383	300049	4018412322906	400046	4018412325235	400121	4018412327253	400197	4018412331557
27700014	4004894850846	300050	4018412322937	400047	4018412325266	400122	4018412327284	400199	4018412331618
27700015	4004894850938	300051	4018412322968	400048	4018412325297	400123	4018412327314	400202	4018412331700
27700016	4004894850945	300052	4018412322999	400049	4018412325327	400126	4018412327383	400204	4018412331762
27700017	4004894851218	300053	4018412323026	400050	4018412325358	400127	4018412327413	400206	4018412331823
27700018	4004894851225	300054	4018412323057	400051	4018412325389	400128	4018412327444	400208	4018412331885
27700019	4004894851232	300055	4018412323170	400052	4018412325419	400129	4018412327475	400210	4018412331946
27700020	4004894851249	300056	4018412323088	400053	4018412325433	400130	4018412327505	400212	4018412332004
27700021	4004894851256	300057	4018412323118	400054	4018412325464	400131	4018412327536	400214	4018412332066
27700022	4004894851317	300058	4018412323149	400055	4018412325495	400132	4018412327550	400216	4018412332127
300000	4018412321350	300064	4018412332424	400056	4018412325525	400133	4018412327581	400217	4018412332158
300001	4018412321374	300065	4018412332455	400057	4018412325556	400134	4018412327659	400218	4018412332189
300002	4018412321398	300066	4018412332486	400060	4018412325624	400135	4018412327697	400221	4018412332271
300003	4018412321411	300067	4018412332516	400061	4018412325655	400136	4018412327727	400223	4018412332363
300004	4018412321435	300068	4018412332547	400062	4018412325686	400139	4018412324351	400225	4018412332578
300005	4018412321459	400000	4018412323897	400063	4018412325716	400140	4018412324504	400226	4018412332608
300006	4018412321619	400001	4018412323927	400064	4018412325747	400141	4018412324986	400227	4018412332653
300007	4018412321640	400002	4018412323958	400065	4018412325778	400146	4018412328410	400228	4018412332653
300008	4018412321671	400004	4018412324016	400066	4018412325808	400147	4018412328441	400229	4018412332714
300009	4018412321701	400005	4018412324047	400067	4018412325839	400148	4018412328472	400230	4018412332714
300010	4018412321732	400006	4018412324078	400068	4018412325860	400149	4018412328502	400231	4018412332776
300011	4018412321763	400007	4018412324108	400069	4018412325891	400150	4018412324078	400232	4018412332776
300012	4018412321794	400008	4018412324139	400070	4018412325921	400151	4018412325013	400233	4018412332776
300013	4018412321824	400009	4018412324153	400071	4018412325952	400152	4018412328618	400234	4018412332868
300014	4018412321855	400010	4018412324177	400072	4018412325983	400153	4018412328632	400235	4018412332868
300015	4018412321886	400011	4018412324207	400073	4018412326010	400154	4018412328656		
300016	4018412321916	400013	4018412324269	400074	4018412326041	400155	4018412328700		
300017	4018412321947	400014	4018412324290	400075	4018412326072	400156	4018412328724		

## ALLGEMEINE GESCHÄFTSBEDINGUNGEN

MÜLLER-LICHT INTERNATIONAL GMBH  
Goebelstr. 61/63, 28865 Lilienthal, Germany

### Allgemeines

Diese Lieferungs- und Zahlungsbedingungen sind wesentlicher Bestandteil aller Verträge mit unseren Kunden. Entgegenstehende Einkaufsbedingungen unserer Kunden sind unwirksam, auch wenn wir ihnen nicht ausdrücklich widersprechen. Sollte ein Teil der jeweils mit unseren Kunden getroffenen vertraglichen Vereinbarungen einschließlich dieser Bedingungen unwirksam sein oder werden, so soll die Gültigkeit aller übrigen Vereinbarungen dadurch nicht berührt werden. Der unwirksame Teil der Vereinbarungen ist in einer solchen Weise umzudeuten oder durch eine solche Regelung zu ersetzen, dass ihr Zweck auf zulässigem Wege erreicht wird.

### Vertragsabschluss

Unsere Angebote sind, sofern nicht anders vereinbart, stets unverbindlich und freibleibend. Alle Verträge kommen erst mit Zugang der schriftlichen Auftragsbestätigung, spätestens mit Ausführung der Lieferung zustande. Die Berichtigung von Druckfehlern und Irrtümern bleibt vorbehalten.

### Preise

Die Preise unseres Katalogs sind Kalkulationspreise in Euro und verstehen sich unfrei, ab Lager Lilienthal, exkl. Verpackung. Preisänderungen während der Laufzeit unseres Katalogs / unserer Preisliste bleiben vorbehalten. Es kommen die am Tage der Auftragserteilung gültigen Preise zur Anrechnung.

### Lieferung

Der Mindestauftragswert beträgt 100 Euro netto. Bis 250 Euro Auftragswert erfolgt die Lieferung unfrei auf Rechnung und Gefahr des Empfängers, ab 250 Euro Auftragswert frei Haus, ausgenommen Insellieferungen, Auslandszustellungen sowie Sonderversendungen als Expressgut, Luftfracht, Schnellpaket, o.ä. Unter diesem Betrag ist die MÜLLER-LICHT International GmbH berechtigt ein zusätzliches Entgelt für Mehraufwand von 25 Euro zu berechnen. Nachlieferungen mit Restwert unter dem Mindestbestellwert werden aufgelöst oder nach Absprache mit Folgeaufträgen ausgeliefert, sofern keine anderen Vereinbarungen getroffen wurden. Im Falle höherer Gewalt, wozu auch Materialmängel, Betriebsstörungen, Streiks oder behördliche Maßnahmen jeweils auch bei unseren Vorlieferanten sowie nicht rechtzeitige und nicht richtige Selbstbelieferung gehören, sind wir berechtigt, ganz oder teilweise vom Vertrag zurückzutreten oder nach eigenem Ermessen die Lieferung um die Dauer der Behinderung hinauszuschieben. Wird dadurch die ursprünglich vereinbarte Lieferzeit um mehr als acht Wochen überschritten, so hat der Käufer das Recht, vom Vertrag zurückzutreten. Schadenersatzansprüche sind in diesem Fall beiderseitig ausgeschlossen. Transportschäden müssen sofort der Post, der Bahn oder dem Spediteur gemeldet werden.

### Zahlung

Alle Rechnungen sind innerhalb von 30 Tagen netto, jeweils dato Faktura, zahlbar, sofern keine anderen Vereinbarungen getroffen wurden. Bei Überschreitung des Zahlungstermins behalten wir uns die Berechnung von Verzugszinsen vor. Der Käufer ist nicht berechtigt, wegen eigener, streitiger Gewährleistungsansprüche den Kaufpreis zurückzuhalten oder mit nicht anerkannten oder nicht rechtskräftig festgestellten Gegenforderungen aufzurechen oder ein Zurückbehaltungsrecht geltend zu machen. Nach Vertragsabschluss bekannt werdende Umstände, die geeignet sind, Zweifel an der Kreditwürdigkeit des Käufers aufkommen zu lassen, haben sofortige Fälligkeit aller unserer ausstehenden Forderungen zur Folge. Für noch vorliegende unausgeführte Lieferungsverträge können wir Nachnahme oder Vorkasse verlangen bzw. unter Ausschluss irgendwelcher Schadenersatzansprüche gegen uns vom Vertrag zurücktreten.

### Rückgaben

Rücksendungen mangelfreier Sendungen werden von uns nicht zur Gütschrift angenommen, es sei denn, die Rücksendung erfolgt mit unserem vorherigen schriftlichen Einverständnis. Bei vereinbarten Rücksendungen mangelfreier Lieferungen berechnen wir für die Aufarbeitung der Retour eine Kostenbeteiligung. Die Rücksendung hat kostenfrei und in einwandfreiem Zustand zu erfolgen. Sonderbestellungen sind stets von der Möglichkeit der Rückgabe ausgeschlossen. Auftragsbestätigungen und Stornierungen bedürfen der Schriftform.

### Gewährleistung

**a.** Es gelten die gesetzlichen Gewährleistungsvorschriften

**b.** Erkennbare Mängel müssen unverzüglich nach Ablieferung, verborgene Mängel unverzüglich nach Entdeckung schriftlich unter genauer Angabe der Gründe gerügt werden. Die Geltendmachung jedweder Mängel ist nach Ablauf von fünf Tagen seit Empfang der Ware ausgeschlossen (Ausschlussfrist). Der bemängelte Gegenstand ist sorgfältig verpackt und kostenfrei an uns zur Überprüfung zu übersenden. Bei berechtigten und rechtzeitigen Beanstandungen erhält der Käufer nach unserer Wahl Nachbesserung, kostenlosen Warenumtausch oder eine Warengütschrift gegen Rücksendung der Ware; sind Nachbesserungen und Warenumtausch nicht möglich oder unzumutbar, kann der Käufer vom Vertrag zurücktreten oder den Kaufpreis mindern. Schadenersatzansprüche jedweder Art einschließlich solcher wegen angeblich verspäteter Lieferungen sind ausgeschlossen, es sei denn, der Schaden wäre vorsätzlich oder grob fahrlässig verursacht worden.

**c.**

Sonderbestellungen: Waren, welche von uns nicht katalogmäßig angeboten werden, gelten als Sonderbestellungen. Für sie ist jede Art der Gewährleistungshaftung ausgeschlossen, es sei denn, dass uns grobe Fahrlässigkeit oder Vorsatz zur Last gelegt werden könnte.

### Eigentumsvorbehalt

**a.**

Wir behalten uns das Eigentum an dem Liefergegenstand bis zum Eingang aller Zahlungen aus der Geschäftsverbindung mit dem Käufer vor. Der Eigentumsvorbehalt erstreckt sich auch auf den anerkannten Saldo, soweit wir Forderungen gegenüber dem Käufer in laufende Rechnung buchen (Kontokorrent-Vorbehalt).

**b.**

Bei vertragswidrigem Verhalten des Käufers, insbesondere bei Zahlungsverzug, sind wir nach angemessener Fristsetzung berechtigt, den Liefergegenstand zurückzunehmen; der Käufer ist zur Herausgabe verpflichtet. In der Zurücknahme des Liefergegenstandes durch uns liegt stets ein Rücktritt vom Vertrag. In der Pfändung des Liefergegenstandes liegt ebenfalls stets ein Rücktritt vom Vertrag. Bei Pfändungen oder sonstigen Eingriffen Dritter hat uns der Käufer unverzüglich schriftlich zu benachrichtigen, damit wir Klage gemäß § 771 ZPO erheben können. Soweit der Dritte nicht in der Lage ist, uns die gerichtlichen und außergerichtlichen Kosten einer Klage gemäß § 771 ZPO zu erstatten, haftet der Käufer für den uns entstandenen Ausfall.

**c.**

Der Käufer ist berechtigt, den Liefergegenstand im ordentlichen Geschäftsgang weiter zu verkaufen; er tritt uns jedoch bereits jetzt alle Forderungen in Höhe des Faktura-Endbetrages (einschließlich MwSt.) ab, die ihm aus der Weiterveräußerung gegen seine Abnehmer oder gegen Dritte erwachsen, und zwar unabhängig davon, ob der Liefergegenstand ohne oder nach Verarbeitung weiter verkauft worden ist. Zur Einziehung dieser Forderung ist der Käufer auch nach deren Abtretung ermächtigt. Unsere Befugnis, die Forderung selbst einzuziehen, bleibt hiervon unberührt; jedoch verpflichten wir uns, die Forderung nicht einzuziehen, solange der Käufer seinen Zahlungsverpflichtungen ordnungsgemäß nachkommt und nicht in Zahlungsverzug ist. In diesem Fall können wir verlangen, dass der Käufer uns die abgetretenen Forderungen und deren Schuldner bekannt gibt, alle zum Einzug erforderlichen Angaben macht, die dazugehörigen Unterlagen aushändigt und den Schuldnern (Dritten) die Abtretung mitteilt.

**d.**

Die Verarbeitung oder Umbildung des Liefergegenstandes durch den Käufer wird stets für uns vorgenommen. Wird der Liefergegenstand mit anderen, uns nicht gehörenden Gegenständen verarbeitet, so erwerben wir das Miteigentum an der neuen Sache im Verhältnis des Wertes des Liefergegenstandes zu den anderen verarbeiteten Gegenständen zurzeit der Verarbeitung. Für die durch Verarbeitung entstehende Sache gilt im Übrigen das Gleiche wie für die Vorbehaltsware.

**e.**

Wird der Liefergegenstand mit anderen, uns nicht gehörenden Gegenständen untrennbar verbunden oder vermischt, so erwerben wir das Miteigentum an der neuen Sache im Verhältnis des Wertes des Liefergegenstandes zu den anderen verbundenen oder vermischten Gegenständen zum Zeitpunkt der Verbindung oder Vermischung. Erfolgte die Verbindung oder Vermischung in der Weise, dass die Sache des Käufers als Hauptsache anzusehen ist, so gilt als vereinbart, dass der Käufer uns anteilmäßig Miteigentum überträgt. Der Käufer verwahrt das Alleineigentum oder das Miteigentum für uns.

**f.**

Der Käufer tritt uns auch die Forderungen zur Sicherung unserer Forderungen gegen ihn ab, die ihm durch die Verbindung des Liefergegenstandes mit einem Grundstück gegen einen Dritten erwachsen.

**g.**

Wir verpflichten uns, die uns zustehenden Sicherheiten insoweit auf Verlangen des Käufers freizugeben, als ihr Wert die zu sichernden Forderungen, soweit diese noch nicht beglichen sind, um mehr als 20% übersteigt.

### Erfüllungsort/Gerichtsstand

Erfüllungsort und Gerichtsstand sind für beide Teile Bremen.

### Datenverarbeitung

Die sich aus dem Geschäftsvorfall ergebenden Daten werden im Rahmen von Geschäftsdateien gespeichert.

Lilienthal, den 01.01.2014

# ALLGEMEINE GESCHÄFTSBEDINGUNGEN

## CONDITIONS COMMERCIALES GENERALES / GENERAL TERMS & CONDITIONS

### GENERAL TERMS & CONDITIONS

MÜLLER-LICHT INTERNATIONAL GMBH  
Goebelstr. 61/63, 28865 Lilienthal, Germany

#### General provisions

These conditions of delivery and payment are an integral part of all contracts between us and our customers. Any conflicting conditions of purchase of our customers shall be invalid even if we do not expressly object to such conditions. Should any part of the contractual agreements we conclude with our customers (including these terms and conditions) be or become invalid, the validity of all other agreements shall remain unaffected. The invalid part of the agreements shall be re-constructed or replaced by an alternative provision which serves the intended purpose in a legally permissible manner.

#### Conclusion of contract

Unless otherwise agreed, our offers are always non-binding and subject to change without notice. All contracts do not become operative until a written acknowledgement of order is received, and not later than upon the carrying out of the delivery. We reserve the right to correct typographical errors and mistakes.

#### Prices

The prices of our catalogue are cost estimates in Euro that are unpaid ex warehouse Lilienthal, exclusive of packaging. Prices are subject to change without notice during the period of validity of our catalogue and/or our price list. The actual selling prices as listed on the day of the placing of order shall be invoiced.

#### Delivery

The minimum order value is EUR 100 net. For order values below EUR 250 delivery is carriage forward for account and risk of the recipient; for order values of EUR 250 and above delivery is free of charge to address of buyer, except for deliveries to islands, deliveries abroad as well as special shipments as express consignment, air cargo, express parcel, or similar. For orders below the minimum order value the MÜLLER-LICHT International GmbH shall be entitled to charge an additional amount of EUR 25 for additional expenditure. Unless otherwise agreed, subsequent deliveries of a residual value below the minimum order value will be dissolved or delivered together with follow-up orders. In the event of force majeure, which includes defects in material, plant interruptions, strikes and acts of public authorities (including those affecting our upstream suppliers) as well as delayed and incorrect self-supply, we shall have the right to cancel the contract in whole or in part, or to use our own discretion to postpone delivery by a period of time which is equal to the period of time during which the cause of obstruction continues. In the event that this results in the originally agreed delivery time being postponed by more than eight weeks, the buyer shall have the right to cancel the contract. In that case, neither party shall be entitled to any claims for damages. Transport damages must be reported immediately to the relevant post office, railway operator or freight forwarder.

#### Payment

Unless otherwise agreed, all invoices are payable within 30 days net after date of invoice. In case a buyer fails to meet the time limit for payment we shall be entitled to charge default interest. The buyer shall not have the right to retain the purchase money on the basis of own disputed warranty claims or to set off against counter-claims that have not been acknowledged or become legally enforceable or to claim a right of retention. In the event that the contract is concluded and we become subsequently aware of circumstances that give reason to doubt the creditworthiness of the purchaser, all accounts receivable shall become due and payable with immediate effect. In respect of open purchase orders that we may have on hand, we shall be entitled to request cash on delivery or cash in advance; alternatively, we shall be entitled to cancel the contract without assuming any liability for the payment of any kind of claims for damages whatsoever.

#### Goods returned

Return shipments of consignments that are free of defects shall not be credited to customer's account, unless such return shipments are made subject to our prior written consent. For approved return shipments of defect-free consignments we shall charge a specific share of the cost to customer's account to cover rework expenditure. Return shipments must be free of charge, with the goods being returned in a flawless condition. Special purchase orders are at no time subject to return privileges. Acknowledgements of order and cancellations must be executed in writing.

#### Warranty

a. The statutory warranty regulations shall apply.

b. Any discernible defects must be reported immediately after delivery and hidden defects immediately after discovery by accurately stating the reasons for objection. The right to give notice of defects shall be excluded upon expiry of five days after receipt of the goods (term of preclusion). The item found to be defective shall be carefully packed and then returned to us free of charge for inspection. In respect of justified complaints that are made in due time, we will offer the purchaser (at our exclusive discretion) rectification of defects, free exchange of goods or credit note against return shipment of the goods; in case rectification of defects and exchange of goods is not possible or unreasonable, the purchaser may cancel the contract or reduce the purchase price. Claims for damages of all kinds, including those associated with allegedly late deliveries, are excluded unless the respective damage has resulted from intention or gross negligence.

c. Special purchase orders: Goods which are not listed in our catalogue are considered to be purchased through special purchase orders. This type of

goods is not covered by any kind of warranty liability unless we are found to be guilty of gross negligence or intent.

#### Retention of title to ownership

a. We reserve the right of ownership of the delivery item until receipt of all payments due from the business relations with the purchaser. The right of retention of title to ownership also includes the confirmed balance insofar as we book receivables due from the purchaser into account current (current account reservation).

b. In case the purchaser acts in violation of the contract, including, without limitation, default in payment, we shall be entitled to recover the delivery item upon expiry of a reasonable time limit; the purchaser shall be obliged to surrender possession. Any recovery of a delivery item by us always implies a cancellation of the contract. Any attachment of the delivery item also implies a cancellation of the contract. The purchaser shall notify us in writing without delay of any attachments or other third party interventions in order to enable us to file a suit pursuant to § 771 Code of Civil Procedure (ZPO). Insofar as a third party is unable to repay us the legal fees and out-of-court expenses associated with a suit pursuant to § 771 ZPO, the purchaser shall be liable for any loss we suffer.

c. The purchaser is entitled to resell the delivery item in the ordinary course of business; the purchaser herewith assigns to us all accounts receivable in the amount of the final invoice (including VAT) which are due from customers or third parties as a result of the resale, irrespective of whether the delivery item has been resold without or after processing. The purchaser shall continue to be entitled to collect said receivables beyond the date of the assignment thereof. Our right to collect the receivables on our own shall remain unaffected; the foregoing notwithstanding, we undertake not to collect such receivables as long as the purchaser duly fulfils its payment obligations and is not in default in payment. In the event of default we shall be entitled to instruct the purchaser to disclose the assigned accounts receivable and the associated debtors, to provide all information required for collection, to hand over the associated documentation, and to notify the debtors (third parties) of the assignment.

d. Processing or redesign of the delivery item by the purchaser is always effected on our behalf. In case the delivery item is processed in combination with other items which we do not own, we shall acquire eo-ownership of the novel item in the proportion of the value of the delivery item to the other processed items at the time of such processing. The item generated through processing is otherwise subject to the same terms and conditions as the conditional commodity.

e. In case the delivery item is inseparably linked or compounded with other items which we do not own, we shall acquire co-ownership of the novel item in the proportion of the value of the delivery item to the other linked or compounded items at the time of such linking or compounding. If such linkage or compounding is effected in such a manner that the item of the purchaser is to be considered as the principal item, it is agreed that the purchaser assigns to us eo-ownership on a pro-rata basis. The purchaser holds the sole ownership or eo-ownership in safe custody on our behalf.

f. To hedge our claims against the purchaser, the purchaser also assigns to us the accounts receivable that become due from a third party as a result of the connection of the delivery item with a plot of land.

g. We undertake to release on request of the purchaser the collateral security we are entitled to insofar as its value exceeds that of the claims to be hedged (insofar as they are yet to be settled) by more than 20%.

#### Place of performance/place of jurisdiction

Both parties agree that the place of performance and place of jurisdiction is Bremen.

#### Data processing

The data originating from the business transaction will be stored as part of business files.

Lilienthal, dated 01.01.2014

Bildnachweis  
MÜLLER-LICHT International GmbH, fotolia.com,  
istockphoto.com  
Irrtum und Änderungen vorbehalten.  
Stand 02/2016

Credit  
MÜLLER-LICHT International GmbH, fotolia.com,  
istockphoto.com  
Sauf erreur ou omission.  
Edition 02/2016

Picture credits  
MÜLLER-LICHT International GmbH, fotolia.com,  
istockphoto.com  
Errors and omissions excepted.  
Version 02/2016

**MÜLLER-LICHT International GmbH**

Goebelstraße 61/63

28865 Lilienthal/Bremen

Germany

Fon +49-4298-9370-0

Fax +49-4298-9370-555

[service@mueller-licht.de](mailto:service@mueller-licht.de)

[www.mueller-licht.de](http://www.mueller-licht.de)