

TRANSFORMÁTORY PROUDU

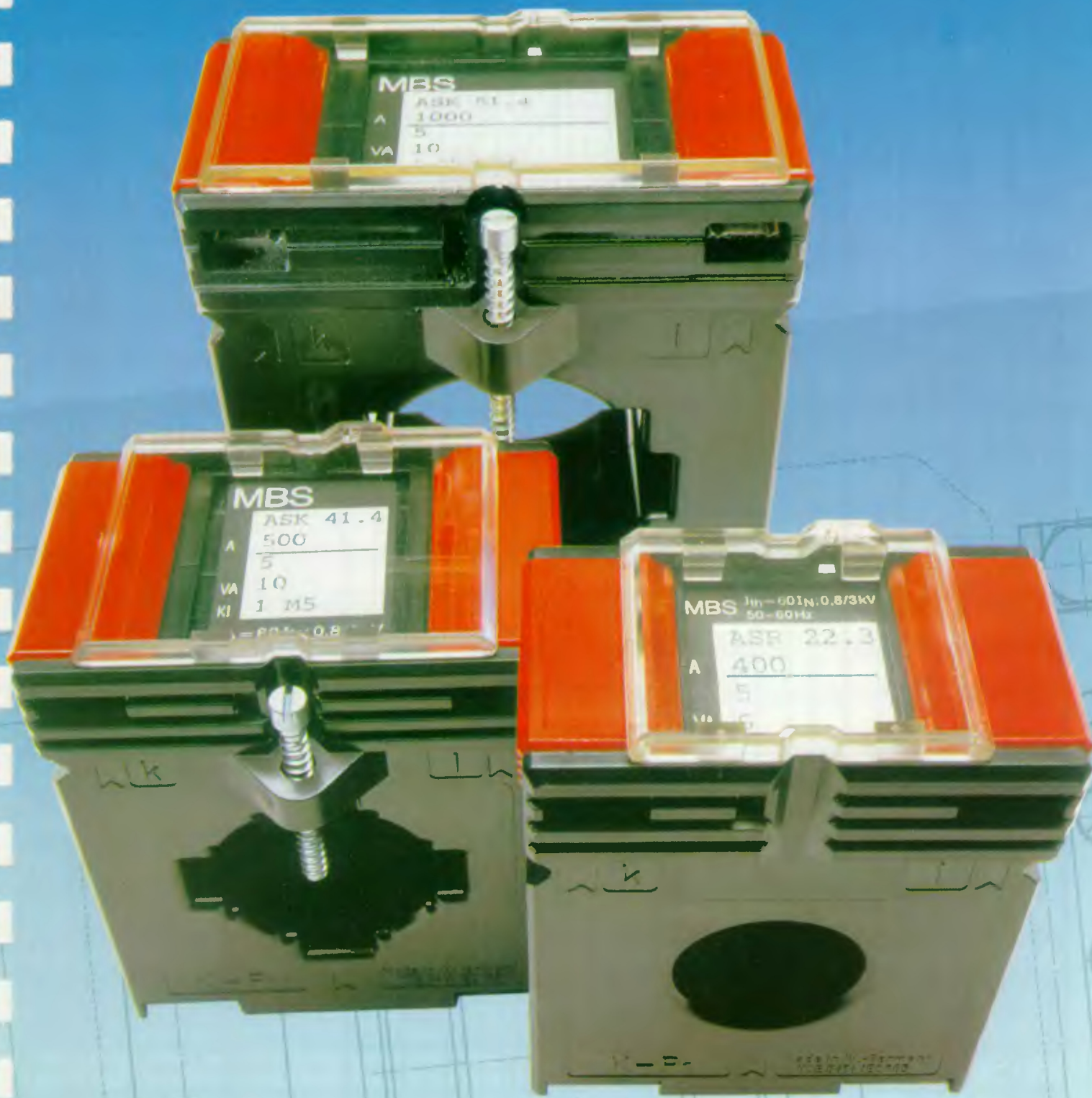

GHV TRADING s.r.o.

Kounicova 67a, 602 00 Brno
Tel.: (05) 41235386 • Fax: (05)41235387



Přehled transformátorů proudu

Primární jmenovitý proud [A]	NOVINKA		NOVINKA		NOVINKA								NOVINKA																		
	ASR 20.3	ASR 201.3	ASR 21.3	ASR 22.3	ASK 205.3	ASK 21.3	ASK 31.3	ASK 318.3	ASK 31.4	ASK 31.5	ASK 41.3	ASK 421.4	ASK 41.4	ASK 412.4	ASK 41.6	ASK 541.4	ASK 51.4	ASK 561.4													
	sekundární proud 5A nebo 1A																														
	třída přesnosti																														
0.5	1	0.5	1	1	0.5	1	1	0.5	1	1	0.5	1	0.5	1	0.5	1	1	0.5	1	0.5	1	0.5	1	0.5	1	0.5	1	0.5	1		
1																															
2.5																															
5																															
10																															
15																															
20																															
25																															
30														1														1.5			
40						1			1					1.5														2.5			
50		1		1		1.5			1.5	1			1.5	2.5				1.5	2.5		1.5	2.5				2.5		2.5			
60		1,25		1,25		1.5	1		1.5	1		1	1.5	2.5			1.5	3,75		1.5	1.5	2.5	1.5	2.5		1.5	2.5		2.5		
75		1.5		1.5		2.5	1		2.5	1.5		1.5	2.5	2.5	2.5			2.5	5		2.5	2.5	5	2.5	2.5		2.5		2.5		
80		1.5		1.5		2.5	1,25		2.5	2.5		2.5	2.5	2.5	5			2.5	5		2.5	2.5	5	2.5	5		2.5		5		
100	2,5	2,5	2,5	2,5	1	2,5	5	1,5	2,5	5	2,5	2,5	2,5	3,75	5	5	1,5	5	10	2,5	3,75	1,5	3,75	10	5	10		1,5			
125	2,5	3,75	2,5	3,75														5	10						5	10					
150	2,5	3,75	2,5	3,75	1,5	5	5	2,5	5	5	2,5	2,5	2,5	7,5	5	7,5	2,5	5	10	5	5	2,5	5	15	5	10	2,5	2,5			
200	5	5	5	5	2,5	5	10	2,5	5	10	5	5	5	10	10	15	2,5	5	15	5	10	2,5	10	15	15	15	5	5		2,5	
250	5	7,5	5	7,5	5	5	15	5	5	15	10	5	10	5	15	15	5	10	15	5	10	5	10	15	15	15	5	10		5	
300	5	7,5	5	7,5	5	5	15	5	5	15	10	5	10	10	15	15	5	10	15	10	15	5	15	15	15	15	5	10	5	5	
400					10	10	15	10	10	15	10	10	10	10	15	15	30	5	15	30	10	15	10	15	15	15	10	15	5	10	
500					10	10	15		10	15	10	10	10	10	15	15	30	10	15	30	15	15	10	15	15	15	30	10	15	5	15
600					10	10	15		10	15	15	15	15	15	15	15	30	10			15	15	10	15	30	30	30	15	15	10	15
750									10	15	15	15	15	15	15	30	15			15	15	15	30	30	30	30	10	15	10	15	
800																	15			15	30	15	30	30	30	30	15	30	15	30	
1000																			15	30				45	15	15	15	15	30	15	30
1200																												15	30	15	30
1250																											15	30	15	30	
1500																															
1600																															
1800																															
2000																															
2500																															
3000																															
4000																															
5000																															
6000																															
7500																															
8000																															
10000																															
Primární lišta [mm]						20x5	20x10	30x10	31x18	30x10	30x10	40x12	20x10	40x10	40x12	40x12	40x10	50x12	60x10												
Kulatý vodič [mm]	21	21	22.5	22.5	17.5	19.2	26	26	28	28	26	20	32	30.5	32	32	44	44													
Šířka transformátoru [mm]	44	44	48.5	60	48.5	60	60	60	60	60	60	70	70	70	95	85	85	85													

Příslušenství:

Upevňovací patky, šrouby pro upevnění na lišty a kryty typového štítku pro cejchované transformátory třídy 0,5 jsou zahrnuty v dodávce.

Upevňovací západky pro uchycení transformátoru na 35 mm DIN lišty lze dodat na přání za příplatek.

Transformátory se dodávají se zabudovanými kryty sekundárních svorek (s výjimkou ASR 201.3, ASK 41.6, ASK 61.6, ASG 41.5 a WSK 31.5)



Měřicí transformátory proudu nízkého napětí

Měřicí transformátory proudu nízkého napětí firmy MBS Sulzbach Messwandler GmbH jsou určeny k použití v rozvodných zařízeních nízkého napětí se jmenovitými proudy do 10 000 A. Transformátory splňují požadavky ČSN 351360, zahraničních norem a mezinárodních doporučení VDE 0414/1-3, DIN 42600, IEC 185 a předpisu VBG4.

Výrobní sortiment firmy MBS zahrnuje úplný soubor provedení měřicích transformátorů proudu:

WSK	závitové provedení s přípojovacím praporcem pro primární proudy 1 – 150 A
ASR	násuvné provedení s kruhovým otvorem pro primární proudy 40 – 600 A
ASK	násuvné provedení pro primární proudy 30 – 10 000 A
KSU, SUSK	sčítací transformátory pro připojení 2 – 8 primárních obvodů
NH	zvláštní provedení pro kontaktní měření na nízkonapěťových výkonových pojistkách

Standardní hodnoty jmenovitého sekundárního proudu transformátorů jsou 5 A nebo 1 A. Třídy přesnosti 0,5 a 1 (na vyžádání 0,2) jsou určeny pro obvody měření. Dále lze dodat i transformátory ve třídě přesnosti 5P a 10P pro obvody jistění. Transformátory mají nadproudové číslo ≤ 5 resp. < 10 .

Transformátory jsou zapouzdřeny v plastovém krytu z černého samozhášecího makrolonu, svařeného ultrazvukem. Použitý materiál odpovídá tepelné třídě E.

Sekundární svorky jsou osazeny dvěma poniklovanými kombinovanými šrouby M5 x 10 pro připojení vnějších obvodů a vybavené integrovanými krytkami. Transformátory třídy přesnosti 0,5 jsou standardně dodávány včetně plastových krytů umožňujících sekundární svorky zaplombovat.

K uchycení transformátoru se standardně dodávají upevňovací patky a šrouby pro upevnění na proudovou sběrnici. Transformátory proudu typu ASR 21.3, ASR 22.3, ASK 205.3, ASK 21.3, ASK 31.3, ASK 318.3, ASK 31.4, ASK 41.3, ASK 41.4 a ASK 412.4 mohou být na vyžádání dodávány s upevňovací západkou pro uchycení transformátoru na normalizovanou lištu DIN – 35 mm.

Technické parametry

Jmenovitý primární proud I_{1N}	1 – 10 000 A
Jmenovitý sekundární proud I_{2N}	5 A nebo 1 A
Třídy přesnosti	standardně 0,5 a 1 (dle požadavků 0,2; 5P; 10P)
Jmenovitý výkon	1 – 45 VA
Jmenovitý krátkodobý proud I_{thn}	$60 \times I_{1N}$ (1 s)
Jmenovitý dynamický proud I_{dyn}	$2,5 \times I_{thn}$ (závitové provedení) 100 kA (násuvné provedení)
Maximální provozní napětí	720 V
Zkušební napětí	3 kV
Jmenovitá frekvence	50 – 60 Hz (na vyžádání 16 2/3 a 400 Hz)
Zvláštní provedení (na vyžádání)	tropické pro zvýšené mechanické namáhání

Měřicí transformátory typové řady ASK a WSK jsou schváleny pro měření a účtování spotřeby elektrické energie Českým meteorologickým institutem pod čísly TCS 212/92-1397 a TCM 212/94-1815 a je možno je dodávat oceňované a na vyžádání včetně atestu.



Transformátory proudu s kruhovou dutinou ASR 20.3

Novinka

Kulatý vodič
Šířka transformátoru

21,0 mm ϕ
44 mm

Primární jmenovitý proud A	Jmenovitý výkon VA	Třída 0,5	Třída 1
		Sekundár 5A Kč	Sekundár 5A Kč
50	1		330,-
60	1		330,-
	1,25		330,-
75	1,25		330,-
	1,5		330,-
80	1,25		330,-
	2,5		330,-
100	1,5	490,-	330,-
	2,5	500,-	330,-
125	1,5	495,-	330,-
	2,5	520,-	330,-
	3,75		330,-
150	1,5	495,-	330,-
	2,5	520,-	330,-
	3,75		330,-
200	1,5	475,-	330,-
	2,5	490,-	330,-
	5	500,-	330,-
250	2,5	480,-	330,-
	5	495,-	330,-
	7,5		330,-
300	2,5	475,-	330,-
	5	500,-	330,-
	7,5		330,-

Příplatek: sekundár 1 A – 60

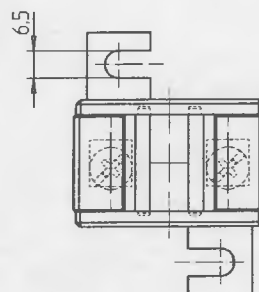
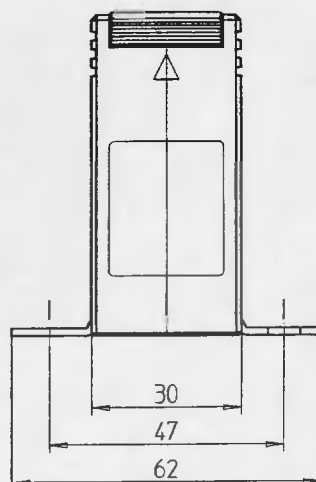
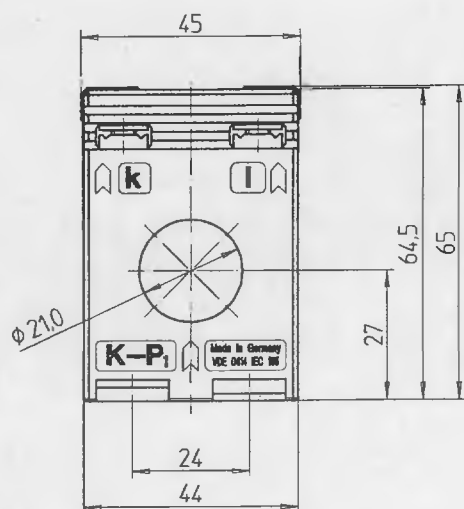



Transformátory proudu s kruhovou dutinou ASR 201.3

Novinka

Kulatý vodič 21,0 mm ϕ
Šířka transformátoru 44 mm

Primární jmenovitý proud A	Jmenovitý výkon VA	Třída 0,5	Třída 1
		Sekundár 5A Kč	Sekundár 5A Kč
50	1		345,-
60	1		345,-
	1,25		345,-
75	1,25		345,-
	1,5		345,-
80	1,25		345,-
	1,5		345,-
100	1,5	480,-	345,-
	2,5	495,-	345,-
125	1,5	490,-	345,-
	2,5	510,-	345,-
	3,75		345,-
150	1,5	490,-	345,-
	2,5	510,-	345,-
	3,75		345,-
200	1,5	465,-	345,-
	2,5	480,-	345,-
	5	495,-	345,-
250	2,5	490,-	345,-
	5	490,-	345,-
	7,5		345,-
300	2,5	465,-	345,-
	5	480,-	345,-
	7,5		345,-

Příplatek: sekundár 1 A – 60

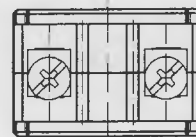
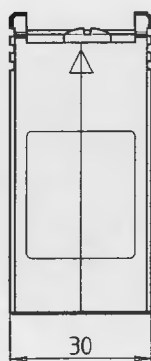
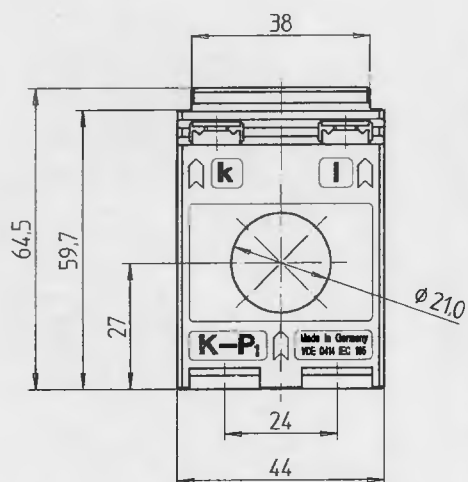



Transformátory proudu s kruhovou dutinou ASR 21.3

Kulatý vodič 22,5 mm ϕ
Šířka transformátoru 48,5 mm

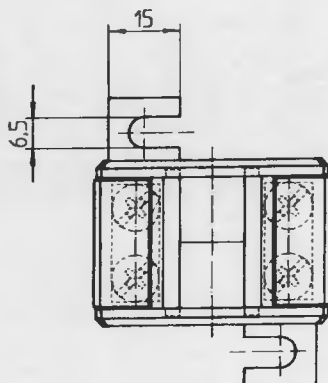
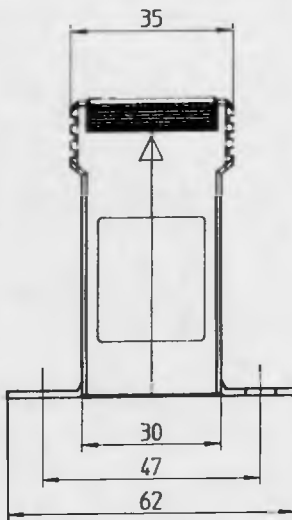
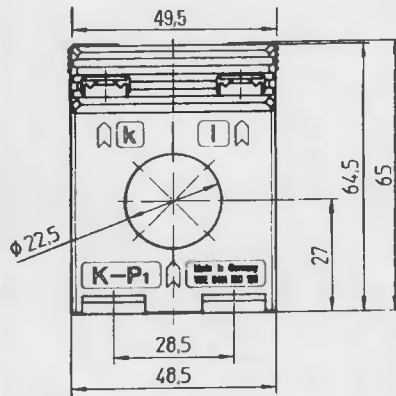

Primární jmenovitý proud A	Jmenovitý výkon VA	Třída 1	
		Sekundár 5A Kč	Sekundár 1A Kč
100	1	410,-	470,-
150	1,5	410,-	470,-
200	1,5	410,-	470,-
	2,5	410,-	470,-
250	1,5	410,-	470,-
	2,5	410,-	470,-
	5	410,-	470,-
300	1,5	410,-	470,-
	2,5	410,-	470,-
	5	410,-	470,-
400	2,5	410,-	470,-
	5	410,-	470,-
	10	410,-	470,-
500	2,5	410,-	470,-
	5	410,-	470,-
600	10	410,-	470,-
	2,5	410,-	470,-
	5	410,-	470,-

Transformátory proudu s kruhovou dutinou ASR 22.3 ASR 22.3 2U

Kulatý vodič 22,5 mm ϕ
Šířka transformátoru 60 mm



Primární jmenovitý proud A	Jmenovitý výkon VA	Třída 0,5	Třída 1
		Sekundár 5A Kč	Sekundár 5A Kč
40	1		360,-
50	1		360,-
	1,5		360,-
60	1		360,-
	1,5		360,-
75	1,5		360,-
	2,5		360,-
80	1,5		360,-
	2,5		360,-
100	1,5	790,-	360,-
	2,5	865,-	360,-
	5		360,-
150	1,5	790,-	360,-
	2,5	865,-	360,-
	5	1010,-	360,-
200	1,5	715,-	
	2,5	790,-	360,-
	5	865,-	360,-
	10		360,-
250	1,5	675,-	
	2,5	715,-	360,-
	5	790,-	360,-
	10		360,-
	15		360,-
300	2,5	640,-	360,-
	5	715,-	360,-
	10		360,-
	15		360,-
400	2,5	640,-	360,-
	5	715,-	360,-
	10	790,-	360,-
	15		360,-
500	2,5	565,-	360,-
	5	640,-	360,-
	10	715,-	360,-
	15		360,-
600	2,5	565,-	360,-
	5	640,-	360,-
	10	715,-	360,-
	15		360,-

Příplatek: sekundár 1 A – 60

ASR 22.3 2U
Přepínatelné
sekundární vinutí

Primární jmenovitý proud A	Jmenovitý výkon VA	Třída 1	
		Sekundár 5A Kč	Sekundár 1A Kč
200-100	5-2,5	450,-	510,-
300-150	5-2,5	450,-	510,-
	10-5	450,-	510,-
400-200	5-2,5	450,-	510,-
	10-5	450,-	510,-
500-250	5-2,5	450,-	510,-
	10-5	450,-	510,-
600-300	5-2,5	450,-	510,-
	10-5	450,-	510,-

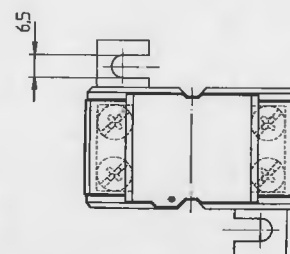
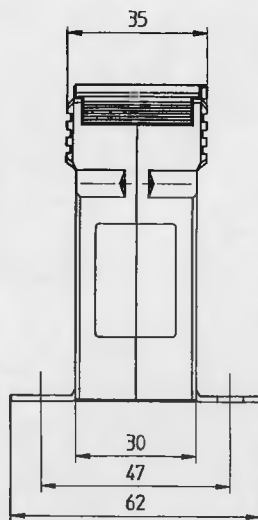
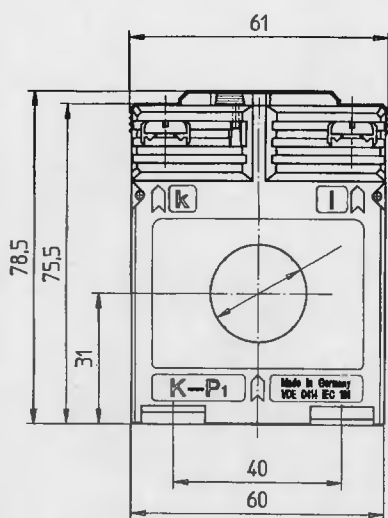



Násuvné transformátory proudu ASK 205.3

Primární lišta 20x5 mm
Kulatý vodič 17,5 mm ϕ
Šířka transformátoru 48,5 mm

Primární jmenovitý proud A	Jmenovitý výkon VA	Třída 1	
		Sekundár 5A Kč	Sekundár 1A Kč
60	1	410,-	470,-
75	1	410,-	470,-
80	1,25	410,-	470,-
100	1,25	410,-	470,-
	1,5	410,-	470,-
150	1,5	410,-	470,-
	2,5	410,-	470,-
200	1,5	410,-	470,-
	2,5	410,-	470,-
250	2,5	410,-	470,-
	5	410,-	470,-
300	2,5	410,-	470,-
	5	410,-	470,-
400	2,5	410,-	470,-
	5	410,-	470,-
	10	410,-	470,-

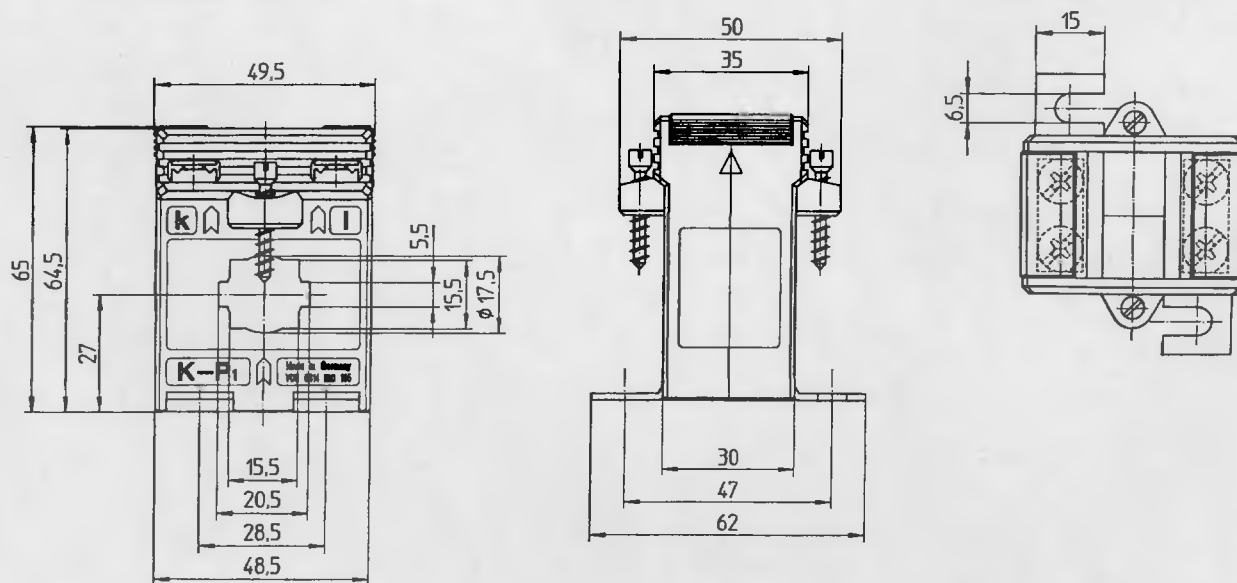

Násuvné transformátory proudu ASK 21.3

Primární lišta 20x10 mm
Kulatý vodič 19,2 mm ϕ
Šířka transformátoru 60 mm

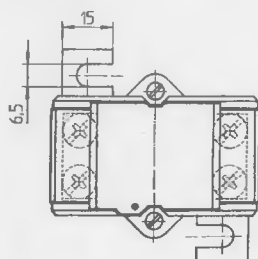
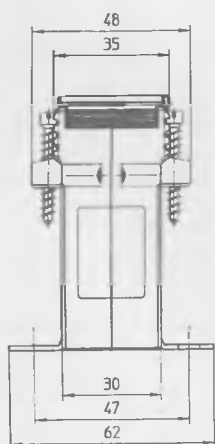
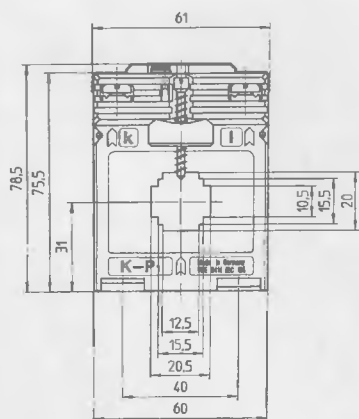

Primární jmenovitý proud A	Jmenovitý výkon VA	Třída 0,5	Třída 1
		Sekundár 5A Kč	Sekundár 5A Kč
40	1		410,-
50	1		410,-
	1,5		410,-
60	1		410,-
	1,5		410,-
75	1,5		410,-
	2,5		410,-
80	1,5		410,-
	2,5		410,-
100	1,5	790,-	410,-
	2,5	865,-	410,-
	5		410,-
150	1,5	790,-	410,-
	2,5	865,-	410,-
	5	1015,-	410,-
200	1,5	715,-	
	2,5	790,-	410,-
	5	865,-	410,-
	10		410,-
250	1,5	680,-	
	2,5	715,-	410,-
	5	790,-	410,-
	10		410,-
300	15		410,-
	2,5	640,-	410,-
	5	715,-	410,-
400	10		410,-
	15		410,-
	2,5	640,-	410,-
500	5	715,-	410,-
	10	790,-	410,-
	15		410,-
	2,5	565,-	410,-
600	5	640,-	410,-
	10	715,-	410,-
	15		410,-
	2,5	565,-	410,-

Příplatek: sekundár 1 A – 60

Násuvné transformátory proudu

ASK 31.3

Primární lišta

30x10 mm

ASK 31.3 2U

2x20x10 mm

Kulatý vodič

26,0 mm ϕ

Šířka transformátoru

60 mm



Primární jmenovitý proud A	Jmenovitý výkon VA	Třída I	
		Sekundár 5A Kč	Sekundár 1A Kč
50	1	360,-	420,-
60	1	360,-	420,-
75	1	360,-	420,-
	1,5	360,-	420,-
80	1,5	360,-	420,-
	2,5	360,-	420,-
100	1,5	360,-	420,-
	2,5	360,-	420,-
150	1,5	360,-	420,-
	2,5	360,-	420,-
200	1,5	360,-	420,-
	2,5	360,-	420,-
	5	360,-	420,-
250	1,5	360,-	420,-
	2,5	360,-	420,-
	5	360,-	420,-
	10	360,-	420,-
300	1,5	360,-	420,-
	2,5	360,-	420,-
	5	360,-	420,-
	10	360,-	420,-
400	1,5	360,-	420,-
	2,5	360,-	420,-
	5	360,-	420,-
	10	360,-	420,-
500	2,5	360,-	420,-
	5	360,-	420,-
	10	360,-	420,-
600	2,5	360,-	420,-
	5	360,-	420,-
	10	360,-	420,-
	15	360,-	420,-
750	2,5	360,-	420,-
	5	360,-	420,-
	10	360,-	420,-

Násuvné transformátory proudu ASK 318.3



Novinka

Primární lišta 31x18 mm
Kulatý vodič 26,0 mm ϕ
Šířka transformátoru 60 mm

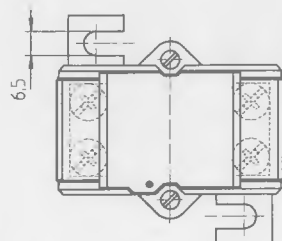
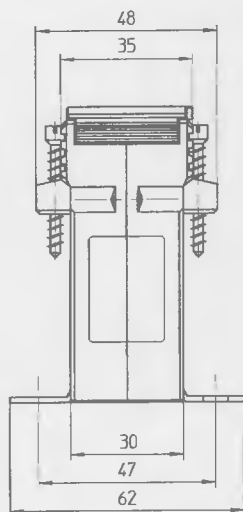
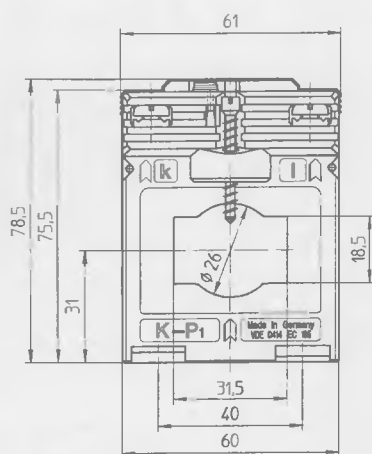

Primární jmenovitý proud A	Jmenovitý výkon VA	Třída 0,5	Třída 1
		Sekundár 5A Kč	Sekundár 5A Kč
60	1		345,-
75	1		345,-
	1,5		345,-
80	1,5		345,-
	2,5		345,-
100	1,5	660,-	345,-
	2,5	735,-	345,-
150	1,5	565,-	345,-
	2,5	625,-	345,-
200	2,5	585,-	345,-
	5	735,-	345,-
250	2,5	585,-	345,-
	5	660,-	345,-
	10		345,-
300	2,5	565,-	345,-
	5	585,-	345,-
	10		345,-
400	2,5	535,-	345,-
	5	550,-	345,-
	10	585,-	345,-
500	2,5	525,-	345,-
	5	535,-	345,-
	10	550,-	345,-
600	2,5	495,-	345,-
	5	525,-	345,-
	10	555,-	345,-
	15	585,-	345,-
750	2,5	510,-	345,-
	5	540,-	345,-
	10	570,-	345,-
	15	600,-	345,-

Příplatek: sekundár 1 A – 60





Násuvné transformátory proudu

ASK 31.4

Primární lišta

30x10 mm

ASK 31.4 2U

2x20x10 mm

ASK 31.4 3U

Kulatý vodič

28,0 mm ϕ

Šířka transformátoru

60 mm

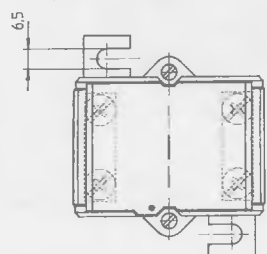
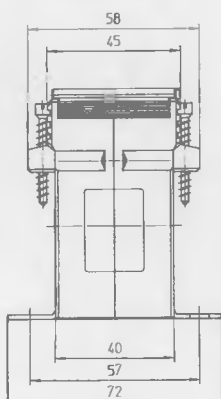
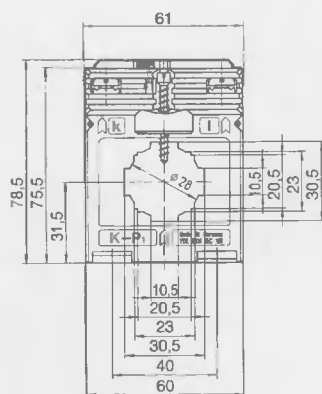

Primární jmenovitý proud A	Jmenovitý výkon VA	Třída 0,5	Třída 1
		Sekundár 5A Kč	Sekundár 5A Kč
50	1,25		390,-
	1,5		390,-
60	1,25		390,-
	1,5		390,-
75	1,5		390,-
	2,5		390,-
80	1,5		390,-
	2,5		390,-
100	1,5	715,-	390,-
	2,5	790,-	390,-
	3,75		390,-
150	1,5	640,-	390,-
	2,5	715,-	390,-
	5		390,-
	7,5		390,-
200	2,5	565,-	390,-
	5	600,-	390,-
	10		390,-
250	2,5	525,-	390,-
	5	565,-	390,-
	10		390,-
	15		390,-
300	2,5	510,-	390,-
	5	555,-	390,-
	10	715,-	390,-
	15		390,-
400	2,5	510,-	390,-
	5	525,-	390,-
	10	685,-	390,-
500	15		390,-
	2,5	510,-	390,-
	5	525,-	390,-
	10	550,-	390,-
600	15		390,-
	2,5	510,-	390,-
	5	525,-	390,-
	10	540,-	390,-
750	15		390,-
	2,5	450,-	390,-
	5	475,-	390,-
	10	505,-	390,-
	15	555,-	390,-

Příplatek: sekundár 1 A – 60

ASK 31.4 2U
Přepínatelné
sekundární vinutí

Primární jmenovitý proud A	Jmenovitý výkon VA	Třída 1	
		Sekundár 5A	Sekundár 1A
		Kč	Kč
200-100	5-2,5	450,-	510,-
300-150	5-2,5	450,-	510,-
400-200	5-2,5	450,-	510,-
	10-5	450,-	510,-
500-250	5-2,5	450,-	510,-
	10-5	450,-	510,-
600-300	5-2,5	450,-	510,-
	10-5	450,-	510,-

ASK 31.4 3U
Přepínatelné
sekundární vinutí

Primární jmenovitý proud A	Jmenovitý výkon VA	Třída 1	
		Sekundár 5A	Sekundár 1A
		Kč	Kč
300-200-100	10-5-2,5	520,-	580,-
400-200-100	10-5-2,5	520,-	580,-
600-300-150	10-5-2,5	520,-	580,-
	15-10-5	520,-	580,-
600-400-200	10-5-2,5	520,-	580,-
	15-10-5	520,-	580,-



Násuvné transformátory proudu

ASK 31.5

Primární lišta

30x10 mm

ASK 31.5 2U

2x20x10 mm

Kulatý vodič

28,0 mm ϕ

Šířka transformátoru

60 mm

Primární jmenovitý proud A	Jmenovitý výkon VA	Třída 0,5	Třída 1
		Sekundár 5A Kč	Sekundár 5A Kč
40	1		510,-
	1,5		510,-
50	2,5		510,-
	1,5		510,-
60	2,5		510,-
	1,5	925,-	510,-
75	2,5	940,-	510,-
	1,5	925,-	510,-
80	2,5	940,-	510,-
	5		510,-
	1,5	715,-	510,-
100	2,5	790,-	510,-
	5	940,-	510,-
	2,5	715,-	510,-
150	5	790,-	510,-
	7,5		510,-
	2,5	715,-	510,-
200	5	790,-	510,-
	10	865,-	510,-
	15		510,-
	5	715,-	510,-
250	10	790,-	510,-
	15	865,-	510,-
	5	675,-	510,-
300	10	735,-	510,-
	15	780,-	510,-
	5	675,-	510,-
400	10	735,-	510,-
	15	780,-	510,-
	30		510,-
	5	640,-	510,-
500	10	675,-	510,-
	15	735,-	510,-
	30		510,-
	5	565,-	510,-
600	10	600,-	510,-
	15	675,-	510,-
	30		510,-
	5	565,-	510,-
750	10	600,-	510,-
	15	675,-	510,-
	30		510,-
	5	565,-	510,-

Příplatek: sekundár 1 A – 90

ASK 31.5 2U
Přepínatelné
sekundární vinutí

Primární jmenovitý proud A	Jmenovitý výkon VA	Třída 1	
		Sekundár 5A	Sekundár 1A
		Kč	Kč
150-75	5-2,5	595,-	670,-
200-100	5-2,5	595,-	670,-
	10-5	595,-	670,-
300-150	5-2,5	595,-	670,-
	10-5	595,-	670,-
	15-7,5	595,-	670,-
400-200	5-2,5	595,-	670,-
	10-5	595,-	670,-
	15-7,5	595,-	670,-
500-250	5-2,5	595,-	670,-
	10-5	595,-	670,-
	15-7,5	595,-	670,-
600-300	5-2,5	595,-	670,-
	10-5	595,-	670,-
	15-7,5	595,-	670,-

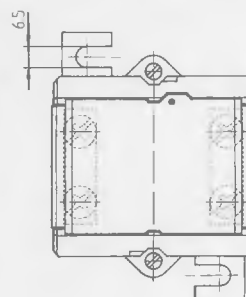
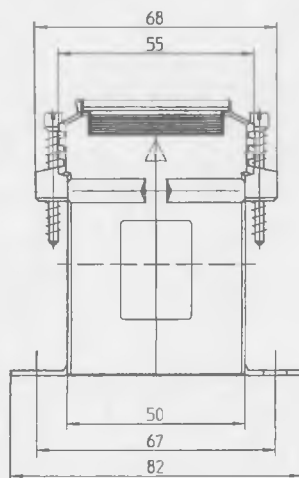
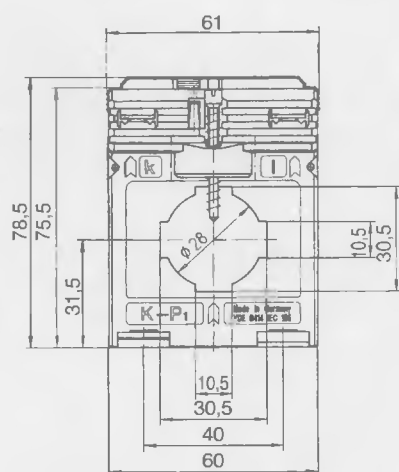

Násuvný transformátory proudu

ASK 41.3

Primární lišta

40x12 mm

30x18 mm

Kulatý vodič

26,0 mm ϕ

Šířka transformátoru

60 mm

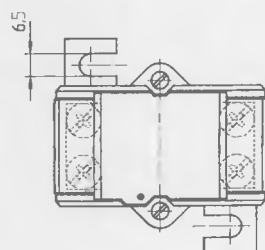
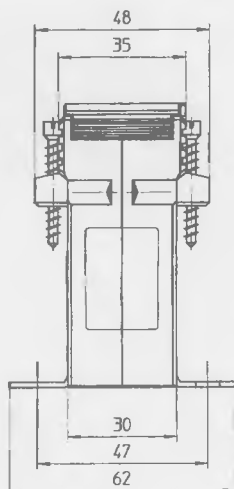
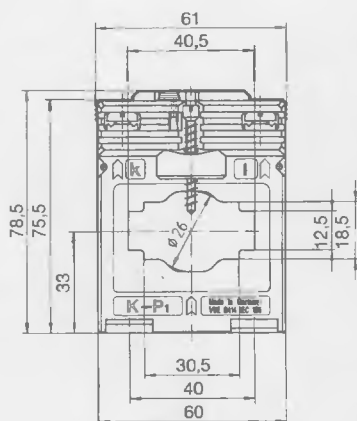

Primární jmenovitý proud A	Jmenovitý výkon VA	Třída 1	
		Sekundár 5A Kč	Sekundár 1A Kč
100	1	395,-	465,-
	1,5	395,-	465,-
150	1,5	395,-	465,-
	2,5	395,-	465,-
200	1,5	395,-	465,-
	2,5	395,-	465,-
250	1,5	395,-	465,-
	2,5	395,-	465,-
	5	395,-	465,-
300	1,5	395,-	465,-
	2,5	395,-	465,-
	5	395,-	465,-
400	1,5	395,-	
	2,5	395,-	
	5	395,-	
500	1,5	395,-	
	2,5	395,-	
	5	395,-	
	10	395,-	
600	1,5	395,-	
	2,5	395,-	
	5	395,-	
	10	395,-	
750	2,5	395,-	
	5	395,-	
	10	395,-	
	15	395,-	
800	2,5	395,-	
	5	395,-	
	10	395,-	
	15	395,-	



Násuvné transformátory proudu ASK 421.4

Primární lišta 20x10 mm
Kulatý vodič 20,0 mm ϕ
Šířka transformátoru 70 mm

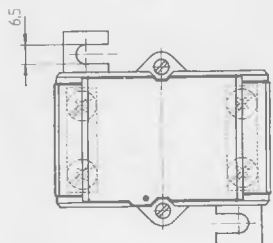
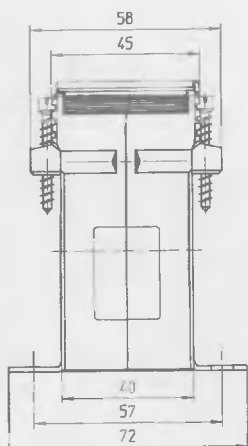
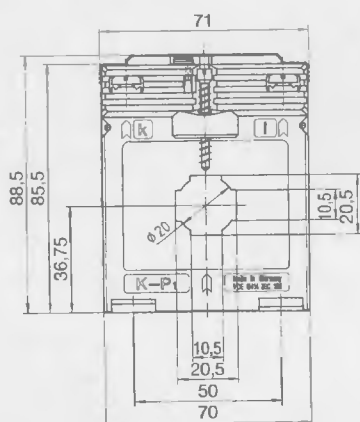

Primární jmenovitý proud A	Jmenovitý výkon VA	Třída 0,5	Třída 1
		Sekundár 5A Kč	Sekundár 5A Kč
30	1		550,-
40	1,5		550,-
50	1,5	900,-	550,-
	2,5		550,-
60	1,5	900,-	550,-
	2,5		550,-
	3,75		550,-
75	2,5	825,-	550,-
	5		550,-
80	2,5	825,-	550,-
	5		550,-
100	2,5	715,-	550,-
	5	940,-	550,-
	10		550,-
125	2,5	715,-	550,-
	5	940,-	550,-
	10		550,-
150	2,5	600,-	
	5	640,-	550,-
	10		550,-
200	2,5	565,-	
	5	640,-	550,-
	10		550,-
	15		550,-
250	5	640,-	550,-
	10	790,-	550,-
	15		550,-
300	5	540,-	550,-
	10	615,-	550,-
	15		550,-
400	5	540,-	
	10	600,-	550,-
	15	640,-	550,-
	30		550,-
500	5	540,-	
	10	600,-	550,-
	15	640,-	550,-
	30		550,-

Příplatek: sekundár 1 A – 120 Kč

Násuvné transformátory proudu

ASK 41.4

Primární lišta

40x10 mm

ASK 41.4 2U

2x30x5 mm

ASK 41.4 3U

Kulatý vodič

32,0 mm ϕ

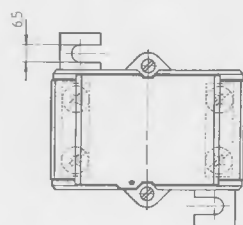
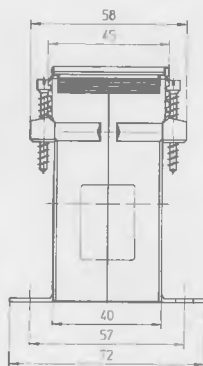
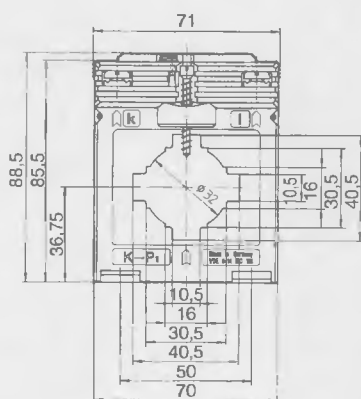

Primární jmenovitý proud A	Jmenovitý výkon VA	Třída 0,5	Třída 1
		Sekundár 5A Kč	Sekundár 5A Kč
50	1,25		410,-
	1,5		410,-
60	1,25		410,-
	1,5		410,-
75	1,5		410,-
	2,5		410,-
80	1,5		410,-
	2,5		410,-
100	1,5	660,-	410,-
	2,5	735,-	410,-
	3,75		410,-
150	1,5	565,-	410,-
	2,5	625,-	410,-
	5	735,-	410,-
200	1,5	535,-	
	2,5	590,-	410,-
	5	735,-	410,-
	10		410,-
250	1,5	535,-	
	2,5	585,-	410,-
	5	660,-	410,-
	10		410,-
300	2,5	565,-	410,-
	5	585,-	410,-
	10	645,-	410,-
	15		410,-
400	2,5	535,-	410,-
	5	550,-	410,-
	10	585,-	410,-
500	15		410,-
	2,5	525,-	410,-
	5	550,-	410,-
	10	625,-	410,-
600	15		410,-
	2,5	495,-	410,-
	5	525,-	410,-
	10	555,-	410,-
750	15		410,-
	2,5	585,-	410,-
	5	525,-	410,-
750	10	555,-	410,-
	15	570,-	410,-
	15		410,-

Násuvné transformátory proudu

ASK 41.4

Primární lišta

40x10 mm

ASK 41.4 2U

2x30x5 mm

ASK 41.4 3U

Kulatý vodič

32,0 mm ϕ

Šířka transformátoru

70 mm

Primární jmenovitý proud A	Jmenovitý výkon VA	Třída 0,5	Třída 1
		Sekundár 5A	Sekundár 5A
		Kč	Kč
800	5	525,-	410,-
	10	555,-	410,-
	15	570,-	410,-
	30		410,-
1000	5	525,-	410,-
	10	600,-	410,-
	15	640,-	410,-
	30		410,-

Příplatek: sekundár 1 A – 90

ASK 41.4 2U
Přepínatelné
sekundární vinutí

Primární jmenovitý proud A	Jmenovitý výkon VA	Třída 1	
		Sekundár 5A	Sekundár 1A
		Kč	Kč
200-100	5-2,5	520,-	590,-
300-150	5-2,5	520,-	590,-
	10-5	520,-	590,-
400-200	5-2,5	520,-	590,-
	10-5	520,-	590,-
500-250	5-2,5	520,-	590,-
	10-5	520,-	590,-
600-300	5-2,5	520,-	590,-
	10-5	520,-	590,-
800-400	5	520,-	
	5-2,5	520,-	590,-
	10-5	520,-	590,-
	15-7,5	520,-	590,-
1000-500	5-2,5	520,-	590,-
	10-5	520,-	590,-
	15-7,5	520,-	590,-

ASK 41.4 3U
Přepínatelné
sekundární vinutí

Primární jmenovitý proud A	Jmenovitý výkon VA	Třída 1	
		Sekundár 5A	Sekundár 1A
		Kč	Kč
400-200-100	10-5-2,5	560,-	630,-
600-300-150	10-5-2,5	560,-	630,-
800-400-200	10-5-2,5	560,-	630,-
1000-500-250	10-5-2,5	560,-	630,-
	15-7,5-2,5	560,-	630,-

Novinka**Násuvné transformátory proudu****ASK 412.4**

Primární lišta

40x12 mm

ASK 412.4 2U

30x15 mm

ASK 412.4 3U

Kulatý vodič

30,5 mm ϕ

Šířka transformátoru

70 mm

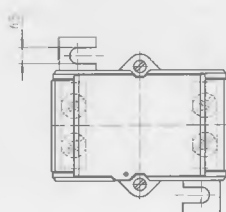
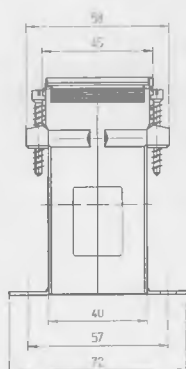
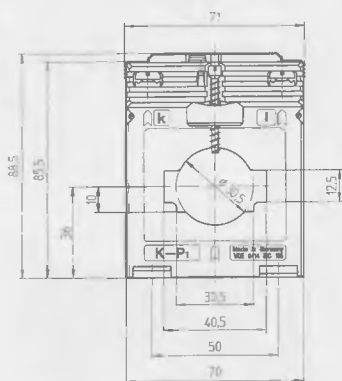
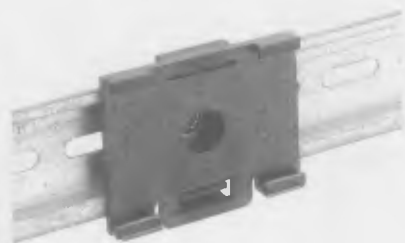

Primární jmenovitý proud A	Jmenovitý výkon VA	Třída 0,5	Třída 1
		Sekundár 5A Kč	Sekundár 5A Kč
50	1,25		420,-
	1,5		420,-
60	1,25		420,-
	1,5		420,-
75	1,5		420,-
	2,5		420,-
80	1,5		420,-
	2,5		420,-
100	1,5	715,-	420,-
	2,5		420,-
	3,75		420,-
150	1,5	600,-	420,-
	2,5	660,-	420,-
	5		420,-
200	2,5	615,-	420,-
	5		420,-
	10		420,-
250	1,5	600,-	420,-
	2,5	615,-	420,-
	5	765,-	420,-
	10		420,-
300	2,5	600,-	420,-
	5	615,-	420,-
	10		420,-
	15		420,-
400	2,5	570,-	420,-
	5	585,-	420,-
	10	785,-	420,-
	15		420,-
500	2,5	565,-	420,-
	5	585,-	420,-
	10	615,-	420,-
	15		420,-
600	2,5	535,-	420,-
	5	565,-	420,-
	10	595,-	420,-
	15		420,-
750	5	565,-	420,-
	10	595,-	420,-
	15	610,-	420,-
	30		420,-
800	5	565,-	420,-
	10	595,-	420,-
	15	610,-	420,-
	30		420,-

Příplatek: sekundár 1 A – 90

ASK 412.4 2U
Přepínatelné
sekundární vinutí

Primární jmenovitý proud A	Jmenovitý výkon VA	Třída 1	
		Sekundár 5A	Sekundár 1A
		Kč	Kč
200-100	5-2,5	645,-	920,-
300-150	5-2,5	645,-	920,-
	10-5	645,-	920,-
400-200	5-2,5	645,-	920,-
	10-5	645,-	920,-
500-250	5-2,5	645,-	920,-
	10-5	645,-	920,-
600-300	5-2,5	645,-	920,-
	10-5	645,-	920,-
800-400	5-2,5	645,-	920,-
	10-5	645,-	920,-
	15-7,5	645,-	920,-

ASK 412.4 3U
Přepínatelné
sekundární vinutí

Primární jmenovitý proud A	Jmenovitý výkon VA	Třída 1	
		Sekundár 5A	Sekundár 1A
		Kč	Kč
400-200-100	10-5-2,5	560,-	630,-
600-300-150	10-5-2,5	560,-	630,-
800-400-200	10-5-2,5	560,-	630,-
1000-500-250	10-5-2,5	560,-	630,-
	15-7,5-2,5	560,-	630,-



Násuvné transformátory proudu

ASK 41.6

Primární lišta

40x12 mm

30x15 mm

Kulatý vodič

32,0 mm ϕ

Šířka transformátoru

95 mm

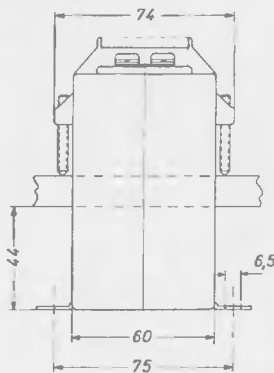
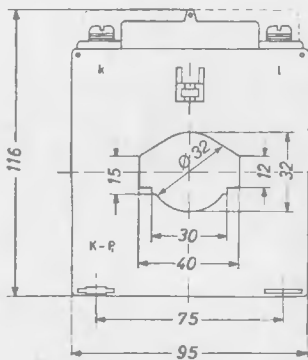
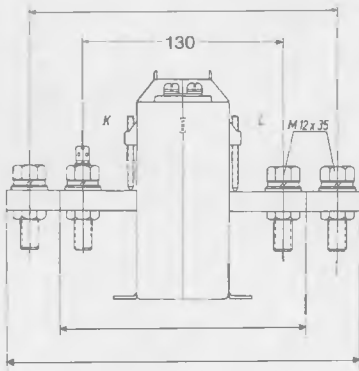

Primární jmenovitý proud A	Jmenovitý výkon VA	Třída 0,5	Třída 1
		Sekundár 5A Kč	Sekundár 5A Kč
50	1,5		790,-
	2,5		790,-
60	1,5		790,-
	2,5		790,-
75	1,5		790,-
	2,5		790,-
	5		790,-
80	2,5		790,-
	5		790,-
100	2,5		790,-
	5	790,-	790,-
	10		790,-
150	5		790,-
	10	890,-	790,-
	15		790,-
200	5		790,-
	10	790,-	790,-
	15		790,-
250	5		790,-
	10	790,-	790,-
	15		790,-
300	5		790,-
	10		790,-
	15		790,-
400	5		790,-
	10		790,-
	15		790,-
500	5		790,-
	10		790,-
	15		790,-
600	10		790,-
	15		790,-
	30		790,-
750	10		790,-
	15		790,-
	30		790,-
800	10		790,-
	15		790,-
	30		790,-
1000	15		790,-
	30		790,-
	45		790,-

Příplatek: sekundár 1 A – 90



Násuvné transformátory proudu

ASK 541.4

Primární lišta

40x10 mm

2x30x5 mm

Kulatý vodič

32,0 mm ϕ

Šířka transformátoru

85 mm

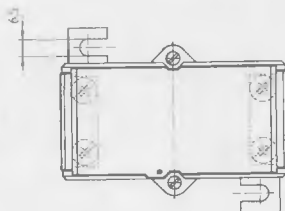
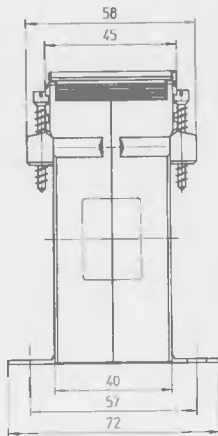
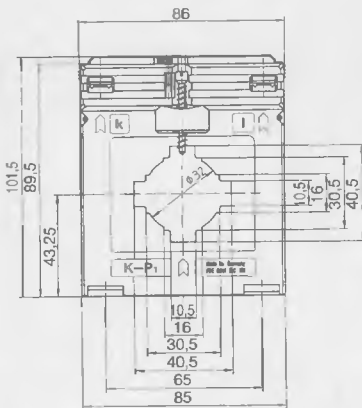

Primární jmenovitý proud A	Jmenovitý výkon VA	Třída 0,5	Třída I
		Sekundár 5A Kč	Sekundár 5A Kč
30	1,5		520,-
40	1,5		520,-
	2,5		520,-
50	1,5		520,-
	2,5		520,-
60	1,5	940,-	520,-
	2,5		520,-
75	1,5	940,-	520,-
	2,5	975,-	520,-
80	1,5	825,-	
	2,5	925,-	520,-
	5		520,-
100	2,5	925,-	
	5	940,-	520,-
	10		520,-
125	2,5	825,-	
	5	940,-	520,-
	10		520,-
150	2,5	825,-	520,-
	5	940,-	520,-
	10		520,-
200	2,5	750,-	
	5	825,-	520,-
	10	900,-	520,-
250	15	975,-	520,-
	2,5	675,-	
	5	750,-	520,-
300	10	900,-	520,-
	15	940,-	520,-
	2,5	525,-	
400	5	565,-	520,-
	10	790,-	520,-
	15	825,-	520,-
500	5	565,-	520,-
	10	585,-	520,-
	15	790,-	520,-
600	5	565,-	520,-
	10	595,-	520,-
	15	695,-	520,-
750	30		520,-
	10	585,-	520,-
	15	695,-	520,-
800	30	715,-	520,-
	10	600,-	520,-
	15	695,-	520,-
1000	30	730,-	520,-
	10	600,-	520,-
	15	695,-	520,-

Příplatek: sekundár 1 A – 120 Kč



Násuvné transformátory proudu

ASK 51.4

Primární lišta

50x12 mm

ASK 51.4 2U

2x40x10 mm

ASK 51.4 3U

Kulatý vodič

44,0 mm ϕ

Šířka transformátoru

85 mm

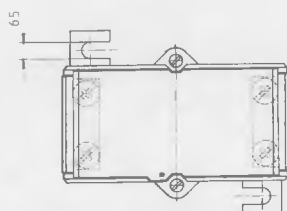
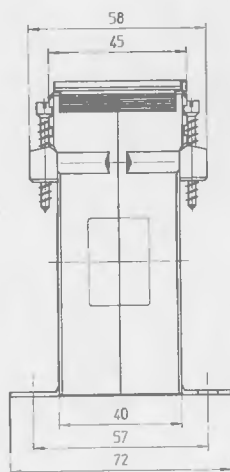
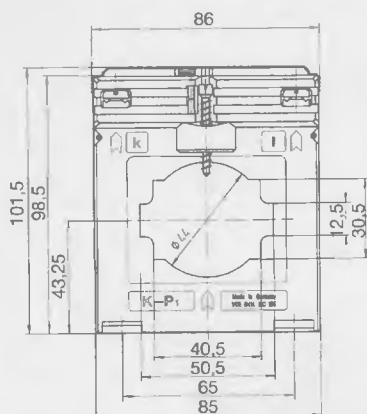

Primární jmenovitý proud A	Jmenovitý výkon VA	Třída 0,5	Třída 1
		Sekundár 5A Kč	Sekundár 5A Kč
100	1,5		520,-
150	1,5	790,-	520,-
	2,5	840,-	520,-
200	1,5	640,-	
	2,5	700,-	520,-
	5	730,-	520,-
250	1,5	600,-	
	2,5	640,-	520,-
	5	750,-	520,-
	10		520,-
300	2,5	545,-	520,-
	5	600,-	520,-
	10		520,-
400	2,5	560,-	520,-
	5	600,-	520,-
	10	675,-	520,-
	15		520,-
500	2,5	560,-	520,-
	5	610,-	520,-
	10	650,-	520,-
600	15		520,-
	2,5	560,-	520,-
	5	610,-	520,-
	10	650,-	520,-
750	15	695,-	520,-
	2,5	560,-	520,-
	5	620,-	520,-
	10	670,-	520,-
800	15		520,-
	5	560,-	520,-
	10	620,-	520,-
	15	670,-	520,-
1000	30		520,-
	5	590,-	520,-
	10	650,-	520,-
	15	690,-	520,-
1200	30		520,-
	5	630,-	520,-
	10	680,-	520,-
	15	720,-	520,-
1250	30		520,-
	5	630,-	520,-
	10	680,-	520,-
	15	720,-	520,-

Příplatek: sekundár 1 A – 120

ASK 51.4 2U
Přepínatelné
sekundární vinutí

Primární jmenovitý proud A	Jmenovitý výkon VA	Třída 1	
		Sekundár 5A	Sekundár 1A
		Kč	Kč
400-200	5-2,5	655,-	795,-
	10-5	655,-	795,-
500-250	5-2,5	655,-	795,-
	10-5	655,-	795,-
600-300	5-2,5	655,-	795,-
	10-5	655,-	795,-
800-400	5-2,5	655,-	795,-
	10-5	655,-	795,-
	15-7,5	655,-	795,-
1000-500	5-2,5	655,-	795,-
	10-5	655,-	795,-
	15-7,5	655,-	795,-
1200-600	5-2,5	655,-	795,-
	10-5	655,-	795,-
	15-7,5	655,-	795,-
	30-15	655,-	795,-

ASK 51.4 3U
Přepínatelné
sekundární vinutí

Primární jmenovitý proud A	Jmenovitý výkon VA	Třída 1	
		Sekundár 5A	Sekundár 1A
		Kč	Kč
800-400-200	10-5-2,5	710,-	850,-
1000-500-250	10-5-2,5	710,-	850,-
	15-7,5-2,5	710,-	850,-
1200-600-300	10-5-2,5	710,-	850,-
	15-7,5-2,5	710,-	850,-
1200-1000-300	7,5-5-2,5	710,-	850,-
1000-600-400	10-5-2,5	710,-	850,-
1000-600-300	15-10-5	710,-	850,-
600-400-200	15-7,5-5	710,-	850,-
1000-800-600	15-10-5	710,-	850,-
1000-600-300	10-5-2,5	710,-	850,-



Násuvné transformátory proudu

ASK 561.4

Primární lišta

60x10 mm

2x50x10 mm

Kulatý vodič

44,0 mm ϕ

Šířka transformátoru

85 mm

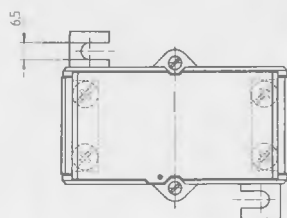
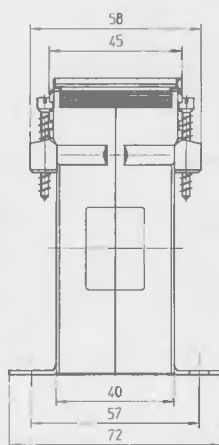
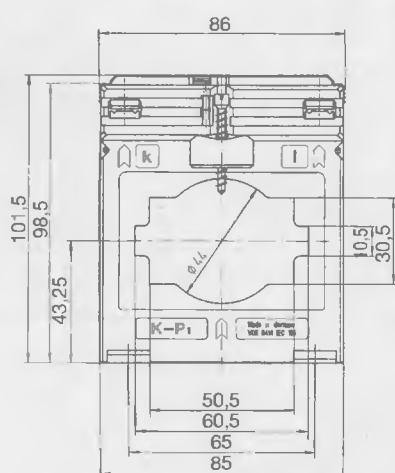

Primární jmenovitý proud A	Jmenovitý výkon VA	Třída 0,5	Třída I
		Sekundár 5A Kč	Sekundár 5A Kč
200	2,5		520,-
250	2,5		520,-
	5		520,-
300	2,5	640,-	520,-
	5	685,-	520,-
400	2,5	640,-	520,-
	5	685,-	520,-
	10		520,-
500	2,5	590,-	
	5	640,-	520,-
	10		520,-
600	15		520,-
	2,5	590,-	
	5	610,-	520,-
750	10	720,-	520,-
	15		520,-
	2,5	560,-	
800	5	630,-	520,-
	10	675,-	520,-
	15		520,-
1000	5	590,-	520,-
	10	660,-	520,-
	15	695,-	520,-
	30		520,-
1200	5	630,-	
	10	690,-	520,-
	15	730,-	520,-
	30		520,-
1250	5	650,-	
	10	710,-	520,-
	15	750,-	520,-
	30		520,-

Příplatek: sekundár 1 A – 120 Kč





Násuvné transformátory proudu

ASK 61.4

Primární lišta

60x10 mm

ASK 61.4 2U

2x50x10 mm

ASK 61.4 3U

Kulatý vodič

44,0 mm ϕ

Šířka transformátoru

95 mm

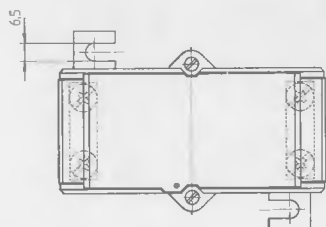
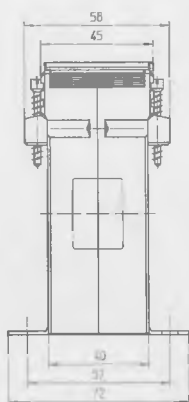
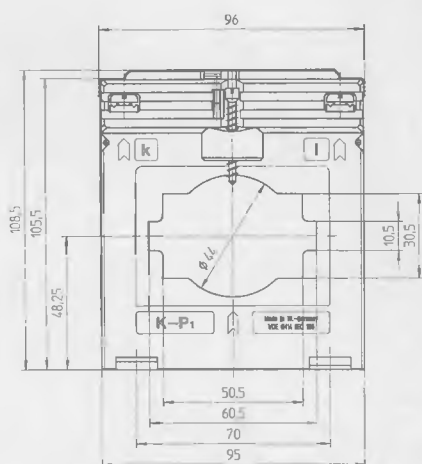

Primární jmenovitý proud A	Jmenovitý výkon VA	Třída 0,5		Třída 1	
		Sekundár 5A		Sekundár 5A	
		Kč		Kč	
200	1,5	640,-	520,-		
	2,5	750,-	520,-		
250	1,5	625,-	520,-		
	2,5	640,-	520,-		
300	1,5	625,-	520,-		
	2,5	640,-	520,-		
	5	750,-	520,-		
400	1,5	565,-	520,-		
	2,5	610,-	520,-		
	5	640,-	520,-		
	10	750,-	520,-		
500	1,5	530,-		520,-	
	2,5	565,-		520,-	
	5	625,-		520,-	
	10	720,-		520,-	
600	15	750,-		520,-	
	2,5	565,-		520,-	
	5	610,-		520,-	
750	10	720,-		520,-	
	15	810,-		520,-	
	2,5	540,-		520,-	
800	5	590,-		520,-	
	10	660,-		520,-	
	15	695,-		520,-	
1000	5	630,-		520,-	
	10	690,-		520,-	
	15	730,-		520,-	
	30	750,-		520,-	
1200	5	650,-		520,-	
	10	710,-		520,-	
	15	750,-		520,-	
1250	30	770,-		520,-	
	5	650,-		520,-	
	10	710,-		520,-	
1500	15	750,-		520,-	
	30	770,-		520,-	
	5	690,-		520,-	
	10	740,-		520,-	
1600	15	770,-		520,-	
	30	795,-		520,-	
	5	690,-		520,-	

Příplatek: sekundár 1 A – 120

ASK 61.4 2U
Přepínatelné
sekundární vinutí

Primární jmenovitý proud A	Jmenovitý výkon VA	Třída 1	
		Sekundár 5A	Sekundár 1A
		Kč	Kč
500-250	5-2,5	655,-	795,-
600-300	5-2,5	655,-	795,-
	10-5	655,-	795,-
800-400	5-2,5	655,-	795,-
	10-5	655,-	795,-
	15-7,5	655,-	795,-
1000-500	5-2,5	655,-	795,-
	10-5	655,-	795,-
	15-7,5	655,-	795,-
1200-600	5-2,5	655,-	795,-
	10-5	655,-	795,-
	15-7,5	655,-	795,-
1500-750	5-2,5	655,-	795,-
	10-5	655,-	795,-
	15-7,5	655,-	795,-
	30-15	655,-	795,-
1600-800	5-2,5	655,-	795,-
	10-5	655,-	795,-
	15-7,5	655,-	795,-
	30-15	655,-	795,-

ASK 61.4 3U
Přepínatelné
sekundární vinutí

Primární jmenovitý proud A	Jmenovitý výkon VA	Třída 1	
		Sekundár 5A	Sekundár 1A
		Kč	Kč
800-400-200	10-5-2,5	710,-	850,-
1000-500-250	10-5-2,5	710,-	850,-
	15-7,5-2,5	710,-	850,-
1000-600-300	10-5-2,5	710,-	850,-
	15-7,5-2,5	710,-	850,-
1200-600-300	10-5-2,5	710,-	850,-
	15-7,5-2,5	710,-	850,-
1500-750-400	10-5-2,5	710,-	850,-
	15-7,5-2,5	710,-	850,-
1600-800-400	10-5-2,5	710,-	850,-
	15-7,5-2,5	710,-	850,-
1000-600-400	10-5-2,5	710,-	850,-



Násuvné transformátory proudu

ASK 61.6

Primární lišta

60x10 mm

50x30 mm

Kulatý vodič

40,0 mm ϕ

Šířka transformátoru

95 mm

Primární jmenovitý proud A	Jmenovitý výkon VA	Třída 0,5	Třída 1
		Sekundár 5A Kč	Sekundár 5A Kč
100	1,5	1090,-	820,-
	2,5		820,-
150	1,5	1090,-	820,-
	2,5	1090,-	820,-
200	2,5	1090,-	820,-
	5	1090,-	820,-
	10		820,-
250	2,5	1090,-	
	5	1090,-	820,-
	10	1090,-	820,-
	15		820,-
300	5	1090,-	820,-
	10	1090,-	820,-
	15	1090,-	820,-
400	5	1090,-	820,-
	10	1090,-	820,-
	15	1090,-	820,-
	30		820,-
500	5	1090,-	820,-
	10	1090,-	820,-
	15	1090,-	820,-
	30		820,-
600	5	1090,-	820,-
	10	1090,-	820,-
	15	1090,-	820,-
	30		820,-
750	5	1090,-	820,-
	10	1090,-	820,-
	15	1090,-	820,-
	30		820,-
800	5	1090,-	820,-
	10	1090,-	820,-
	15	1090,-	820,-
	30		820,-
1000	10	1090,-	820,-
	15	1090,-	820,-
	30	1090,-	820,-
	45		820,-
1200	10	1090,-	820,-
	15	1090,-	820,-
	30	1090,-	820,-
	45		820,-

Násuvné transformátory proudu

ASK 61.6

Primární lišta

60x10 mm

50x30 mm

Kulatý vodič

40,0 mm ϕ

Šířka transformátoru

95 mm

Primární jmenovitý proud A	Jmenovitý výkon VA	Třída 0,5	Třída 1
		Sekundár 5A Kč	Sekundár 5A Kč
1250	10	1090,-	820,-
	15	1090,-	820,-
	30	1090,-	820,-
	45		820,-
1500	10	1090,-	820,-
	15	1090,-	820,-
	30	1090,-	820,-
	45		820,-
1600	10	1090,-	820,-
	15	1090,-	820,-
	30	1090,-	820,-
	45		820,-

Příplatek: sekundár 1 A – 120 Kč

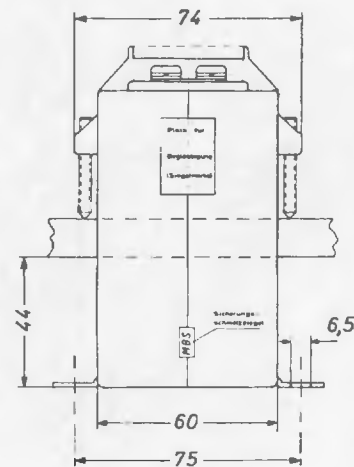
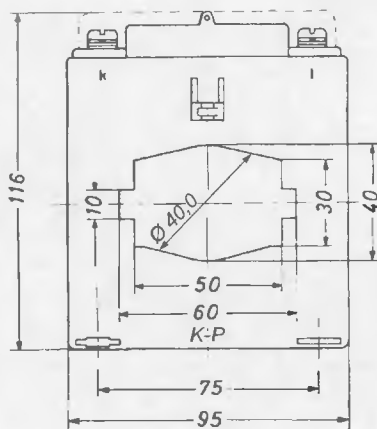



Násuvné transformátory proudu

ASK 63.4

Primární lišta

50x40 mm
60x30 mm

Kulatý vodič

44,0 mm ϕ

Šířka transformátoru

95 mm

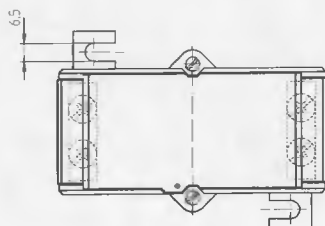
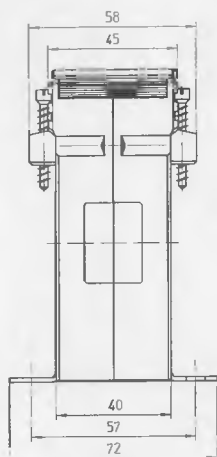
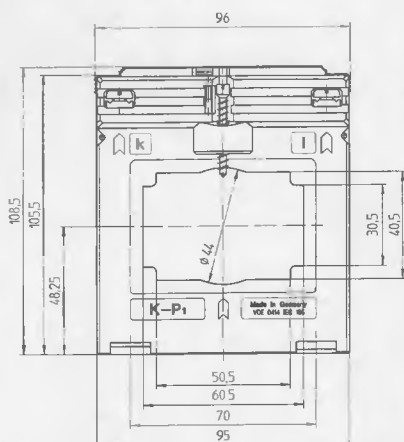

Primární jmenovitý proud A	Jmenovitý výkon VA	Třída 0,5	Třída 1
		Sekundár 5A Kč	Sekundár 5A Kč
300	1,5	660,-	620,-
	2,5	735,-	620,-
400	2,5	675,-	620,-
	5	790,-	620,-
500	5	750,-	620,-
	10		620,-
600	5	715,-	620,-
	10	765,-	620,-
	15		620,-
750	5	615,-	620,-
	10	675,-	620,-
	15	735,-	620,-
800	5	615,-	620,-
	10	675,-	620,-
	15	735,-	620,-
1000	5	640,-	620,-
	10	690,-	620,-
	15	735,-	620,-
1200	5	655,-	620,-
	10	705,-	620,-
	15	750,-	620,-
1250	5	655,-	620,-
	10	705,-	620,-
	15	750,-	620,-
1500	5	715,-	620,-
	10	735,-	620,-
	15	790,-	620,-
1600	5	715,-	620,-
	10	735,-	620,-
	15	790,-	620,-
1800	5	735,-	620,-
	10	760,-	620,-
	15	810,-	620,-
2000	5	735,-	620,-
	10	760,-	620,-
	15	810,-	620,-

Příplatek: sekundár 1 A – 120 Kč

Násuvné transformátory proudu ASK 63.6



Novinka

Primární lišta 60x30 mm
Kulatý vodič 30,0 mm ϕ
Šířka transformátoru 88 mm

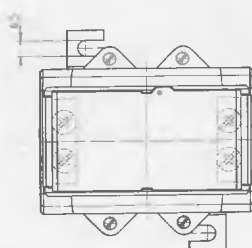
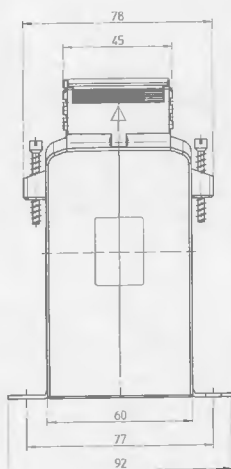
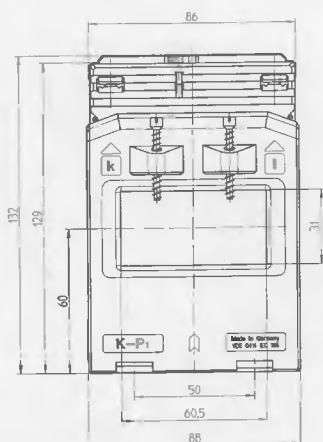

Primární jmenovitý proud A	Jmenovitý výkon VA	Třída 1	
		Sekundár 5A Kč	Sekundár 1A Kč
200	1,5	895,-	985,-
	2,5	895,-	985,-
250	1,5	895,-	985,-
	2,5	895,-	985,-
300	1,5	895,-	985,-
	2,5	895,-	985,-
	5	895,-	985,-
	10	895,-	985,-
400	2,5	895,-	985,-
	5	895,-	985,-
	10	895,-	985,-
500	2,5	895,-	985,-
	5	895,-	985,-
	10	895,-	985,-
	15	895,-	985,-
600	2,5	895,-	985,-
	5	895,-	985,-
	10	895,-	985,-
	15	895,-	985,-
750	2,5	895,-	985,-
	5	895,-	985,-
	10	895,-	985,-
	15	895,-	985,-
800	2,5	895,-	985,-
	5	895,-	985,-
	10	895,-	985,-
	15	895,-	985,-
1000	5	895,-	985,-
	10	895,-	985,-
	15	895,-	985,-
	30	895,-	985,-
1200	5	895,-	985,-
	10	895,-	985,-
	15	895,-	985,-
	30	895,-	985,-
1250	5	895,-	985,-
	10	895,-	985,-
	15	895,-	985,-
	30	895,-	985,-
1500 1600	5	895,-	985,-
	10	895,-	985,-
	15	895,-	985,-
2000	30	895,-	985,-
	5	895,-	985,-
	10	895,-	985,-
2000	15	895,-	985,-
	30	895,-	985,-
	5	895,-	985,-

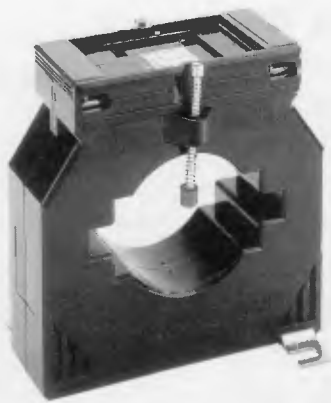

Násuvné transformátory proudu

ASK 81.4

Primární lišta

80x10 mm

ASK 81.4 2U

60x30 mm

ASK 81.4 3U

2x60x10 mm

Kulatý vodič

55,0 mm ϕ

Šířka transformátoru

120 mm

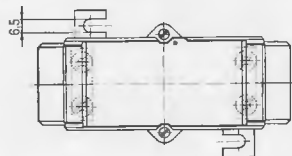
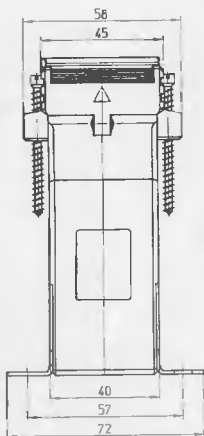
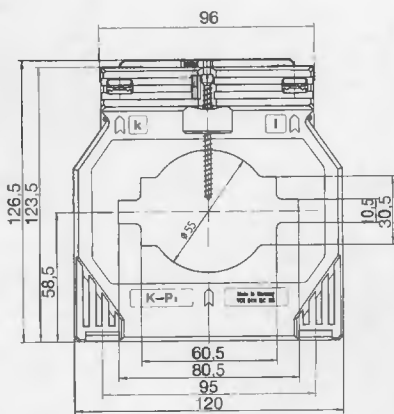

Primární jmenovitý proud A	Jmenovitý výkon VA	Třída 0,5	Třída 1
		Sekundár 5A	Sekundár 5A
		Kč	Kč
400	2,5	860,-	820,-
	5	875,-	820,-
500	2,5	860,-	820,-
	5	875,-	820,-
	10	910,-	820,-
600	2,5	860,-	820,-
	5	875,-	820,-
	10	910,-	820,-
750	2,5	840,-	820,-
	5	860,-	820,-
	10	890,-	820,-
	15	920,-	820,-
800	2,5	840,-	820,-
	5	860,-	820,-
	10	890,-	820,-
	15	920,-	820,-
1000	5	860,-	820,-
	10	890,-	820,-
	15	920,-	820,-
	30		820,-
1200	5	870,-	820,-
	10	910,-	820,-
	15	960,-	820,-
	30		820,-
1250	5	870,-	820,-
	10	910,-	820,-
	15	960,-	820,-
	30		820,-
1500	5	900,-	
	10	940,-	820,-
	15	975,-	820,-
	30		820,-
	45		820,-
1600	5	900,-	
	10	940,-	820,-
	15	975,-	820,-
	30		820,-
	45		820,-
2000	10	1050,-	820,-
	15	1110,-	820,-
	30		820,-
	45		820,-

Příplatek: sekundár 1 A – 220 Kč

ASK 81.4 2U
Přepínatelné
sekundární vinutí

Primární jmenovitý proud A	Jmenovitý výkon VA	Třída 1	
		Sekundár 5A	Sekundár 1A
		Kč	Kč
1000-500	10-5	1090,-	1310,-
	15-7,5	1090,-	1310,-
1200-600	10-5	1090,-	1310,-
	15-7,5	1090,-	1310,-
1500-750	10-5	1090,-	1310,-
	15-7,5	1090,-	1310,-
	30-15	1090,-	1310,-
1600-800	10-5	1090,-	1310,-
	15-7,5	1090,-	1310,-
	30-15	1090,-	1310,-
2000-1000	10-5	1090,-	1310,-
	15-7,5	1090,-	1310,-
	30-15	1090,-	1310,-

ASK 81.4 3U
Přepínatelné
sekundární vinutí

Primární jmenovitý proud A	Jmenovitý výkon VA	Třída 1	
		Sekundár 5A	Sekundár 1A
		Kč	Kč
2000-1500-1000	30-15-10	1260,-	1320,-
2000-1000-500	30-10-5	1260,-	1320,-
1600-800-400	15-10-5	1260,-	1320,-
1500-1000-500	15-10-5	1260,-	1320,-
1200-800-600	15-10-5	1260,-	1320,-
1500-1000-750	15-10-5	1260,-	1320,-
1000-750-500	10-5-2,5	1260,-	1320,-



Násuvné transformátory proudu

ASK 101.4

Primární lišta

100x10 mm

ASK 101.4 2U

2x80x10 mm

Kulatý vodič

70,0 mm ϕ

Šířka transformátoru

130 mm

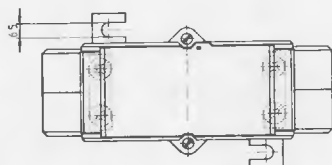
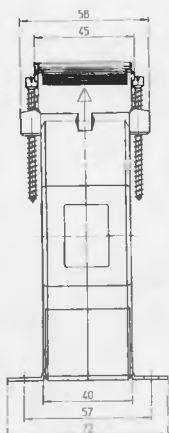
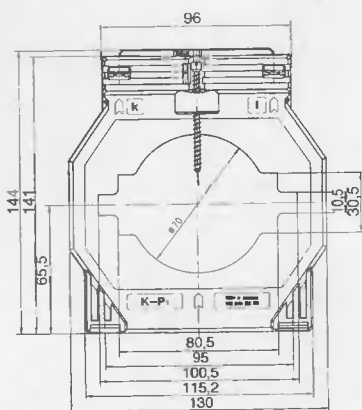

Primární jmenovitý proud A	Jmenovitý výkon VA	Třída 0,5		Třída 1	
		Sekundár 5A		Sekundár 5A	
		Kč		Kč	
500	2,5	950,-			
	5	970,-		940,-	
	10			940,-	
600	2,5	950,-			
	5	970,-		940,-	
	10			940,-	
750	2,5	940,-			
	5	960,-		940,-	
	10			940,-	
800	5	940,-		940,-	
	10	960,-		940,-	
	15			940,-	
1000	5	950,-		940,-	
	10	970,-		940,-	
	15			940,-	
	30			940,-	
1200	5	950,-		940,-	
	10	970,-		940,-	
	15			940,-	
	30			940,-	
1250	5	950,-		940,-	
	10	970,-		940,-	
	15			940,-	
	30			940,-	
1500	5	950,-		940,-	
	10	970,-		940,-	
	15	990,-		940,-	
	30			940,-	
1600	5	950,-			
	10	970,-		940,-	
	15	990,-		940,-	
	30			940,-	
	45			940,-	
1800	5	950,-			
	10	970,-		940,-	
	15	990,-		940,-	
	30			940,-	
	45			940,-	

Násuvné transformátory proudu

ASK 101.4

Primární lišta

100x10 mm

ASK 101.4 2U

2x80x10 mm

Kulatý vodič

70,0 mm ϕ

Šířka transformátoru

130 mm

Primární jmenovitý proud A	Jmenovitý výkon VA	Třída 0,5	Třída 1
		Sekundár 5A Kč	Sekundár 5A Kč
2000	5	980,-	
	10	1060,-	940,-
	15	1120,-	940,-
	30		940,-
	45		940,-
2500	5	990,-	
	10	1070,-	940,-
	15	1140,-	940,-
	30		940,-
	45		940,-

Příplatek: sekundár 1 A – 270 Kč

ASK 101.4 2U Přepínatelné sekundární vinutí

Primární jmenovitý proud A	Jmenovitý výkon VA	Třída 1	
		Sekundár 5A Kč	Sekundár 1A Kč
1200-600	10-5	1090,-	1360,-
	15-7,5	1090,-	1360,-
1500-750	10-5	1090,-	1360,-
	15-7,5	1090,-	1360,-
1600-800	10-5	1090,-	1360,-
	15-7,5	1090,-	1360,-
	30-15	1090,-	1360,-
2000-1000	10-5	1090,-	1360,-
	15-7,5	1090,-	1360,-
	30-15	1090,-	1360,-
2500-1250	10-5	1090,-	1360,-
	15-7,5	1090,-	1360,-
	30-15	1090,-	1360,-



Násuvné transformátory proudu

ASK 103.3

Primární lišta 2x100x10 mm
3x80x10 mm

Kulatý vodič 85,0 mm ϕ
Šířka transformátoru 172 mm

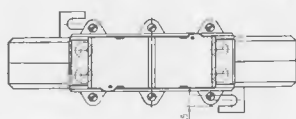
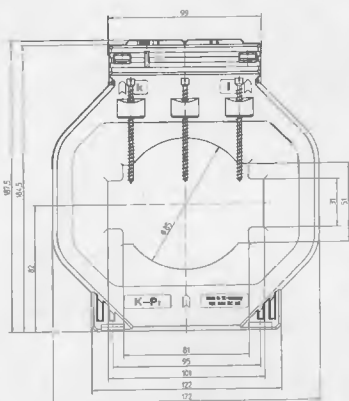

Primární jmenovitý proud A	Jmenovitý výkon VA	Třída 0,5	Třída 1
		Sekundár 5A	Sekundár 5A
		Kč	Kč
750	2,5	1120,-	
	5		1090,-
	10		1090,-
800	2,5	1120,-	
	5	1140,-	1090,-
	10		1090,-
	15		1090,-
1000	5	1100,-	1090,-
	10	1140,-	1090,-
	15		1090,-
1200	5	1180,-	1090,-
	10	1210,-	1090,-
	15		1090,-
	30		1090,-
1250	5	1180,-	1090,-
	10	1210,-	1090,-
	15	1240,-	1090,-
	30		1090,-
1500	10	1210,-	1090,-
	15	1240,-	1090,-
	30		1090,-
	45		1090,-
1600	10	1210,-	1090,-
	15	1240,-	1090,-
	30		1090,-
2000	10	1280,-	1090,-
	15	1320,-	1090,-
	30	1390,-	1090,-
	45		1090,-
2500	10	1280,-	1090,-
	15	1360,-	1090,-
	30	1510,-	1090,-
	45		1090,-
3000	10	1390,-	1090,-
	15	1430,-	1090,-
	30	1510,-	1090,-
	45		1090,-

Příplatek: sekundár 1 A – 270 Kč



Násuvné transformátory proudu ASK 105.6

Novinka

Primární lišta 100x55 mm
Kulatý vodič 55,0 mm ϕ
Šířka transformátoru 129 mm

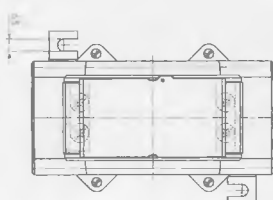
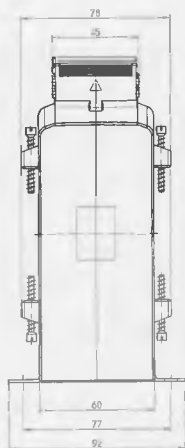
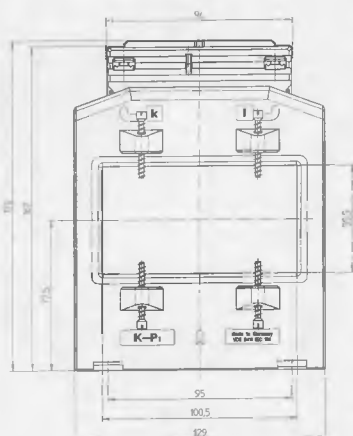

Primární jmenovitý proud A	Jmenovitý výkon VA	Třída 0,5	Třída 1
		Sekundár 5A Kč	Sekundár 5A Kč
600	2,5	1280,-	
	5	1395,-	1140,-
	10		1140,-
750	2,5	1280,-	
	5	1395,-	1140,-
	10		1140,-
800	5	1280,-	1140,-
	10	1395,-	1140,-
1000	5	1280,-	1140,-
	10		1140,-
1200	5	1280,-	1140,-
	10	1395,-	1140,-
	15		1140,-
1250	5	1290,-	1140,-
	10	1395,-	1140,-
	15	1470,-	1140,-
1500	5	1320,-	1140,-
	10	1450,-	1140,-
	15	1530,-	1140,-
	30		1140,-
1800	5	1340,-	1140,-
	10	1460,-	1140,-
	15	1550,-	1140,-
	30		1140,-
2000	10	1490,-	1140,-
	15	1580,-	1140,-
	30	1640,-	1140,-
	45		1140,-
2500	10	1510,-	1140,-
	15	1560,-	1140,-
	30	1660,-	1140,-
	45		1140,-
3000	10	1540,-	1140,-
	15	1600,-	1140,-
	30	1690,-	1140,-
	45		1140,-
4000	10	1580,-	1140,-
	15	1640,-	1140,-
	30	1730,-	1140,-
	45		1140,-

Příplatek: sekundár 1 A – 270 Kč



Násuvné transformátory proudu

ASK 123.3

Primární lišta

2x120x10 mm

3x100x10 mm

Kulatý vodič

100,0 mm ϕ

Šířka transformátoru

172 mm

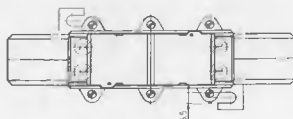
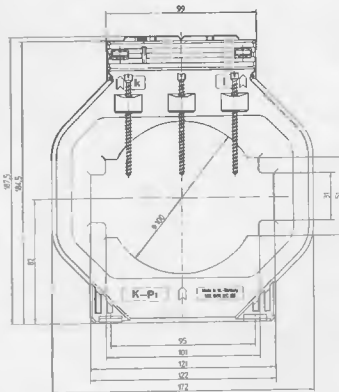

Primární jmenovitý proud A	Jmenovitý výkon VA	Třída 0,5		Třída 1	
		Sekundár 5A		Sekundár 5A	
		Kč		Kč	
1000	5	1210,-	1090,-		
	10		1090,-		
1200	5	1210,-	1090,-		
	10	1240,-	1090,-		
	15		1090,-		
1250	5	1210,-	1090,-		
	10	1250,-	1090,-		
	15	1290,-	1090,-		
1500	5	1240,-	1090,-		
	10	1280,-	1090,-		
	15	1320,-	1090,-		
	30		1090,-		
1800	5	1240,-	1090,-		
	10	1280,-	1090,-		
	15	1330,-	1090,-		
	30		1090,-		
2000	5	1320,-			
	10	1350,-	1090,-		
	15	1390,-	1090,-		
	30	1470,-	1090,-		
	45		1090,-		
2500	10	1390,-	1090,-		
	15	1490,-	1090,-		
	30	1580,-	1090,-		
	45		1090,-		
3000	10	1490,-	1090,-		
	15	1510,-	1090,-		
	30	1620,-	1090,-		
	45		1090,-		
4000	10	1680,-	1090,-		
	15	1760,-	1090,-		
	30	1880,-	1090,-		
	45		1090,-		

Příplatek: sekundár 1 A – 270 Kč

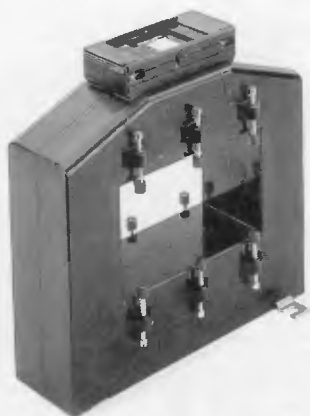

Násuvné transformátory proudu ASK 127.6

Novinka

Primární lišta 120x72 mm
Šířka transformátoru 205 mm

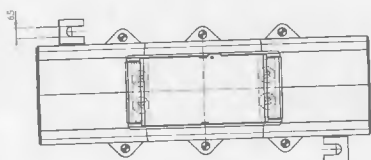
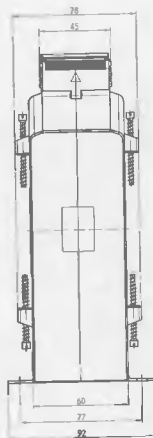
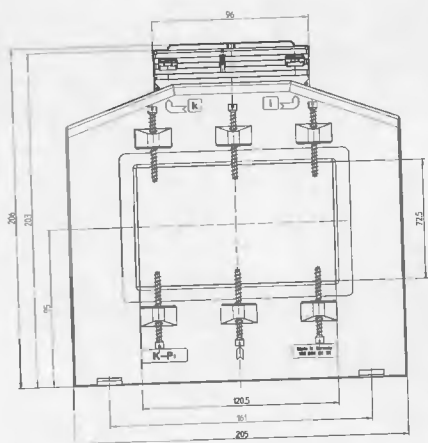

Primární jmenovitý proud A	Jmenovitý výkon VA	Třída 0,5	Třída 1
		Sekundár 5A Kč	Sekundár 5A Kč
1000	5	2450,-	1610,-
	10		1610,-
1200	5	2450,-	1610,-
	10	2520,-	1610,-
	15		1610,-
1250	5	2480,-	1610,-
	10	2550,-	1610,-
	15	2680,-	1610,-
	30	2860,-	1610,-
1500	5	2520,-	1610,-
	10	2590,-	1610,-
	15	2730,-	1610,-
	30	2900,-	1610,-
1800	5	2550,-	1610,-
	10	2620,-	1610,-
	15	2750,-	1610,-
	30	2930,-	1610,-
2000	10	2730,-	1610,-
	15	2790,-	1610,-
	30	2930,-	1610,-
	45		1610,-
2500	10	2790,-	1610,-
	15	2860,-	1610,-
	30	3000,-	1610,-
	45		1610,-
3000	10	2890,-	1610,-
	15	3040,-	1610,-
	30	3180,-	1610,-
	45		1610,-
4000	10	3200,-	1610,-
	15	3270,-	1610,-
	30	3410,-	1610,-
	45		1610,-
5000	10	3540,-	1610,-
	15	3610,-	1610,-
	30	3820,-	1610,-
	45		1610,-
6000	10	3890,-	1610,-
	15	3950,-	1610,-
	30	4090,-	1610,-
	45		1610,-

Příplatek: sekundár 1 A
třída přesnosti 0,5 - 780 Kč
třída přesnosti 1 - 270 Kč



Násuvné transformátory proudu ASK 129.10

Novinka

Primární lišta 120x90 mm
Šířka transformátoru 250 mm

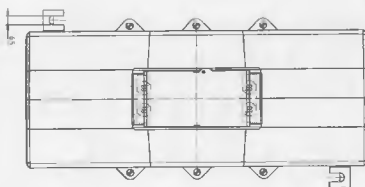
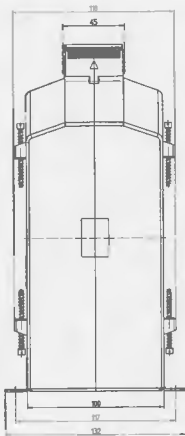
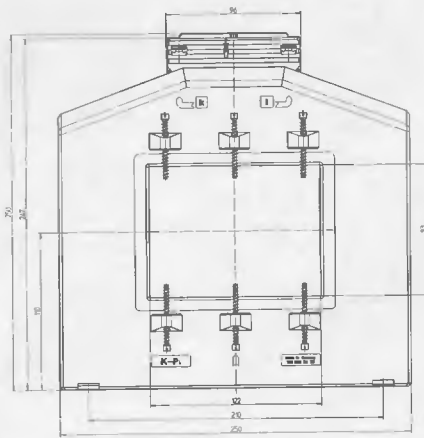

Primární jmenovitý proud A	Jmenovitý výkon VA	Třída 0,5	Třída 1
		Sekundár 5A Kč	Sekundár 5A Kč
1000	5	5330,-	4940,-
	10		4990,-
	15		5070,-
1200	5	5330,-	4940,-
	10	5460,-	5070,-
	15		5120,-
1250	5	5380,-	4990,-
	10	5510,-	5140,-
	15		5270,-
1500	10	5590,-	5200,-
	15	5850,-	5460,-
	30	6180,-	5790,-
1600	10	5610,-	5220,-
	15	5870,-	5480,-
	30	6210,-	5820,-
1800	10	5640,-	5250,-
	15	5900,-	5510,-
	30	6500,-	6110,-
2000	10	5850,-	5460,-
	15	5980,-	5590,-
	30	6240,-	5850,-
2500	15	6110,-	5720,-
	30	6370,-	5980,-
	45	6500,-	6110,-
3000	15	6440,-	6050,-
	30	6830,-	6440,-
	45	7040,-	6650,-
4000	15	6890,-	6500,-
	30	7150,-	6760,-
	45	7330,-	6940,-
5000	15	7280,-	6890,-
	30	7930,-	7540,-
	45	8030,-	7640,-
6000	15	8190,-	7800,-
	30	8450,-	8060,-
	45	8520,-	8130,-
7500	15	8260,-	7870,-
	30	8500,-	8110,-
	45	8710,-	8320,-
8000	15	8600,-	8210,-
	30	8810,-	8420,-
	45	8910,-	8520,-
10000	15	8710,-	8320,-
	30	8890,-	8560,-
	45	8990,-	8630,-

Příplatek: sekundár 1 A – 1560

Transformátory proudu závitového provedení WSK 30



Šířka transformátoru 60 mm

Primární jmenovitý proud A	Jmenovitý výkon VA	Třída 0,5	Třída 1
		Sekundár 5A Kč	Sekundár 5A Kč
1	2,5	790,-	765,-
	5		765,-
2,5	2,5	790,-	765,-
	5		765,-
5	2,5	790,-	765,-
	5		765,-
10	2,5	810,-	765,-
	5		765,-
15	2,5	810,-	765,-
	5		765,-
20	2,5	830,-	765,-
	5		765,-

Příplatek: sekundár 1 A – 120 Kč

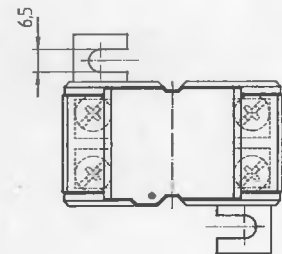
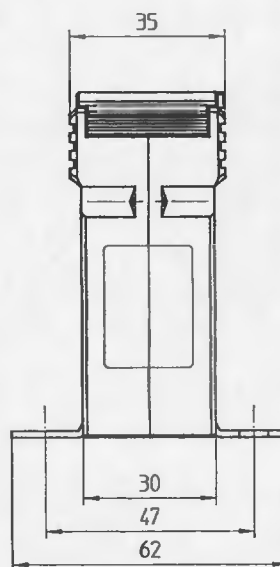
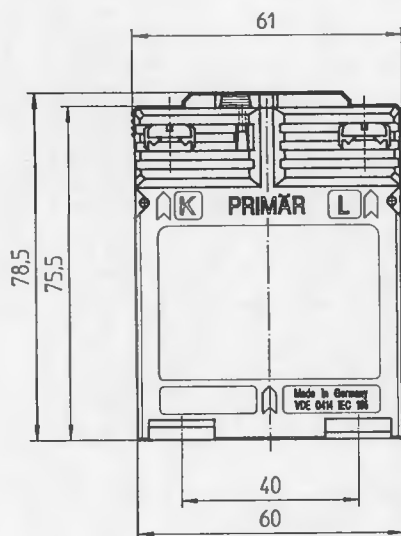

Transformátory proudu závitového provedení WSK 40

Šířka transformátoru 70 mm

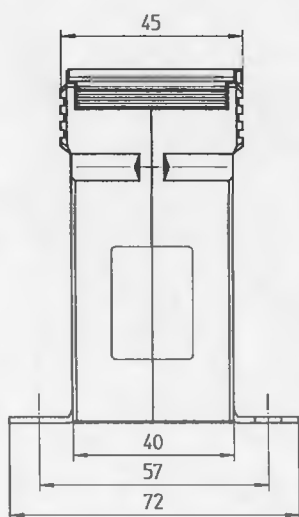
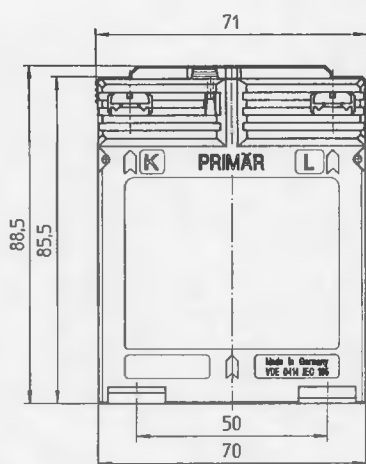

Primární jmenovitý proud A	Jmenovitý výkon VA	Třída 0,5	Třída 1
		Sekundár 5A Kč	Sekundár 5A Kč
1	2,5	830,-	765,-
	5	900,-	765,-
	10	970,-	765,-
	15		765,-
2,5	2,5	830,-	765,-
	5	900,-	765,-
	10	970,-	765,-
	15		765,-
5	2,5	750,-	765,-
	5	815,-	765,-
	10	860,-	765,-
	15		765,-
10	2,5	750,-	765,-
	5	815,-	765,-
	10	860,-	765,-
	15		765,-
15	2,5	750,-	765,-
	5	830,-	765,-
	10	890,-	765,-
	15		765,-
20	2,5	750,-	765,-
	5	860,-	765,-
	10	890,-	765,-
	15		765,-
25	2,5	750,-	765,-
	5	860,-	765,-
	10	930,-	765,-
	15		765,-
30	2,5	790,-	765,-
	5	860,-	765,-
	10		765,-
40	2,5	830,-	765,-
	5	900,-	765,-
	10		765,-

Příplatek: sekundár 1 A – 120 Kč

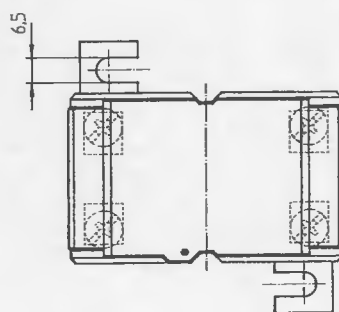



Transformátory proudu závitového provedení WSK 60

Šířka transformátoru 70 mm

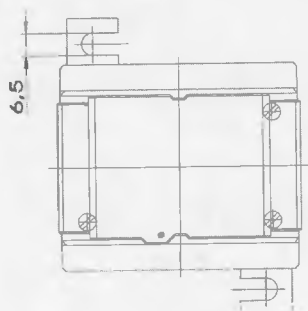
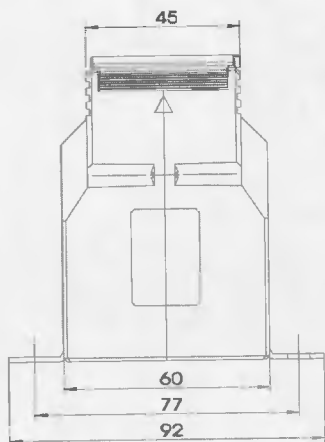
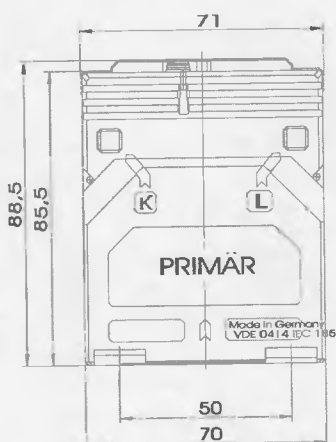

Primární jmenovitý proud A	Jmenovitý výkon VA	Třída 0,5	Třída 1
		Sekundár 5A Kč	Sekundár 5A Kč
5	2,5	790,-	890,-
	5	850,-	890,-
	10	900,-	890,-
	15		890,-
10	2,5	790,-	890,-
	5	850,-	890,-
	10	900,-	890,-
	15		890,-
15	2,5	790,-	890,-
	5	870,-	890,-
	10	930,-	890,-
	15		890,-
20	2,5	790,-	890,-
	5	900,-	890,-
	10	930,-	890,-
	15		890,-
25	2,5	790,-	890,-
	5	900,-	890,-
	10	970,-	890,-
	15		890,-
30	2,5	830,-	890,-
	5	900,-	890,-
	10	970,-	890,-
	15		890,-
40	2,5	845,-	890,-
	5	910,-	890,-
	10	980,-	890,-
	15		890,-
50	2,5	845,-	890,-
	5	910,-	890,-
	10	980,-	890,-
	15		890,-
60	2,5	860,-	890,-
	5	930,-	890,-
	10	995,-	890,-
	15		890,-
75	2,5	870,-	890,-
	5	940,-	890,-
	10	1020,-	890,-
	15		890,-

Příplatek: sekundár 1 A – 120 Kč



Transformátory proudu závitového provedení WSK 70.6 N

Novinka

Šířka transformátoru 70 mm

Primární jmenovitý proud A	Jmenovitý výkon VA	Třída 0,5	Třída 1
		Sekundár 5A Kč	Sekundár 5A Kč
25	2,5	960,-	960,-
	5	975,-	960,-
	10	990,-	960,-
	15		960,-
30	2,5	960,-	960,-
	5	975,-	960,-
	10	990,-	960,-
	15		960,-
40	2,5	960,-	960,-
	5	975,-	960,-
	10	990,-	960,-
	15		960,-
50	2,5	960,-	960,-
	5	975,-	960,-
	10	990,-	960,-
	15		960,-
60	2,5	960,-	960,-
	5	975,-	960,-
	10	990,-	960,-
	15		960,-
75	2,5	960,-	960,-
	5	975,-	960,-
	10	990,-	960,-
	15		960,-
80	2,5	960,-	960,-
	5	975,-	960,-
	10	990,-	960,-
	15		960,-
100	2,5	960,-	960,-
	5	975,-	960,-
	10	990,-	960,-
	15		960,-
150	2,5	960,-	960,-
	5	975,-	960,-
	10	990,-	960,-
	15		960,-

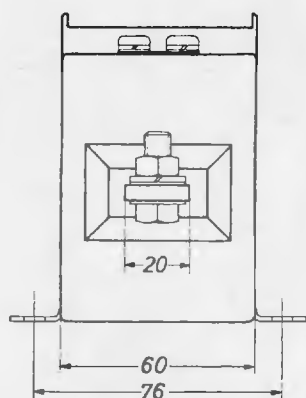
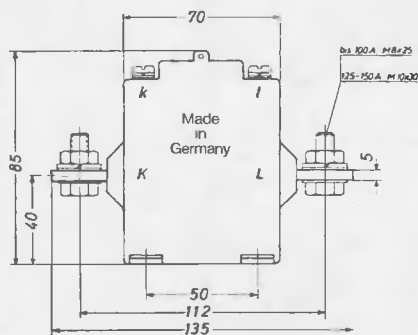

Příplatek: sekundár 1 A – 120 Kč

Transformátory proudu závitového provedení WSK 31.5

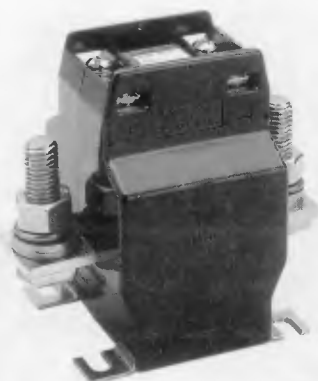

Šířka transformátoru 70 mm

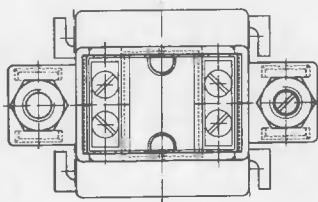
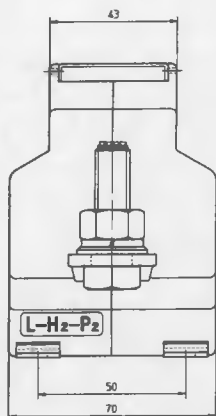
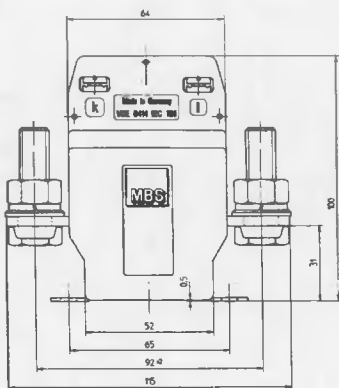

Primární jmenovitý proud A	Jmenovitý výkon VA	Třída 0,5	
		Sekundár 5A Kč	Sekundár 1A Kč
25	2,5	1190,-	1460,-
	5	1190,-	1460,-
	10	1190,-	1460,-
	15	1190,-	1460,-
30	2,5	1190,-	1460,-
	5	1190,-	1460,-
	10	1190,-	1460,-
	15	1190,-	1460,-
40	2,5	1190,-	1460,-
	5	1190,-	1460,-
	10	1190,-	1460,-
	15	1190,-	1460,-
50	2,5	1190,-	1460,-
	5	1190,-	1460,-
	10	1190,-	1460,-
	15	1190,-	1460,-
60	2,5	1190,-	1460,-
	5	1190,-	1460,-
	10	1190,-	1460,-
	15	1190,-	1460,-
75	2,5	1190,-	1460,-
	5	1190,-	1460,-
	10	1190,-	1460,-
	15	1190,-	1460,-
80	2,5	1190,-	1460,-
	5	1190,-	1460,-
	10	1190,-	1460,-
	15	1190,-	1460,-
100	2,5	1190,-	1460,-
	5	1190,-	1460,-
	10	1190,-	1460,-
	15	1190,-	1460,-
150	2,5	1190,-	1460,-
	5	1190,-	1460,-
	10	1190,-	1460,-
	15	1190,-	1460,-



Násuvné transformátory proudu ASG 41.5

Primární lišta 1x40x10 mm
2x30x10 mm
Šířka transformátoru 80 mm

Použití: zvýšená odolnost proti vlhkosti a mechanickému

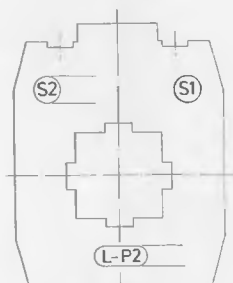
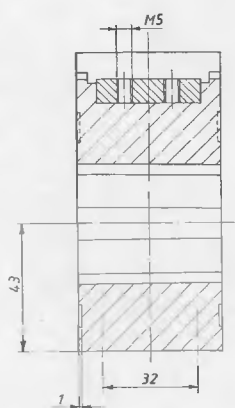
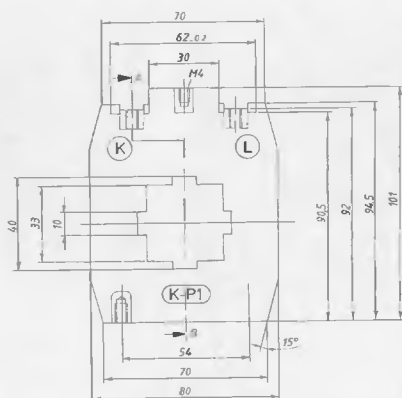

Primární jmenovitý proud A	Jmenovitý výkon VA	Třída 0,5	Třída 1
		Sekundár 5A Kč	Sekundár 5A Kč
100	1,5		1440,-
	2,5		1540,-
150	2,5	1880,-	1440,-
	5		1540,-
200	2,5	1800,-	1390,-
	5	1880,-	1390,-
	10		1540,-
250	2,5	1770,-	1360,-
	5	1830,-	1360,-
	10		1500,-
300	2,5	1770,-	1360,-
	5	1830,-	1360,-
	10		1500,-
400	2,5	1620,-	1230,-
	5	1680,-	1230,-
	10		1360,-
500	2,5	1590,-	
	5	1650,-	1210,-
	10	1710,-	1330,-
	15		1380,-
600	2,5	1560,-	
	5	1620,-	1150,-
	10	1680,-	1270,-
	15		1320,-
750	2,5	1575,-	
	5	1640,-	1160,-
	10	1700,-	1290,-
	15		1340,-
800	2,5	1580,-	
	5	1640,-	1160,-
	10	1700,-	1290,-
	15		1340,-
1000	5	1545,-	1160,-
	10	1640,-	1290,-
	15	1700,-	1340,-
1200	5	1620,-	1280,-
	10	1790,-	1420,-
	15	1860,-	1470,-
	30		1540,-
1250	5	1620,-	1280,-
	10	1790,-	1420,-
	15	1860,-	1470,-
	30		1540,-

Příplatek: sekundár 1 A – 180 Kč



Sčítací transformátory proudu KSU 2

Primární jmenovitý proud A	Jmenovitý výkon VA	Třída 0,5	Třída 1
		Sekundár 5A Kč	Sekundár 5A Kč
5 + 5	5	1720,-	1470,-
	10	1890,-	1700,-
	15	2100,-	1810,-
	20		1980,-
	25		2040,-
	30		2190,-

Provedení:

Transformátor závitového provedení až s 3 vzájemně nezávislými primárními vstupními obvody.

Primární jmenovitý proud 5A příp. 1A
Sekundární jmenovitý proud 5A příp. 1A

Příkon P_0

Sek. 5A $P_0 < 8 \text{ VA}$
Sek. 1A $P_0 < 5 \text{ VA}$

Poměr primárního jmenovitého proudu hlavního transformátoru s nejnižším převodem ku součtu primárních jmenovitých proudů všech hlavních transformátorů nesmí být větší než 1:8.

Příplatek: primár 1 A - 360 Kč
sekundár 1 A - 270 Kč

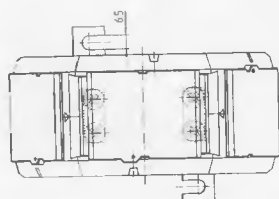
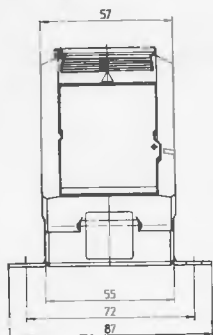
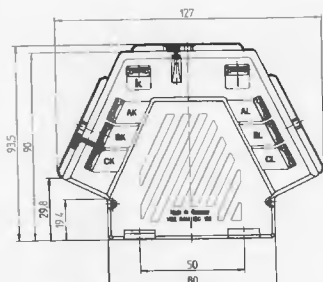

Sčítací transformátory proudu KSU 3

Primární jmenovitý proud A	Jmenovitý výkon VA	Třída 0,5	Třída 1
		Sekundár 5A Kč	Sekundár 5A Kč
5 + 5 + 5	5	1950,-	1670,-
	10	2110,-	1830,-
	15	2340,-	2050,-
	30		2520,-

Příplatek: primár 1 A - 360 Kč
sekundár 1 A - 270 Kč

Důležité:

Při objednávání je nutné vždy uvést převod, výkon (VA), třídu přesnosti připojených hlavních transformátorů.



Sčítací transformátory proudu SUSK 3

Primární jmenovitý proud A	Jmenovitý výkon VA	Třída 0,5	Třída 1
		Sekundár 5A Kč	Sekundár 5A Kč
5 + 5 + 5	5	2170,-	1890,-
	10	2330,-	2050,-
	15	2560,-	2210,-
	30		2730,-

Příplatek: primár 1 A - 270 Kč
sekundár 1 A - 270 Kč

Provedení:

Transformátor závitového provedení s 3 až 8 vzájemně nezávislými primárními vstupními obvody.

Primární jmenovitý proud 5A příp. 1A
Sekundární jmenovitý proud 5A příp. 1A

Příkon P_0

Sek. 5A $P_0 < 8$ VA
Sek. 1A $P_0 < 5$ VA

Poměr primárního jmenovitého proudu hlavního transformátoru s nejnižším převodem ku součtu primárních jmenovitých proudů všech hlavních transformátorů nesmí být větší než 1:8.

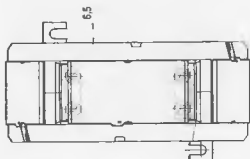
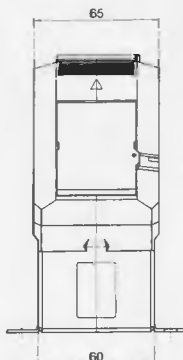
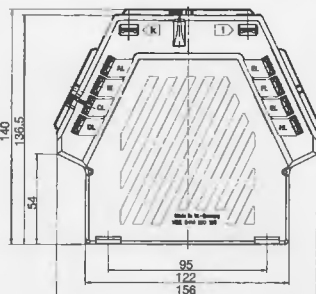

Sčítací transformátory proudu SUSK 4

Primární jmenovitý proud A	Jmenovitý výkon VA	Třída 0,5	Třída 1
		Sekundár 5A Kč	Sekundár 5A Kč
5 + 5 + 5 + 5	5	2400,-	2120,-
	10	2560,-	2290,-
	15	2790,-	2460,-
	25		2680,-
	30		2910,-

Příplatek: primár 1 A - 270 Kč
sekundár 1 A - 270 Kč

Sčítací transformátory proudu SUSK 5

Primární jmenovitý proud A	Jmenovitý výkon VA	Třída 0,5	Třída 1
		Sekundár 5A Kč	Sekundár 5A Kč
5 + 5 + 5 + 5 + 5	5	2680,-	2450,-
	10	2840,-	2560,-
	15	3030,-	2730,-
	30		3120,-

Příplatek: primár 1 A - 270 Kč
sekundár 1 A - 270 Kč

Důležité:

Při objednávání je nutné vždy uvést převod, výkon (VA), třídu přesnosti připojených hlavních transformátorů.

Sčítací transformátory proudu SUSK 6

Primární jmenovitý proud A	Jmenovitý výkon VA	Třída 0,5	Třída 1
		Sekundár 5A	Sekundár 5A
		Kč	Kč
5 + 5 + 5 + 5 + 5 + 5	5	2900,-	2680,-
	10	3060,-	2840,-
	15	3260,-	3010,-
	30		3440,-

Příplatek: primár 1 A - 270 Kč
sekundár 1 A - 270 Kč

Provedení:

Transformátor závitového provedení
s 3 až 8 vzájemně nezávislými primárními
vstupními obvody.

Primární jmenovitý proud 5A příp. 1A
Sekundární jmenovitý proud 5A příp. 1A

Příkon P_0

Sek. 5A $P_0 < 8$ VA
Sek. 1A $P_0 < 5$ VA

Poměr primárního jmenovitého proudu
hlavního transformátoru s nejnižším
převodem ku součtu primárních jmenovi-
tých proudů všech hlavních transformá-
torů nesmí být větší než 1:8.

Sčítací transformátory proudu SUSK 7

Primární jmenovitý proud A	Jmenovitý výkon VA	Třída 0,5	Třída 1
		Sekundár 5A	Sekundár 5A
		Kč	Kč
5 + 5 + 5 + 5 + 5 + 5 + 5	5	3120,-	3010,-
	10	3330,-	3170,-
	15	3580,-	3330,-
	30		3720,-

Příplatek: primár 1 A - 270 Kč
sekundár 1 A - 270 Kč

Sčítací transformátory proudu SUSK 8

Primární jmenovitý proud A	Jmenovitý výkon VA	Třída 0,5	Třída 1
		Sekundár 5A	Sekundár 5A
		Kč	Kč
5 + 5 + 5 + 5 + 5 + 5 + 5 + 5	5	3220,-	3120,-
	10	3440,-	3280,-
	15	3690,-	3440,-
	30		3830,-

Příplatek: primár 1 A - 270 Kč
sekundár 1 A - 270 Kč

Důležité:

Při objednávání je nutné vždy uvést
převod, výkon (VA), třídu přesnosti
připojených hlavních transformátorů.



Zvláštní měřicí transformátory

NH 6.1

NH 6.1/2U

Primární jmenovitý proud A	Jmenovitý výkon VA	Třída 3	
		Sekundár 5A	Sekundár 1A
		Kč	Kč
100	1,25	495,-	585,-
150	2,5	495,-	585,-
200	3,5	495,-	585,-
250	4	495,-	585,-
300	5	495,-	585,-
200-100	2,5-1,25	520,-	610,-
300-150	5-2,5	520,-	610,-

Provedení:

Pro kontaktní měření na nízkonapěťových, výkonových pojistkách 380 V.

Technické údaje:

Velikost 1 podle DIN 43620/1

Primární jmenovitý proud 100A – 300A

Sekundární jmenovitý proud 1A a 5A

Jmenovitý kmitočet 50 – 60 Hz

Transformátor je osazen 2 páry zdířek a může být trvale provozován při odpojené zátěži bez zkratování výstupních zdířek.

Přitom napětí naprázdno při jmenovitém sekundárním proudu 5A nepřesáhne 3-6V a při 1A nepřesáhne 13 – 25 V.

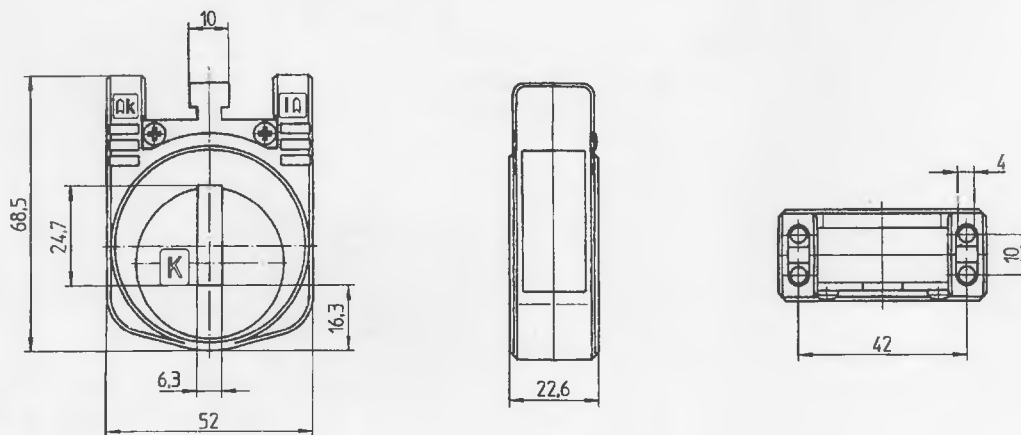



Zvláštní měřicí transformátory

NH 6.2

NH 6.2/2U

Primární jmenovitý proud A	Jmenovitý výkon VA	Třída 3	
		Sekundár 5A	Sekundár 1A
		Kč	Kč
100	1,25	595,-	675,-
150	2,5	595,-	675,-
200	3,5	595,-	675,-
250	4	595,-	675,-
300	5	595,-	675,-
400	5	595,-	675,-
200-100	2,5-1,25	595,-	675,-
300-150	5-2,5	595,-	675,-
400-200	5-2,5	595,-	675,-

Technické údaje:

Velikost 2 podle DIN 43620/1

Primární jmenovitý proud

100A – 400A

Sekundární jmenovitý proud

1A a 5A

Jmenovitý kmitočet

50 – 60 Hz

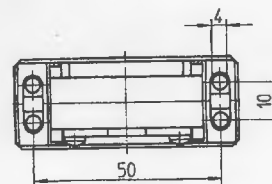
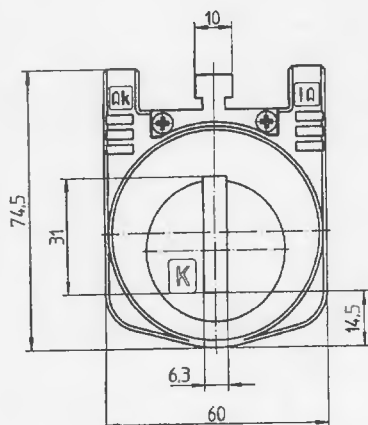



Zvláštní měřicí transformátory

NH 6.3

NH 6.3/2U

Primární jmenovitý proud A	Jmenovitý výkon VA	Třída 3	
		Sekundár 5A Kč	Sekundár 1A Kč
150	2,5	640,-	720,-
200	3,5	640,-	720,-
250	4	640,-	720,-
300	5	640,-	720,-
400	5	640,-	720,-
500	5	640,-	720,-
600	10	640,-	720,-
300-150	5-2,5	660,-	740,-
400-200	5-2,5	660,-	740,-
600-300	5-2,5	660,-	740,-

Technické údaje:

Velikost 3 podle DIN 43620/1

Primární jmenovitý proud

150A – 600A

Sekundární jmenovitý proud

1A a 5A

Jmenovitý kmitočet

50 – 60 Hz

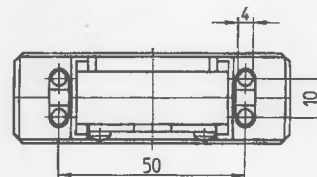
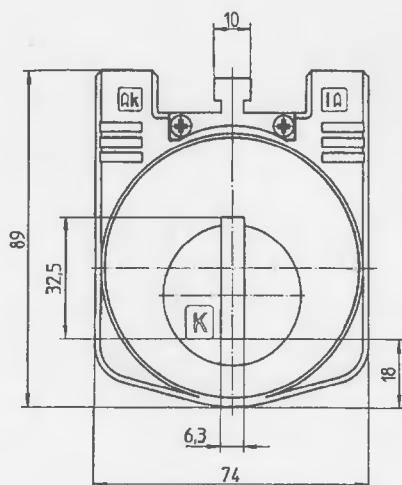

Zvláštní příslušenství



Měděná trubka

Šírka	x	Tloušťka	x	Délka	Maximální proud	Cena/Ks
22,5	x	16,5	x	34 mm	600 A	55,-
22,5	x	16,5	x	36 mm	600 A	60,-
22,5	x	16,5	x	libovolná	600 A	na vyžádání
22,5	x	12,5	x	34 mm	600 A	65,-
22,5	x	12,5	x	36 mm	600 A	68,-
22,5	x	12,5	x	libovolná	600 A	na vyžádání
22,5	x	8,5	x	34 mm	600 A	70,-
22,5	x	8,5	x	36 mm	600 A	75,-
22,2	x	8,5	x	libovolná	600 A	na vyžádání
21,0	x	12,5	x	32 mm	600 A	65,-
21,0	x	12,5	x	34 mm	600 A	68,-
21,0	x	12,5	x	libovolná	600 A	na vyžádání
21,0	x	8,5	x	32 mm	600 A	75,-
21,0	x	8,5	x	34 mm	600 A	80,-
21,0	x	8,5	x	libovolná	600 A	na vyžádání

