



Partida Madrigueres Sud, 63A Naves 1-4
03700 Dénia (Alicante) Spain
Tel: 965 753 083
info@kohl-lighting.com

www.kohl-lighting.com

ÍNDICE - INDEX

K50100	PG. 58	K50225	PG. 35	K50416	PG. 43
K50110	PG. 54	K50226	PG. 35	K50500	PG. 24
K50111	PG. 54	K50230	PG. 36	K50501	PG. 26
K50112	PG. 55	K50231	PG. 36	K50502	PG. 10
K50113	PG. 55	K50232	PG. 37	K50503	PG. 12
K50125	PG. 59	K50233	PG. 37	K50504	PG. 14
K50126	PG. 59	K50300	PG. 50	K50505	PG. 16
K50130	PG. 57	K50301	PG. 50	K50506	PG. 26
K50131	PG. 57	K50302	PG. 50	K50600	PG. 46
K50132	PG. 56	K50303	PG. 50	K50601	PG. 46
K50140	PG. 53	K50310	PG. 40	K50700	PG. 51
K50141	PG. 53	K50311	PG. 40	K50701	PG. 51
K50200	PG. 30	K50312	PG. 40	K52100	PG. 64
K50201	PG. 30	K50313	PG. 40	K52200	PG. 64
K50202	PG. 31	K50315	PG. 41	K52300	PG. 65
K50203	PG. 31	K50316	PG. 41	K52301	PG. 65
K50206	PG. 31	K50317	PG. 41	K52400	PG. 60
K50210	PG. 32	K50318	PG. 41	K52401	PG. 60
K50211	PG. 32	K50400	PG. 44	K52500	PG. 62
K50212	PG. 32	K50401	PG. 44	K52501	PG. 62
K50220	PG. 34	K50405	PG. 42	K52502	PG. 62
K50221	PG. 34	K50406	PG. 42	K52600	PG. 66
K50222	PG. 35	K50410	PG. 45	K52601	PG. 66
K50223	PG. 35	K50411	PG. 45	K52602	PG. 66
K50224	PG. 35	K50415	PG. 43	K52603	PG. 67

K52604	PG. 67	K55002	PG. 68	KACRGB3	PG. 74
K52605	PG. 67	K55003	PG. 69	KACRGB4	PG. 74
K53250	PG. 39	K55004	PG. 69	KACRGB5	PG. 74
K53251	PG. 39	K55005	PG. 70	KACRGBW1	PG. 74
K53252	PG. 39	K55006	PG. 70	KB	PG. 72
K53260	PG. 38	K55007	PG. 70	KD55100	PG. 73
K53261	PG. 38	K55008	PG. 69	KD55101	PG. 73
K53262	PG. 38	KAC50500	PG. 28	KD55105	PG. 73
K53265	PG. 52	KAC50501	PG. 28	KDFLEX1	PG. 73
K53266	PG. 52	KAC50502	PG. 18	KP50001	PG. 71
K53267	PG. 52	KAC50503	PG. 18	KP50002	PG. 71
K53270	PG. 48	KACFLEX1	PG. 73	KP50003	PG. 71
K53271	PG. 49	KACFLEX2	PG. 73		
K55000	PG. 68	KACRGB1	PG. 74		
K55001	PG. 68	KACRGB2	PG. 74		

ÍNDICE

INDEX

LED PANEL - PANEL LED



10 WINNER



12 WINNER



14 ELITE

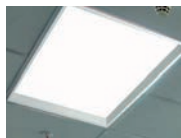

16 ELITE



24 CHESS



26 CHESS



27 CHESS

LED INTEGRADO - INTEGRATED LED



30 DISC



32 DISC SQUARE



34 DISC SURFACE



36 DISC SQUARE SURFACE



38 MARJAL



39 MARJAL SQUARE



40 LIM ROUND



41 LIM SQUARE



42 TINA ROUND



43 TINA SQUARE



44 CIRQUE



45 CORNER



46 TINY ROUND



46 TINY SQUARE



48 REBECCA



49 REBECCA SQUARE



50 DARA



51 LASSO



52 DETEK

GU10



53 SUN



53 DAWN



54 MOON



54 VENUS



55 OZONE



55 DIP



56 DAISY



57 DOT



57 DASH



58 FOCUS



59 SAT ROUND



59 SAT SQUARE

EXTERIOR - OUTDOOR



60 BOLETUS



62 TOWER



64 MAILBOX



64 HUNTER



65 HAMMER ROUND



65 HAMMER SQUARE



66 STORM

TIRAS DE LED - LED STRIP



68 TIRAS LED
LED STRIP



71 PERFILES
PROFILES

TÉCNICA - TECHNICAL



72 KB



73 DIMMER



73 ACCESORIOS



74 RGB ACCESORIOS



ENVÍOS EXPRESS
FAST DELIVERY







WINNER

REF. K50502



IP/20



INC.



○ 37W **3000K** CRI≥80 900 mA 50.000h

K50502.W.OP.3K	3589 lm	OPAL	NO DIM
K50502.W.OP.3K.DA	3589 lm	OPAL	DALI
K50502.W.OP.3K.PU	3589 lm	OPAL	PUSH
K50502.W.OP.3K.D1	3589 lm	OPAL	1..10V
K50502.W.MP.3K	3441 lm	MP	NO DIM
K50502.W.MP.3K.DA	3441 lm	MP	DALI
K50502.W.MP.3K.PU	3441 lm	MP	PUSH
K50502.W.MP.3K.D1	3441 lm	MP	1..10V



○ 37W **4000K** CRI≥80 900 mA 50.000h

K50502.W.OP.4K	3885 lm	OPAL	NO DIM
K50502.W.OP.4K.DA	3885 lm	OPAL	DALI
K50502.W.OP.4K.PU	3885 lm	OPAL	PUSH
K50502.W.OP.4K.D1	3885 lm	OPAL	1..10V
K50502.W.MP.4K	3700 lm	MP	NO DIM
K50502.W.MP.4K.DA	3700 lm	MP	DALI
K50502.W.MP.4K.PU	3700 lm	MP	PUSH
K50502.W.MP.4K.D1	3700 lm	MP	1..10V

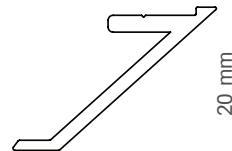
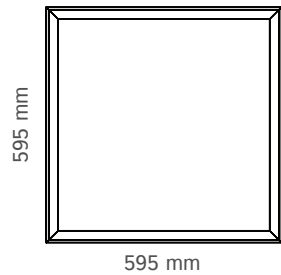

○ 37W **6000K** CRI≥80 900 mA 50.000h

K50502.W.OP.6K	4000 lm	OPAL	NO DIM
K50502.W.OP.6K.DA	4000 lm	OPAL	DALI
K50502.W.OP.6K.PU	4000 lm	OPAL	PUSH
K50502.W.OP.6K.D1	4000 lm	OPAL	1..10V
K50502.W.MP.6K	3774 lm	MP	NO DIM
K50502.W.MP.6K.DA	3774 lm	MP	DALI
K50502.W.MP.6K.PU	3774 lm	MP	PUSH
K50502.W.MP.6K.D1	3774 lm	MP	1..10V

OPAL MICROPRISMÁTICO

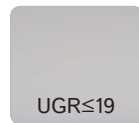

DRIVER PHILIPS



(NO DIM)

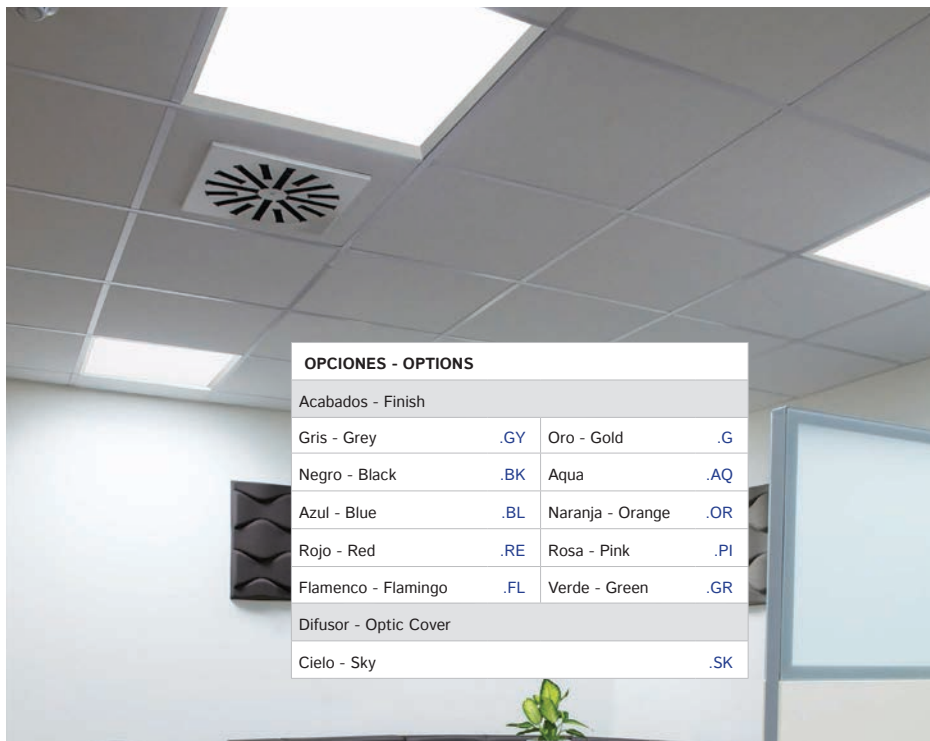
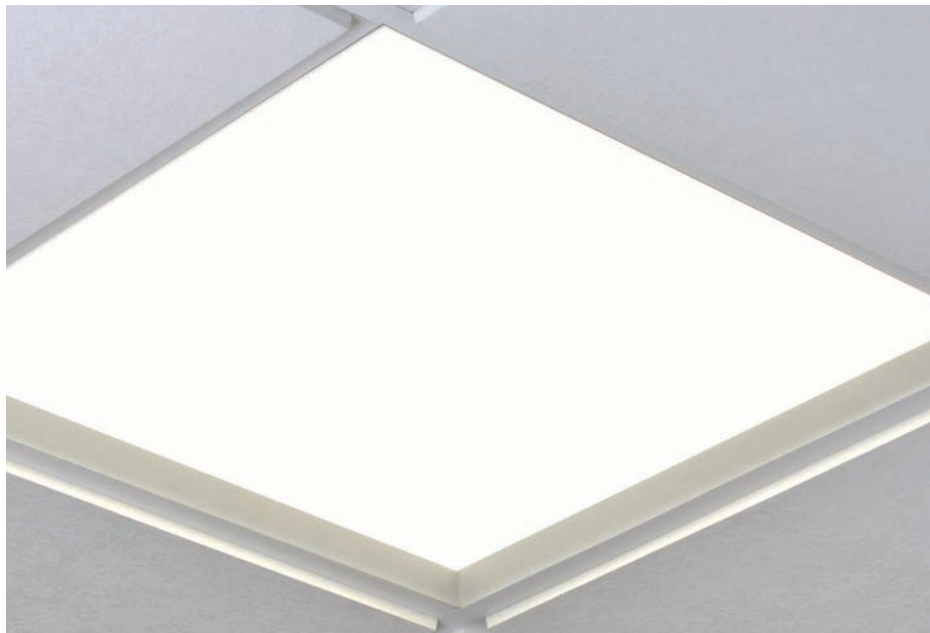

OPCIONES - OPTIONS

Acabados - Finish

Gris - Grey	.GY	Oro - Gold	.G
Negro - Black	.BK	Aqua	.AQ
Azul - Blue	.BL	Naranja - Orange	.OR
Rojo - Red	.RE	Rosa - Pink	.PI
Flamenco - Flamingo	.FL	Verde - Green	.GR

Difusor - Optic Cover

Cielo - Sky	.SK
-------------	-----

WINNER

REF. K50503



IP/20



INC.



72W 3000K CRI≥80 900 mA 50.000h

K50503.W.OP.3K	5616 lm	OPAL	NO DIM
K50503.W.OP.3K.DA	5616 lm	OPAL	DALI
K50503.W.OP.3K.PU	5616 lm	OPAL	PUSH
K50503.W.OP.3K.D1	5616 lm	OPAL	1..10V
K50503.W.MP.3K	5328 lm	MP	NO DIM
K50503.W.MP.3K.DA	5328 lm	MP	DALI
K50503.W.MP.3K.PU	5328 lm	MP	PUSH
K50503.W.MP.3K.D1	5328 lm	MP	1..10V

72W 4000K CRI≥80 900 mA 50.000h

K50503.W.OP.4K	6264 lm	OPAL	NO DIM
K50503.W.OP.4K.DA	6264 lm	OPAL	DALI
K50503.W.OP.4K.PU	6264 lm	OPAL	PUSH
K50503.W.OP.4K.D1	6264 lm	OPAL	1..10V
K50503.W.MP.4K	6048 lm	MP	NO DIM
K50503.W.MP.4K.DA	6048 lm	MP	DALI
K50503.W.MP.4K.PU	6048 lm	MP	PUSH
K50503.W.MP.4K.D1	6048 lm	MP	1..10V

72W 6000K CRI≥80 900 mA 50.000h

K50503.W.OP.6K	6264 lm	OPAL	NO DIM
K50503.W.OP.6K.DA	6264 lm	OPAL	DALI
K50503.W.OP.6K.PU	6264 lm	OPAL	PUSH
K50503.W.OP.6K.D1	6264 lm	OPAL	1..10V
K50503.W.MP.6K	6192 lm	MP	NO DIM
K50503.W.MP.6K.DA	6192 lm	MP	DALI
K50503.W.MP.6K.PU	6192 lm	MP	PUSH
K50503.W.MP.6K.D1	6192 lm	MP	1..10V

595 mm

1195 mm

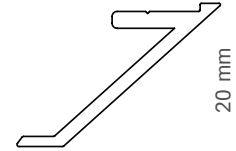
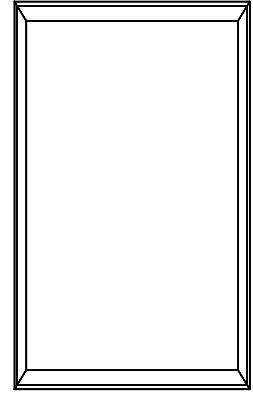

20 mm

OPAL

MICROPRISMÁTICO



UGR≤19



UGR≤17

DRIVER PHILIPS



(NO DIM)

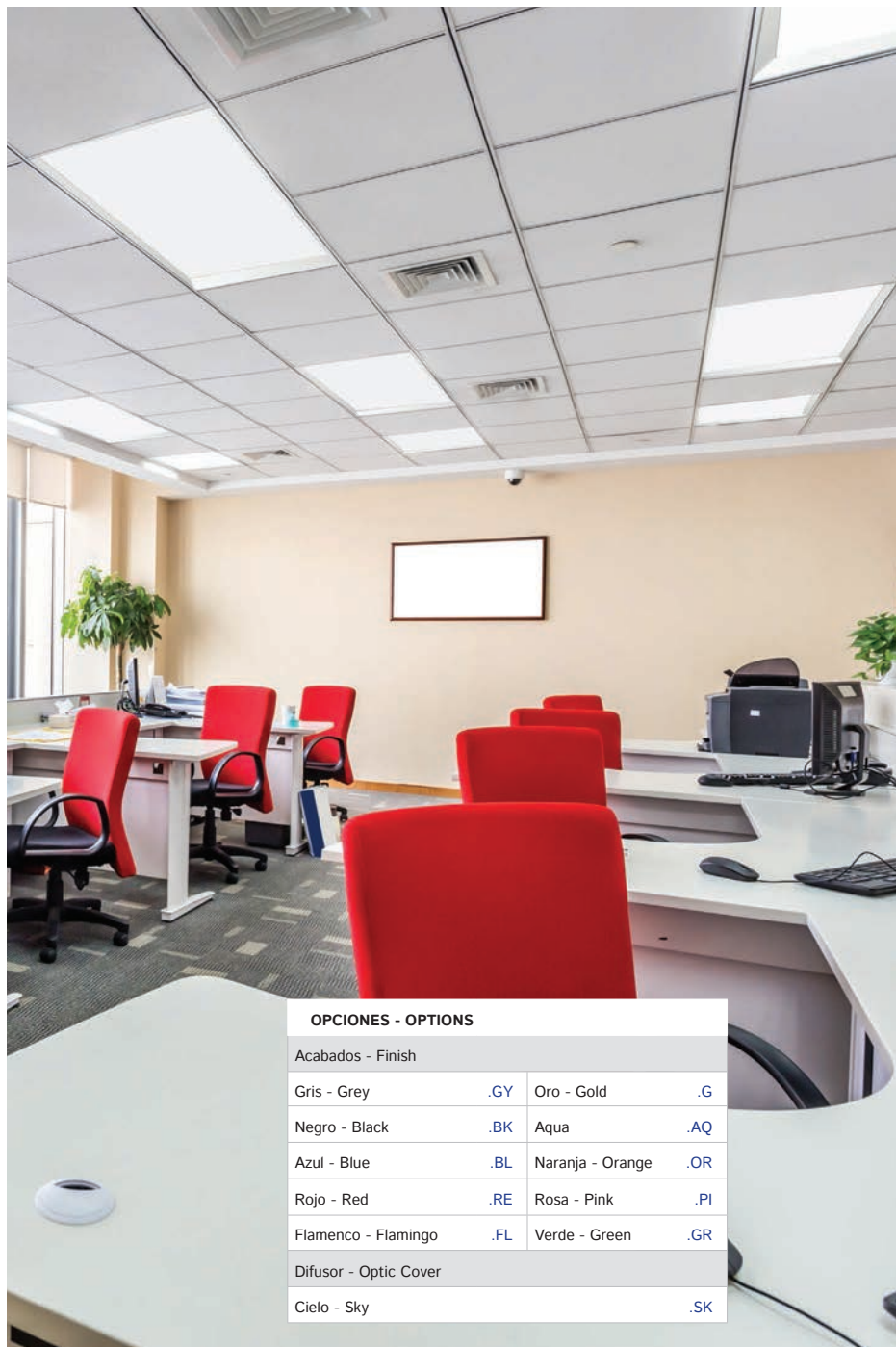

OPCIONES - OPTIONS

Acabados - Finish

Gris - Grey	.GY	Oro - Gold	.G
Negro - Black	.BK	Aqua	.AQ
Azul - Blue	.BL	Naranja - Orange	.OR
Rojo - Red	.RE	Rosa - Pink	.PI
Flamenco - Flamingo	.FL	Verde - Green	.GR
Difusor - Optic Cover			
Cielo - Sky			.SK

ELITE

REF. K50504



IP/20



INC.



○ 37W **3000K** CRI≥80 900 mA 50.000h

K50504.W.OP.3K	3589 lm	OPAL	NO DIM
K50504.W.OP.3K.DA	3589 lm	OPAL	DALI
K50504.W.OP.3K.PU	3589 lm	OPAL	PUSH
K50504.W.OP.3K.D1	3589 lm	OPAL	1..10V
K50504.W.MP.3K	3441 lm	MP	NO DIM
K50504.W.MP.3K.DA	3441 lm	MP	DALI
K50504.W.MP.3K.PU	3441 lm	MP	PUSH
K50504.W.MP.3K.D1	3441 lm	MP	1..10V



○ 37W **4000K** CRI≥80 900 mA 50.000h

K50504.W.OP.4K	3885 lm	OPAL	NO DIM
K50504.W.OP.4K.DA	3885 lm	OPAL	DALI
K50504.W.OP.4K.PU	3885 lm	OPAL	PUSH
K50504.W.OP.4K.D1	3885 lm	OPAL	1..10V
K50504.W.MP.4K	3700 lm	MP	NO DIM
K50504.W.MP.4K.DA	3700 lm	MP	DALI
K50504.W.MP.4K.PU	3700 lm	MP	PUSH
K50504.W.MP.4K.D1	3700 lm	MP	1..10V

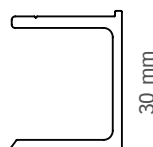
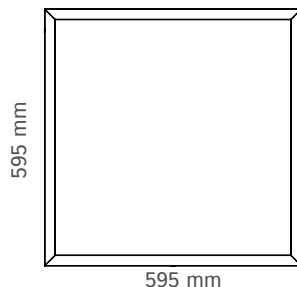

○ 37W **6000K** CRI≥80 900 mA 50.000h

K50504.W.OP.6K	4000 lm	OPAL	NO DIM
K50504.W.OP.6K.DA	4000 lm	OPAL	DALI
K50504.W.OP.6K.PU	4000 lm	OPAL	PUSH
K50504.W.OP.6K.D1	4000 lm	OPAL	1..10V
K50504.W.MP.6K	3774 lm	MP	NO DIM
K50504.W.MP.6K.DA	3774 lm	MP	DALI
K50504.W.MP.6K.PU	3774 lm	MP	PUSH
K50504.W.MP.6K.D1	3774 lm	MP	1..10V

OPAL MICROPRISMÁTICO

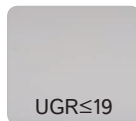

DRIVER PHILIPS



(NO DIM)

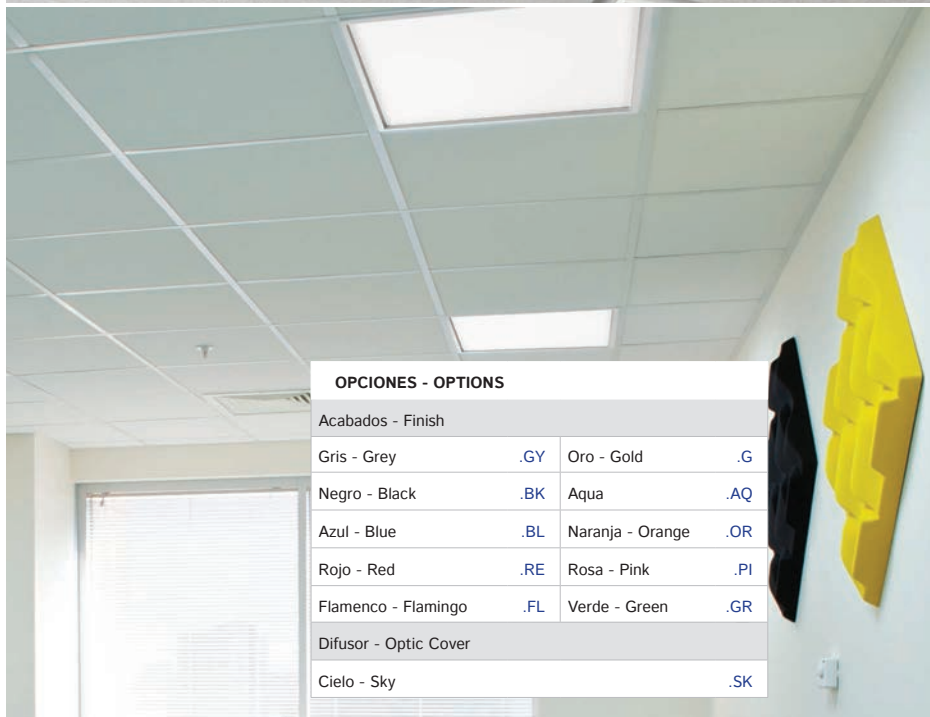

OPCIONES - OPTIONS			
Acabados - Finish			
Gris - Grey	.GY	Oro - Gold	.G
Negro - Black	.BK	Aqua	.AQ
Azul - Blue	.BL	Naranja - Orange	.OR
Rojo - Red	.RE	Rosa - Pink	.PI
Flamenco - Flamingo	.FL	Verde - Green	.GR
Difusor - Optic Cover			
Cielo - Sky			.SK

ELITE

REF. K50505



IP/20



INC.



○ 72W **3000K** CRI≥80 900 mA 50.000h

K50505.W.OP.3K	5616 lm	OPAL	NO DIM
K50505.W.OP.3K.DA	5616 lm	OPAL	DALI
K50505.W.OP.3K.PU	5616 lm	OPAL	PUSH
K50505.W.OP.3K.D1	5616 lm	OPAL	1..10V
K50505.W.MP.3K	5328 lm	MP	NO DIM
K50505.W.MP.3K.DA	5328 lm	MP	DALI
K50505.W.MP.3K.PU	5328 lm	MP	PUSH
K50505.W.MP.3K.D1	5328 lm	MP	1..10V

OPAL

MICROPRISMÁTICO

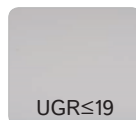

DRIVER PHILIPS



(NO DIM)

595 mm

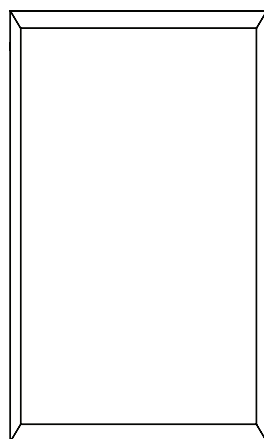

1195 mm

30 mm

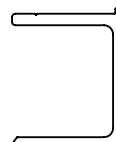

○ 72W **4000K** CRI≥80 900 mA 50.000h

K50505.W.OP.4K	6264 lm	OPAL	NO DIM
K50505.W.OP.4K.DA	6264 lm	OPAL	DALI
K50505.W.OP.4K.PU	6264 lm	OPAL	PUSH
K50505.W.OP.4K.D1	6264 lm	OPAL	1..10V
K50505.W.MP.4K	6048 lm	MP	NO DIM
K50505.W.MP.4K.DA	6048 lm	MP	DALI
K50505.W.MP.4K.PU	6048 lm	MP	PUSH
K50505.W.MP.4K.D1	6048 lm	MP	1..10V

○ 72W **6000K** CRI≥80 900 mA 50.000h

K50505.W.OP.6K	6264 lm	OPAL	NO DIM
K50505.W.OP.6K.DA	6264 lm	OPAL	DALI
K50505.W.OP.6K.PU	6264 lm	OPAL	PUSH
K50505.W.OP.6K.D1	6264 lm	OPAL	1..10V
K50505.W.MP.6K	6192 lm	MP	NO DIM
K50505.W.MP.6K.DA	6192 lm	MP	DALI
K50505.W.MP.6K.PU	6192 lm	MP	PUSH
K50505.W.MP.6K.D1	6192 lm	MP	1..10V

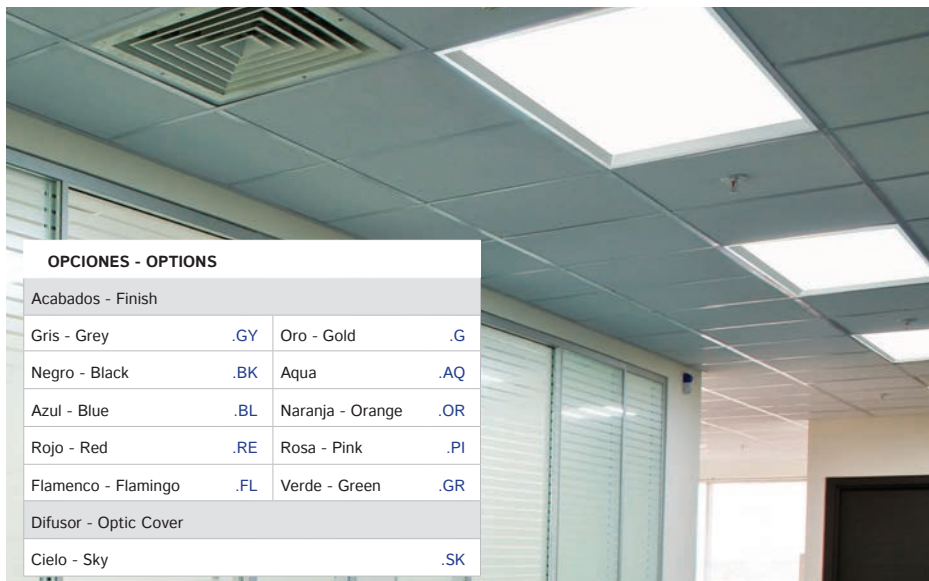

OPCIONES - OPTIONS

Acabados - Finish

Gris - Grey .GY Oro - Gold .G

Negro - Black .BK Aqua .AQ

Azul - Blue .BL Naranja - Orange .OR

Rojo - Red .RE Rosa - Pink .PI

Flamenco - Flamingo .FL Verde - Green .GR

Difusor - Optic Cover

Cielo - Sky .SK

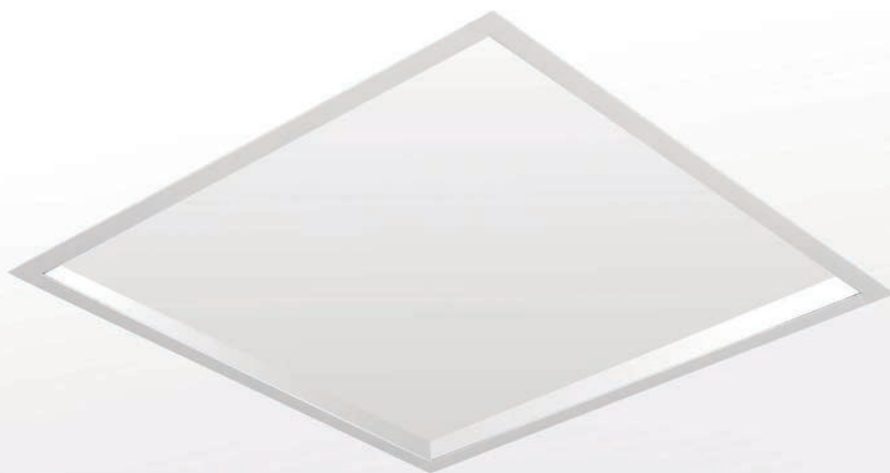

50504 + KAC50504.RF

WINNER - ELITE

ACCESORIOS - ACCESSORIES

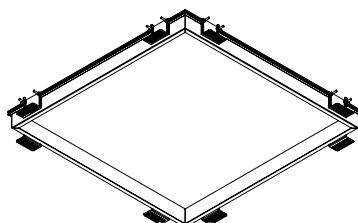
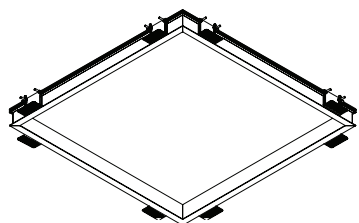

EMPOTRADO MARCO - RECESSED WITH FRAME

KAC50502.RF	595x595 mm
KAC50503.RF	1195x595 mm

EMPOTRADO SIN MARCO - TRIMLESS

KAC50502.TR	595x595 mm
KAC50503.TR	1195x595 mm

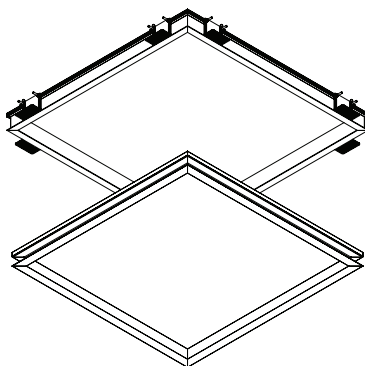
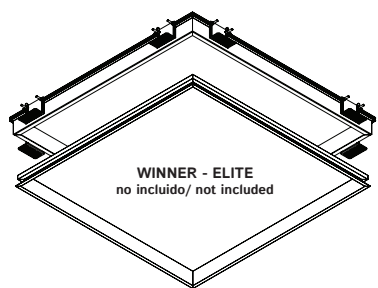

CARACTERÍSTICAS - FEATURES

Difusor - Optic Cover

OPAL

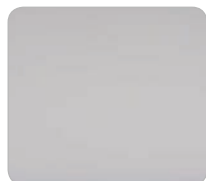

UGR≤19

MICROPRISMÁTICO

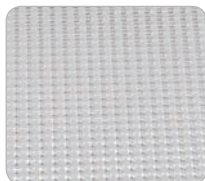

UGR≤17

CIELO - SKY



DRIVER



DRIVER PHILIPS

38W 220-240V 50/60HZ 900 mA

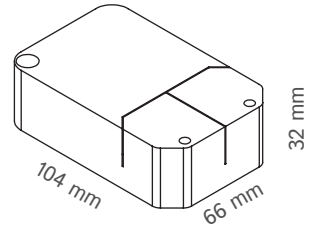

CODIFICACIÓN DE COLORES - COLORS CODE

Azul - Blue RAL 5022 .BL	Flamenco - Flamingo RAL 3018 .FL
Aqua RAL 5021 .AQ	Rojo - Red RAL 3000 .RE
Verde - Green RAL 6018 .GR	Rosa - Pink RAL 3014 .PI
Negro - Black RAL 9005 .BK	Naranja - Orange RAL 2004 .OR
Gris - Grey RAL 9006 .GY	Oro - Gold SG25 .G
Blanco - White RAL 9003 .W	

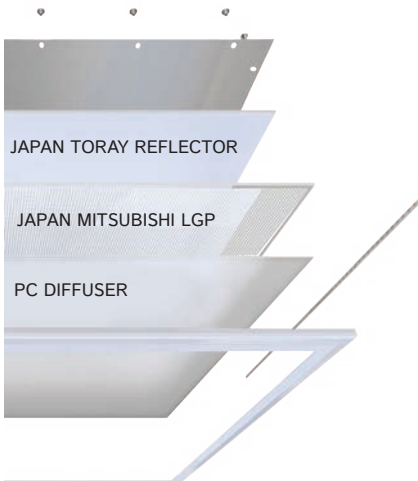

CONTROLADOR CAMBIO DE TEMPERATURA DE COLOR DYNAMIC WHITE

WINNER - ELITE - CHESS

1 PANEL



MANDO A DISTANCIA -
REMOTE CONTROL

Blanco cálido
Warm White

3399lm



Blanco natural
Natural White

4202lm



Blanco frío
Cool White

3655lm

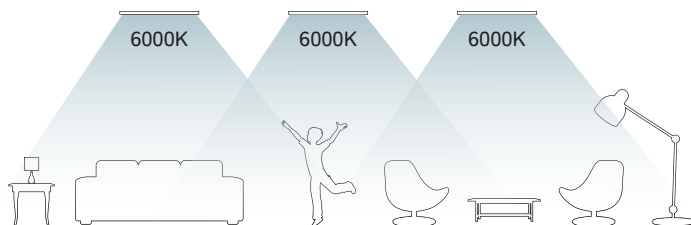
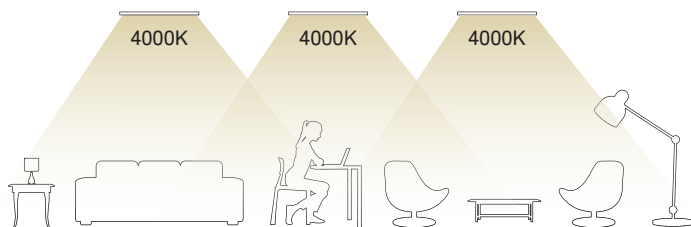
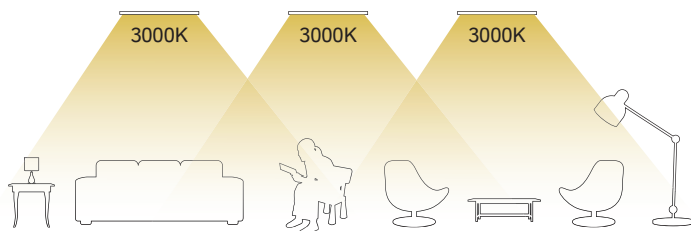

CAMBIO DE TEMPERATURA DE COLOR / *DYNAMIC WHITE*

WINNER - ELITE - CHESS

WINNER	K50502.W.OP.WT	40W · OPAL · 2900K-5500K · 595x595 mm
	K50503.W.OP.WT	55W · OPAL · 2900K-5500K · 1295x595 mm
ELITE	K50504.W.OP.WT	40W · OPAL · 2900K-5500K · 595x595 mm
	K50505.W.OP.WT	55W · OPAL · 2900K-5500K · 1295x595 mm
CHESS	K50500.W.OP.WT	40W · OPAL · 2900K-5500K · 595x595 mm
	K50501.W.OP.WT	55W · OPAL · 2900K-5500K · 1295x595 mm

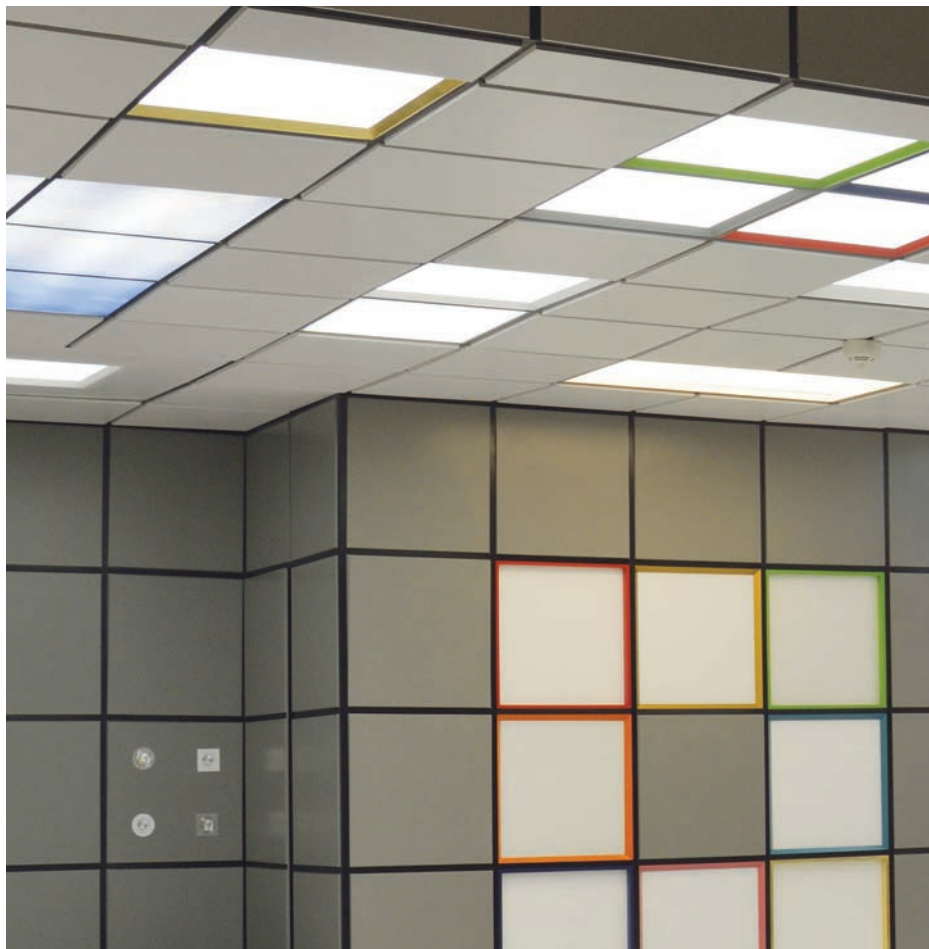





CHESS

REF. K50500



○ 37W **3000K** CRI≥80 900 mA 50.000h

Model	Light Output (lm)	Beam Spread	Dimming
K50500.W.OP.3K	3589	OPAL	NO DIM
K50500.W.OP.3K.DA	3589	OPAL	DALI
K50500.W.OP.3K.PU	3589	OPAL	PUSH
K50500.W.OP.3K.D1	3589	OPAL	1..10V
K50500.W.MP.3K	3441	MP	NO DIM
K50500.W.MP.3K.DA	3441	MP	DALI
K50500.W.MP.3K.PU	3441	MP	PUSH
K50500.W.MP.3K.D1	3441	MP	1..10V

OPAL

MICROPRISMÁTICO

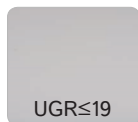

DRIVER PHILIPS



(NO DIM)

○ 37W **4000K** CRI≥80 900 mA 50.000h

Model	Light Output (lm)	Beam Spread	Dimming
K50500.W.OP.4K	3885	OPAL	NO DIM
K50500.W.OP.4K.DA	3885	OPAL	DALI
K50500.W.OP.4K.PU	3885	OPAL	PUSH
K50500.W.OP.4K.D1	3885	OPAL	1..10V
K50500.W.MP.4K	3700	MP	NO DIM
K50500.W.MP.4K.DA	3700	MP	DALI
K50500.W.MP.4K.PU	3700	MP	PUSH
K50500.W.MP.4K.D1	3700	MP	1..10V

595 mm

11 mm

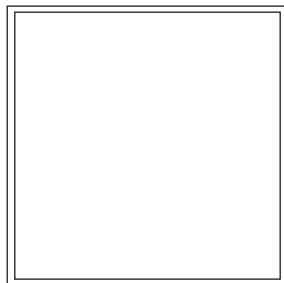

○ 37W **6000K** CRI≥80 900 mA 50.000h

Model	Light Output (lm)	Beam Spread	Dimming
K50500.W.OP.6K	4000	OPAL	NO DIM
K50500.W.OP.6K.DA	4000	OPAL	DALI
K50500.W.OP.6K.PU	4000	OPAL	PUSH
K50500.W.OP.6K.D1	4000	OPAL	1..10V
K50500.W.MP.6K	3774	MP	NO DIM
K50500.W.MP.6K.DA	3774	MP	DALI
K50500.W.MP.6K.PU	3774	MP	PUSH
K50500.W.MP.6K.D1	3774	MP	1..10V



CHESS

REF. K50506



IP
20



INC.

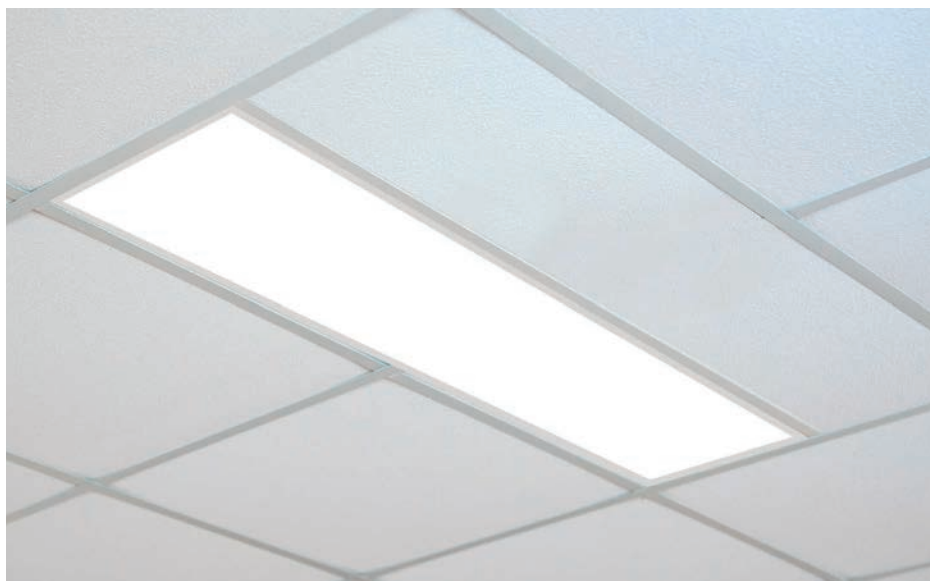

○ 37W **3000K** CRI≥80 900 mA 50.000h

K50506.W.OP.3K	3589 lm	OPAL	NO DIM
K50506.W.OP.3K.DA	3589 lm	OPAL	DALI
K50506.W.OP.3K.PU	3589 lm	OPAL	PUSH
K50506.W.OP.3K.D1	3589 lm	OPAL	1..10V

○ 37W **4000K** CRI≥80 900 mA 50.000h

K50506.W.OP.4K	3885 lm	OPAL	NO DIM
K50506.W.OP.4K.DA	3885 lm	OPAL	DALI
K50506.W.OP.4K.PU	3885 lm	OPAL	PUSH
K50506.W.OP.4K.D1	3885 lm	OPAL	1..10V

○ 37W **6000K** CRI≥80 900 mA 50.000h

K50506.W.OP.6K	4000 lm	OPAL	NO DIM
K50506.W.OP.6K.DA	4000 lm	OPAL	DALI
K50506.W.OP.6K.PU	4000 lm	OPAL	PUSH
K50506.W.OP.6K.D1	4000 lm	OPAL	1..10V

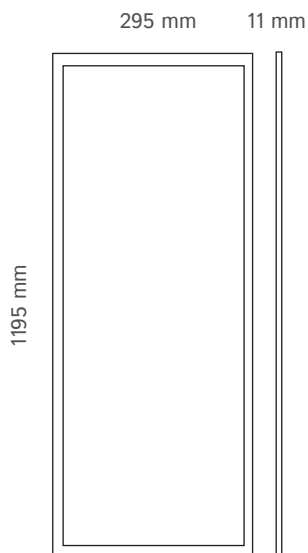

CHESS

REF. K50501



IP/20



INC.



72W 3000K CRI≥80 900 mA 50.000h

K50501.W.OP.3K	5616 lm	OPAL	NO DIM
K50501.W.OP.3K.DA	5616 lm	OPAL	DALI
K50501.W.OP.3K.PU	5616 lm	OPAL	PUSH
K50501.W.OP.3K.D1	5616 lm	OPAL	1..10V
K50501.W.MP.3K	5328 lm	MP	NO DIM
K50501.W.MP.3K.DA	5328 lm	MP	DALI
K50501.W.MP.3K.PU	5328 lm	MP	PUSH
K50501.W.MP.3K.D1	5328 lm	MP	1..10V

72W 4000K CRI≥80 900 mA 50.000h

K50501.W.OP.4K	6264 lm	OPAL	NO DIM
K50501.W.OP.4K.DA	6264 lm	OPAL	DALI
K50501.W.OP.4K.PU	6264 lm	OPAL	PUSH
K50501.W.OP.4K.D1	6264 lm	OPAL	1..10V
K50501.W.MP.4K	6048 lm	MP	NO DIM
K50501.W.MP.4K.DA	6048 lm	MP	DALI
K50501.W.MP.4K.PU	6048 lm	MP	PUSH
K50501.W.MP.4K.D1	6048 lm	MP	1..10V

72W 6000K CRI≥80 900 mA 50.000h

K50501.W.OP.6K	6264 lm	OPAL	NO DIM
K50501.W.OP.6K.DA	6264 lm	OPAL	DALI
K50501.W.OP.6K.PU	6264 lm	OPAL	PUSH
K50501.W.OP.6K.D1	6264 lm	OPAL	1..10V
K50501.W.MP.6K	6192 lm	MP	NO DIM
K50501.W.MP.6K.DA	6192 lm	MP	DALI
K50501.W.MP.6K.PU	6192 lm	MP	PUSH
K50501.W.MP.6K.D1	6192 lm	MP	1..10V

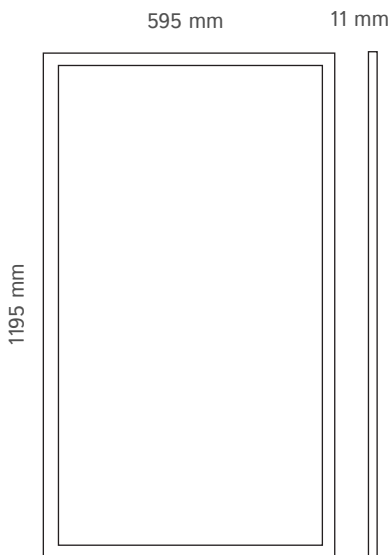

OPAL MICROPRISMÁTICO

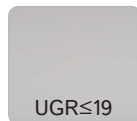

DRIVER PHILIPS



(NO DIM)

CHESS

ACCESORIOS- ACCESSORIES

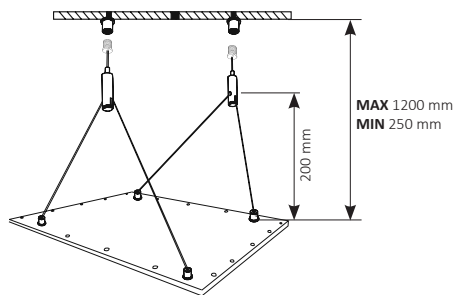

COLGANTE - PENDANT

KAC50500.PN 595x595 mm

KAC50501.PN 1195x595 mm

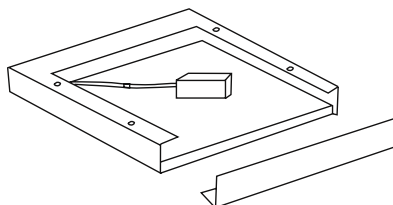

SUPERFICIE - SURFACE

KAC50500.SR 595x595 mm



EMPOTRADO MARCO - RECESSED WITH FRAME

KAC50500.RF 595x595 mm

KAC50501.RF 1195x595 mm

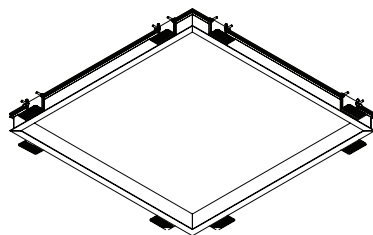

EMPOTRADO MARCO - RECESSED WITH FRAME

KAC50502.RF 595x595 mm

KAC50503.RF 1195x595 mm

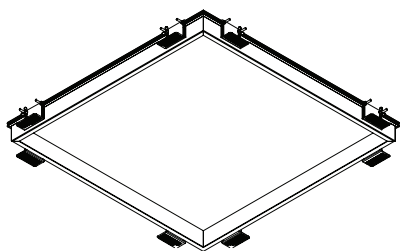

EMPOTRADO SIN MARCO - TRIMLESS

KAC50502.TR 595x595 mm

KAC50503.TR 1195x595 mm

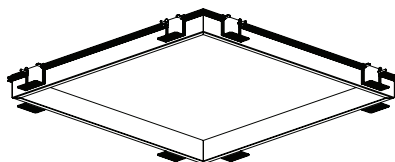

CHESS
no include/ not included

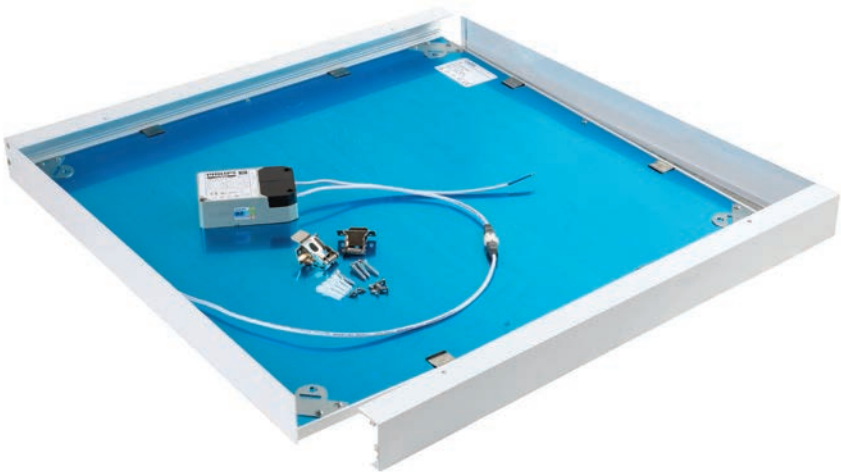

DISC

REF. K50200-K50206



IP
30



INC.



Ø120x17mm

8W · Ø108mm · CRI≥80 · 300 mA · 35.000h

K50200.W.3K	360 lm	3000K	BLANCO - WHITE
K50200.W.4K	464 lm	4000K	BLANCO - WHITE
K50200.W.6K	480 lm	6000K	BLANCO - WHITE



Ø172x17mm

15W · Ø155mm · CRI≥80 · 300mA · 35.000h

K50201.W.3K	1080 lm	3000K	BLANCO - WHITE
K50201.W.4K	1125 lm	4000K	BLANCO - WHITE
K50201.W.6K	1155 lm	6000K	BLANCO - WHITE

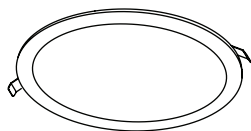

Ø225x17mm

20W · \varnothing Ø205mm · CRI≥80 · 300mA · 35.000h

K50202.W.3K	1500 lm	3000K	BLANCO - WHITE
K50202.W.4K	1560 lm	4000K	BLANCO - WHITE
K50202.W.6K	1600 lm	6000K	BLANCO - WHITE

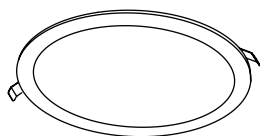

Ø300x17mm

24W · \varnothing Ø280mm · CRI≥80 · 300mA · 35.000h

K50203.W.3K	1800 lm	3000K	BLANCO - WHITE
K50203.W.4K	1872 lm	4000K	BLANCO - WHITE
K50203.W.6K	1920 lm	6000K	BLANCO - WHITE

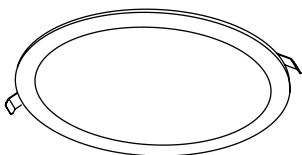

Ø600x17mm

48W · \varnothing Ø585mm · CRI≥80 · 1200mA · 35.000h

K50206.W.3K	3600 lm	3000K	BLANCO - WHITE
K50206.W.4K	3744 lm	4000K	BLANCO - WHITE
K50206.W.6K	3840 lm	6000K	BLANCO - WHITE

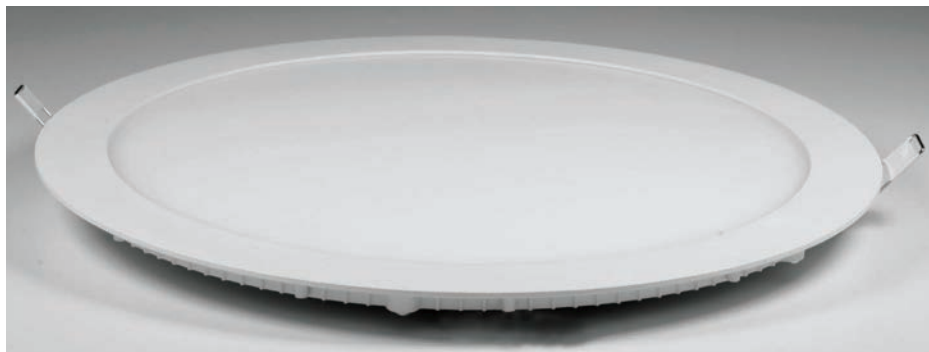

DISC SQUARE

REF. K50210 - K50212

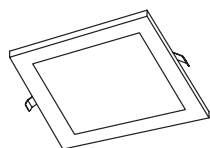

120x120x17mm

8W · 106x106mm · CRI≥80 · 300 mA · 35.000h

K50210.W.3K	360 lm	3000K	BLANCO - WHITE
K50210.W.4K	464 lm	4000K	BLANCO - WHITE
K50210.W.6K	480 lm	6000K	BLANCO - WHITE

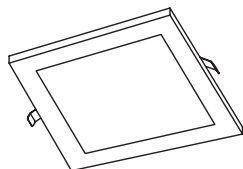

171x171x17mm

15W · 155x155mm · CRI≥80 · 300 mA · 35.000h

K50211.W.3K	1125 lm	3000K	BLANCO - WHITE
K50211.W.4K	1155 lm	4000K	BLANCO - WHITE
K50211.W.6K	1080 lm	6000K	BLANCO - WHITE

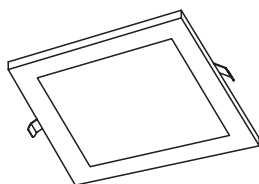

225x225x17mm

20W · 205x205mm · CRI≥80 · 300 mA · 35.000h

K50212.W.3K	1500 lm	3000K	BLANCO - WHITE
K50212.W.4K	1560 lm	4000K	BLANCO - WHITE
K50212.W.6K	1600 lm	6000K	BLANCO - WHITE



DISC SURFACE

REF. K50220 - K50226



IP
30



INC.



Ø120x35mm

8W · CRI≥80 · 300 mA · 35.000h

K50220.W.3K	360 lm	3000K	BLANCO - WHITE
K50220.W.4K	464 lm	4000K	BLANCO - WHITE
K50220.W.6K	480 lm	6000K	BLANCO - WHITE



Ø172x35mm

15W · CRI≥80 · 300mA · 35.000h

K50221.W.3K	1080 lm	3000K	BLANCO - WHITE
K50221.W.4K	1125 lm	4000K	BLANCO - WHITE
K50221.W.6K	1155 lm	6000K	BLANCO - WHITE



Ø225x35mm

20W · CRI≥80 · 300mA · 35.000h

K50222.W.3K	1500 lm	3000K	BLANCO - WHITE
K50222.W.4K	1560 lm	4000K	BLANCO - WHITE
K50222.W.6K	1600 lm	6000K	BLANCO - WHITE



Ø300x35mm

24W · CRI≥80 · 300mA · 35.000h

K50223.W.3K	1800 lm	3000K	BLANCO - WHITE
K50223.W.4K	1872 lm	4000K	BLANCO - WHITE
K50223.W.6K	1920 lm	6000K	BLANCO - WHITE

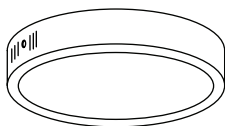

Ø400x35mm

30W · CRI≥80 · 300mA · 35.000h

K50224.W.3K	2250 lm	3000K	BLANCO - WHITE
K50224.W.4K	2340 lm	4000K	BLANCO - WHITE
K50224.W.6K	2400 lm	6000K	BLANCO - WHITE

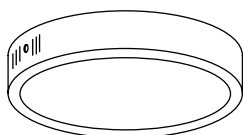

Ø500x35mm

36W · CRI≥80 · 300mA · 35.000h

K50225.W.3K	2700 lm	3000K	BLANCO - WHITE
K50225.W.4K	2808 lm	4000K	BLANCO - WHITE
K50225.W.6K	2880 lm	6000K	BLANCO - WHITE

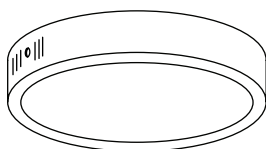

Ø600x35mm

48W · CRI≥80 · 1200mA · 35.000h

K50226.W.3K	3600 lm	3000K	BLANCO - WHITE
K50226.W.4K	3744 lm	4000K	BLANCO - WHITE
K50226.W.6K	3840 lm	6000K	BLANCO - WHITE

DISC SQUARE SURFACE

REF. K50230 - K50233

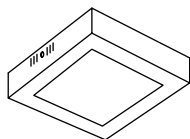

120x120x35mm

8W · CRI≥80 · 300 mA · 35.000h

K50230.W.3K	360 lm	3000K	BLANCO - WHITE
K50230.W.4K	464 lm	4000K	BLANCO - WHITE
K50230.W.6K	480 lm	6000K	BLANCO - WHITE

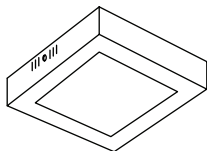

172x172x35mm

15W · CRI≥80 · 300mA · 35.000h

K50231.W.3K	1080 lm	3000K	BLANCO - WHITE
K50231.W.4K	1125 lm	4000K	BLANCO - WHITE
K50231.W.6K	1155 lm	6000K	BLANCO - WHITE

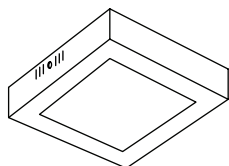

225x225x35mm

20W · CRI≥80 · 300mA · 35.000h

K50232.W.3K	1500 lm	3000K	BLANCO - WHITE
K50232.W.4K	1560 lm	4000K	BLANCO - WHITE
K50232.W.6K	1600 lm	6000K	BLANCO - WHITE

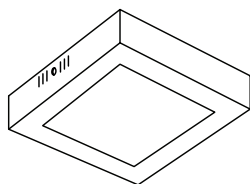

300x300x35mm

24W · CRI≥80 · 300mA · 35.000h

K50233.W.3K	1800 lm	3000K	BLANCO - WHITE
K50233.W.4K	1872 lm	4000K	BLANCO - WHITE
K50233.W.6K	1920 lm	6000K	BLANCO - WHITE



MARJAL

REF. K53262 - K53260



IP
44



INC.

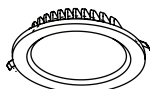

Ø105x60mm

○ 7W · ϕ Ø90mm · CRI≥80 · 350 mA

K53262.W.3K	686 lm	3000K	NO DIM
K53262.W.4K	707 lm	4000K	NO DIM

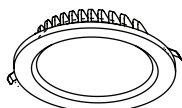

Ø155x60mm

○ 15W · ϕ Ø135mm · CRI≥80 · 350mA

K53261.W.3K	1470 lm	3000K	NO DIM
K53261.W.4K	1515 lm	4000K	NO DIM

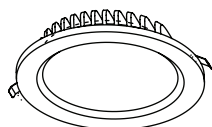

Ø230x60mm

○ 30W · ϕ Ø210mm · CRI≥80 · 700mA

K53260.W.3K	2940 lm	3000K	NO DIM
K53260.W.4K	3030 lm	4000K	NO DIM

MARJAL SQUARE

REF. K53252 - K53250

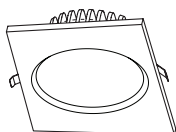

105x105x60mm

○ **7W** · Ø90mm · CRI≥80 · 350 mA

K53252.W.3K	686 lm	3000K	NO DIM
K53252.W.4K	707 lm	4000K	NO DIM

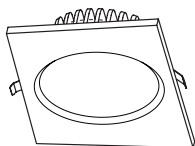

155x155x60mm

○ **15W** · Ø135mm · CRI≥80 · 350mA

K53251.W.3K	1470 lm	3000K	NO DIM
K53251.W.4K	1515 lm	4000K	NO DIM

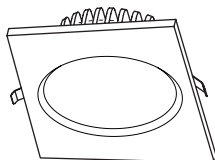

230x230x60mm

○ **30W** · Ø210mm · CRI≥80 · 350mA

K53250.W.3K	2940 lm	3000K	NO DIM
K53250.W.4K	3030 lm	4000K	NO DIM

LIM ROUND

REF. K50310 - K50313



IP
20

CRI
≥80



INC.



3 YEARS
WARRANTY



Ø100x51mm

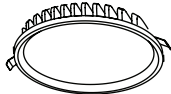

Ø150x69mm

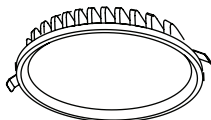

Ø215x78mm

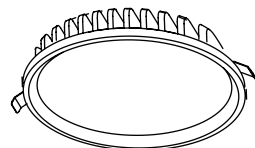

Ø283x83mm

○ **7W** · Ø86mm · 350mA

K50310.W.3K 560 lm 3000K

K50310.W.4K 581 lm 4000K

○ **12W** · Ø136mm · 350mA

K50311.W.3K 960 lm 3000K

K50311.W.4K 996 lm 4000K

○ **25W** · Ø201mm · 700mA

K50312.W.3K 2000 lm 3000K

K50312.W.4K 2075 lm 4000K

○ **35W** · Ø266mm · 700mA

K50313.W.3K 2800 lm 3000K

K50313.W.4K 2905 lm 4000K

LIM SQUARE

REF. K50315 - K50318



IP 20 CRI ≥80



3 YEARS WARRANTY

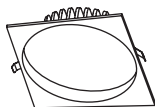

100x100x51mm



150x150x69mm

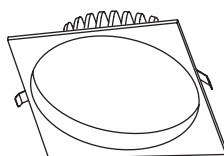

215x215x78mm

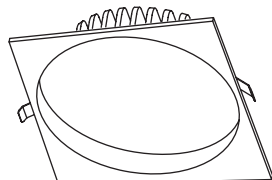

283x283x83mm

○ 7W · \varnothing 86mm · 350mA

K50315.W.3K	560 lm	3000K
K50315.W.4K	581 lm	4000K

○ 12W · \varnothing 136mm · 350mA

K50316.W.3K	960 lm	3000K
K50316.W.4K	996 lm	4000K

○ 25W · \varnothing 201mm · 700mA

K50317.W.3K	2000 lm	3000K
K50317.W.4K	2075 lm	4000K

○ 35W · \varnothing 266mm · 700mA

K50318.W.3K	2800 lm	3000K
K50318.W.4K	2905 lm	4000K

TINA ROUND

REF. K50405 - K50406



IP/20

CRI ≥80



INC.

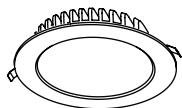

Ø108x45mm

○ **8W** · \varnothing Ø98mm · 300mA

K50405.W.3K 358 lm 3000K

K50405.W.4K 459 lm 4000K

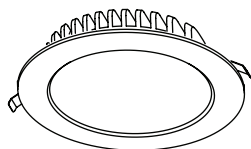

Ø172x50mm

○ **20W** · \varnothing Ø162mm · 300mA

K50406.W.3K 920 lm 3000K

K50406.W.4K 1200 lm 4000K

LED PERIMETRAL



PERIMETRAL LED

TINA SQUARE

REF. K50415 - K50416



IP 20

CRI ≥80



INC.

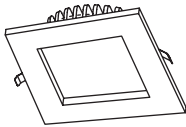

108x108x45mm

○ **8W** · 98x98mm · 300mA

K50415.W.3K	358 lm	3000K
K50415.W.4K	459 lm	4000K

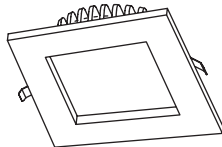

180x180x45mm

○ **20W** · 165x165mm · 300mA

K50416.W.3K	920 lm	3000K
K50416.W.4K	1200 lm	4000K

CIRQUE

REF. K50400 - K50401

IP
20CRI
≥80

INC.

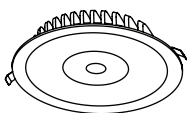

Ø120x40mm

○ **8+5W** · Ø105mm · 300mA

K50400.W.3K	788 lm	3000K
K50400.W.4K	803 lm	4000K

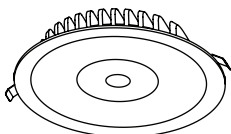

Ø177x40mm

○ **15+7W** · Ø165mm · 300mA

K50401.W.3K	1651 lm	3000K
K50401.W.4K	1903 lm	4000K

LED PERIMETRAL



PERIMETRAL LED

CORNER

REF. K50410 - K50411



IP/20 CRI ≥80



INC.

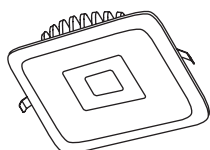

120x120x40mm

○ **8+5W** · □ 105x105mm · 300mA

K50410.W.3K	813 lm	3000K
K50410.W.4K	838 lm	4000K

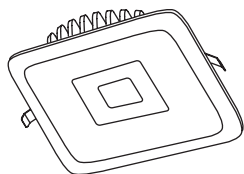

180x180x40mm

○ **15+7W** · □ 165x165mm · 300mA

K50411.W.3K	1771 lm	3000K
K50411.W.4K	1752 lm	4000K

TINY ROUND

REF. K50600

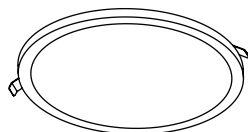

Ø88x22mm

○ 8W · ϕ Ø75 mm · 240mA

K50600.W.4K

720 lm

4000K

TINY SQUARE

REF. K50601

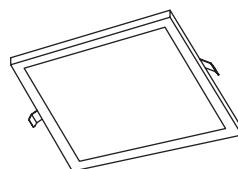

88x88x22mm

○ 8W · ϕ Ø75 mm · 240mA

K50601.W.4K

720 lm

4000K



LED INTEGRADO - INTEGRATED LED

REBECCA

REF. K53270

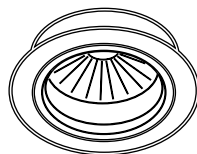

90 mm

Ø 93 mm

○ 3000K 10W · Ø80mm · 320mA

K53270.W.D40.3K	40°	990 lm	NO DIM
K53270.W.D40.3K.PC	40°	990 lm	PC
K53270.W.D60.3K	60°	990 lm	NO DIM
K53270.W.D60.3K.PC	60°	990 lm	PC

● 3000K 10W · Ø80mm · 320mA

K53270.SA.D40.3K	40°	990 lm	NO DIM
K53270.SA.D40.3K.PC	40°	990 lm	PC
K53270.SA.D60.3K	60°	990 lm	NO DIM
K53270.SA.D60.3K.PC	60°	990 lm	PC

○ 4000K 10W · Ø80mm · 320mA

K53270.W.D40.4K	40°	1010 lm	NO DIM
K53270.W.D40.4K.PC	40°	1010 lm	PC
K53270.W.D60.4K	60°	1010 lm	NO DIM
K53270.W.D60.4K.PC	60°	1010 lm	PC

● 4000K 10W · Ø80mm · 320mA

K53270.SA.D40.4K	40°	1010 lm	NO DIM
K53270.SA.D40.4K.PC	40°	1010 lm	PC
K53270.SA.D60.4K	60°	1010 lm	NO DIM
K53270.SA.D60.4K.PC	60°	1010 lm	PC

REBECCA SQUARE

REF. K53271



IP/20

30°

350°

CRI ≥80



INC.

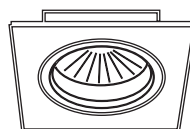

90 mm

93x93 mm

3000K 10W · Ø80mm · 320mA

K53271.W.D40.3K 40° 990 lm NO DIM

K53271.W.D40.3K.PC 40° 990 lm PC

K53271.W.D60.3K 60° 990 lm NO DIM

K53271.W.D60.3K.PC 60° 990 lm PC

3000K 10W · Ø80mm · 320mA

K53271.SA.D40.3K 40° 990 lm NO DIM

K53271.SA.D40.3K.PC 40° 990 lm PC

K53271.SA.D60.3K 60° 990 lm NO DIM

K53271.SA.D60.3K.PC 60° 990 lm PC

4000K 10W · Ø80mm · 320mA

K53271.W.D40.4K 40° 1010 lm NO DIM

K53271.W.D40.4K.PC 40° 1010 lm PC

K53271.W.D60.4K 60° 1010 lm NO DIM

K53271.W.D60.4K.PC 60° 1010 lm PC

4000K 10W · Ø80mm · 320mA

K53271.SA.D40.4K 40° 1010 lm NO DIM

K53271.SA.D40.4K.PC 40° 1010 lm PC

K53271.SA.D60.4K 60° 1010 lm NO DIM

K53271.SA.D60.4K.PC 60° 1010 lm PC

LED INTEGRADO - INTEGRATED LED

DARA

REF. K50300 - K50303



K50300

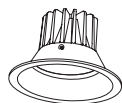

Ø100x85mm

K50301

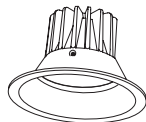

Ø160x110mm

K50302

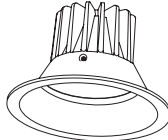

Ø190x110mm

K50303

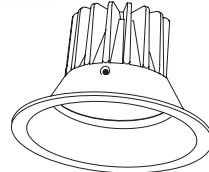

Ø230x110mm

○ **7W** · \varnothing Ø86mm · 350mA

K50300.W.3K	40°	790 lm	3000K
K50300.W.4K	40°	796 lm	4000K

○ **20W** · \varnothing Ø145mm · 540mA

K50301.W.3K	40°	1840 lm	3000K
K50301.W.4K	40°	2010 lm	4000K

○ **30W** · \varnothing Ø175mm · 750mA

K50302.W.3K	40°	2764 lm	3000K
K50302.W.4K	40°	2836 lm	4000K

○ **40W** · \varnothing Ø215mm · 750mA

K50303.W.3K	40°	3200 lm	3000K
K50303.W.4K	40°	3320 lm	4000K

REFLECTOR	REF.
15° /24° /60°	KAC50300.D15 - KAC50300.D24 - KAC50300.D60
15° /24° /60°	KAC50301.D15 - KAC50301.D24 - KAC50301.D60
24° /60°	KAC50302.D24 - KAC50302.D60
60°	KAC50303.D60

LASSO

REF. K50700 - K50701

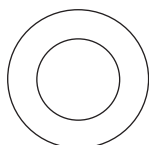

Ø50x40mm



○ 3W · \varnothing Ø35mm

K50700.W Chip COB 3000K



○ 3W · \varnothing Ø35mm

K50701.W Chip COB 3000K



TUBO PVC - PVC TUBE

Opcional para paredes especiales
For special walls

KAC50700 \varnothing Ø40mm

DETEK

REF. K53265- K53267



○ **16W · 60mA · 350x105 mm**

K53265.3K	DETECTOR DE PRESENCIA - PRESENCE DETECTOR	1040 lm	3000K
K53265.4K	DETECTOR DE PRESENCIA - PRESENCE DETECTOR	1140 lm	4000K
K53266.3K	-	1040 lm	3000K
K53266.4K	-	1140 lm	4000K



○ **12W · 60mA · 280x105 mm**

K53267.3K	DETECTOR DE PRESENCIA - PRESENCE DETECTOR	750 lm	3000K
K53267.4K	DETECTOR DE PRESENCIA - PRESENCE DETECTOR	800 lm	4000K

SENSOR MICROONDAS
MICROWAVES SENSOR

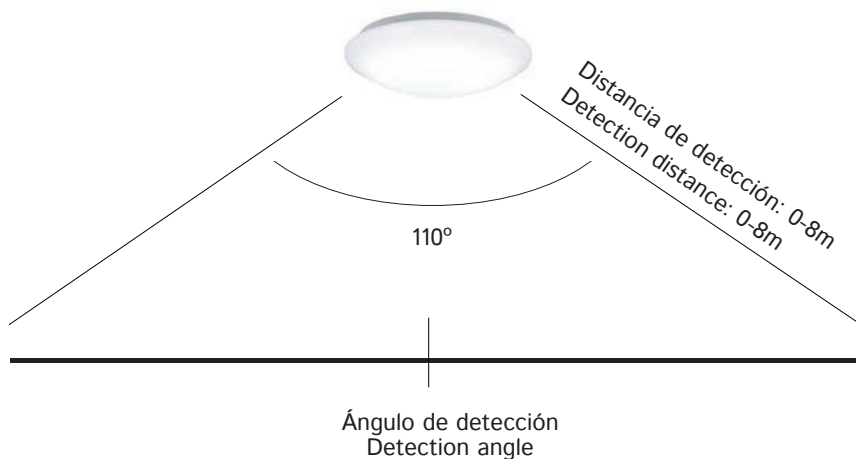

SUN
REF. K50140

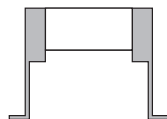
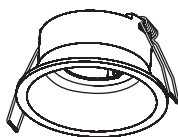

Ø75x45mm

MAX.50W · ϕ Ø65mm

K50140.W.GU	GU10	BLANCO - WHITE
K50140.BK.GU	GU10	NEGRO - BLACK

DAWN
REF. K50141

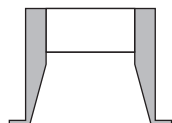
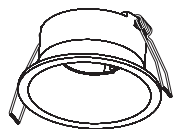

Ø75x45mm

MAX.50W · ϕ Ø65mm

K50141.W.GU	GU10	BLANCO - WHITE
K50141.BK.GU	GU10	NEGRO - BLACK

MOON

REF. K50110

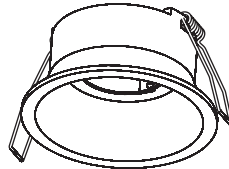

Ø85x45mm

MAX.50W · Ø75mm

K50110.W.GU	GU10	BLANCO - WHITE
K50110.BK.GU	GU10	NEGRO - BLACK

VENUS

REF. K50111

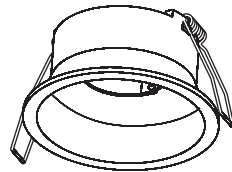

Ø92x40mm

MAX.50W · Ø80mm

K50111.W.GU	GU10	BLANCO - WHITE
K50111.BK.GU	GU10	NEGRO - BLACK

OZONE
REF. K50112

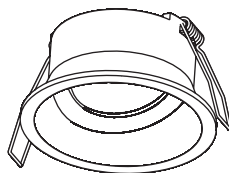

Ø90x57mm

MAX.50W · Ø82mm

K50112.W.GU	GU10	BLANCO - WHITE
K50112.BK.GU	GU10	NEGRO - BLACK

DIP IP65
REF. K50113

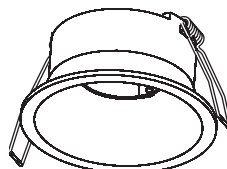
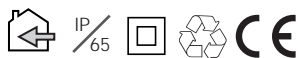

Ø86x44mm

MAX.50W · Ø73mm

K50113.W.GU	GU10	BLANCO - WHITE
K50113.BK.GU	GU10	NEGRO - BLACK

DAISY

REF. K50132

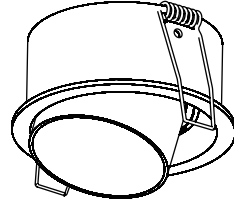

Ø83x37mm

MAX. 50W · ϕ Ø75mm

K50132.W.GU	GU10	BLANCO - WHITE
K50132.BK.GU	GU10	NEGRO - BLACK



DOT

REF. K50130



MAX.50W · \varnothing 70mm

K50130.W.GU	GU10	BLANCO - WHITE
K50130.BK.GU	GU10	NEGRO - BLACK

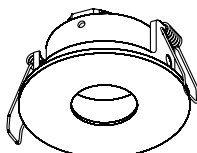

Ø80x33mm

DASH

REF. K50131

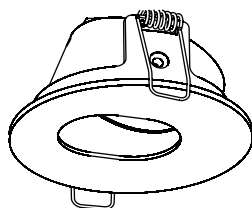
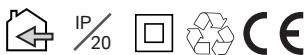

Ø80x33mm

MAX.50W · \varnothing 70mm

K50131.W.GU	GU10	BLANCO - WHITE
K50131.BK.GU	GU10	NEGRO - BLACK

FOCUS

REF. K50100



MAX.50W ·  123x78mm

K50100.W.GU	GU10	BLANCO - WHITE
K50100.BK.GU	GU10	NEGRO - BLACK

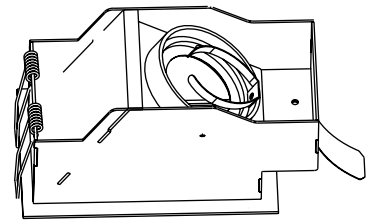

130x85mm



SAT ROUND

REF. K50126

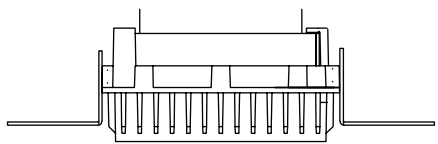

MAX.50W · \varnothing 96mm

K50126.W.GU	GU10	BLANCO - WHITE
K50126.BK.GU	GU10	NEGRO - BLACK

Ø81x62mm

SAT SQUARE

REF. K50125

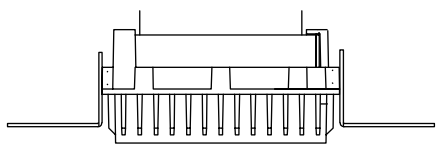
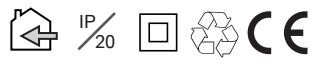

MAX.50W · 85x85mm

K50125.W.GU	GU10	BLANCO - WHITE
K50125.BK.GU	GU10	NEGRO - BLACK

73x73x52mm

BOLETUS

REF. K52400-K52401



IP

65



● **6,3W · 500mA**

K52400.BK 6,3W Ø110x112 mm 3000K 85 lm

K52401.BK 6,3W Ø110x160 mm 3000K 85 lm

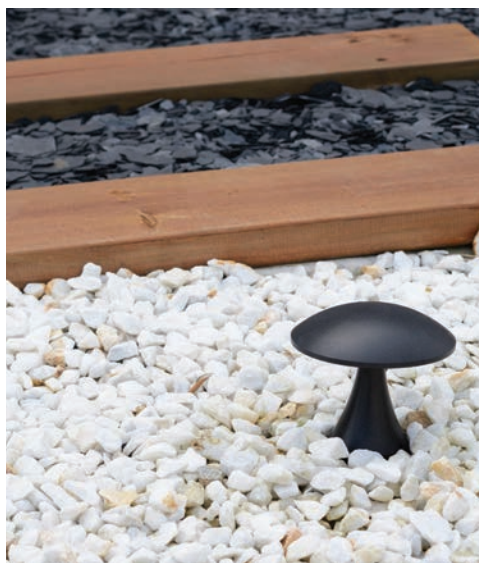
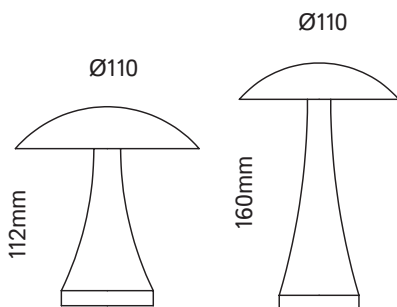



TOWER

REF. K52500 - K52502

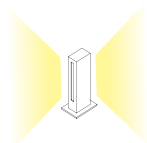
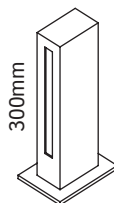
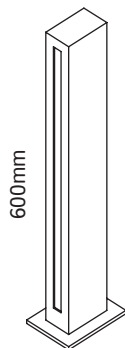
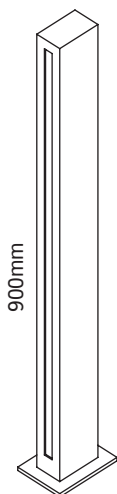

K52500.GY	16,7W	300 mm	356 lm	24V	3000K
K52501.GY	39W	600 mm	806 lm	24V	3000K
K52502.GY	57W	900 mm	1068 lm	24V	3000K





MAILBOX

REF. K52100

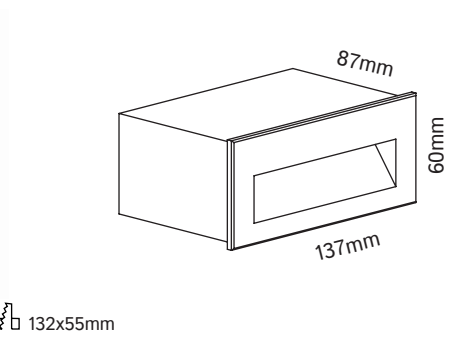

132x55mm

K52100.BK	3,8W	137x60 mm	3000K	107 lm	700 mA
K52100.GY	3,8W	137x60 mm	3000K	107 lm	700 mA

HUNTER

REF. K52200

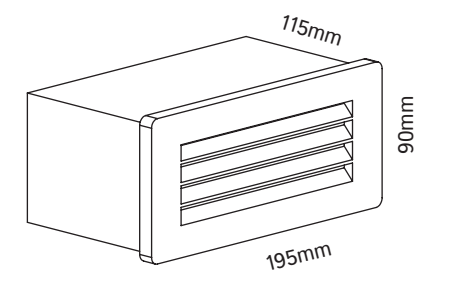

190x85mm

K52200.BK	7,6W	195x90 mm	3000K	114 lm	350 mA
-----------	------	-----------	-------	--------	--------

HAMMER ROUND

REF. K52300

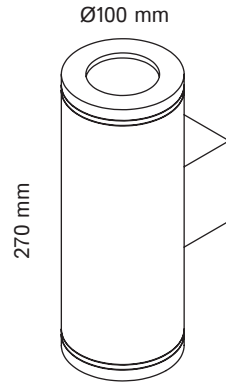

K52300.BK	30,6W	270 mm	3000K	1190 lm	700 mA
K52300.GY	30,6W	270 mm	3000K	1190 lm	700 mA

HAMMER SQUARE

REF. K52301

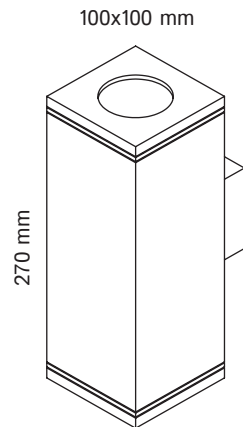

K52301.BK	30,6W	270 mm	3000K	1160 lm	700 mA
K52301.GY	30,6W	270 mm	3000K	1160 lm	700 mA

STORM

REF. K52600 - 52605



K52600.BK.27K	10W	Chip COB	NEGRO - BLACK	130x110x41	2700K	720 lm
K52600.BK.5K	10W	Chip COB	NEGRO - BLACK	130x110x41	5000K	850 lm
K52600.W.27K	10W	Chip COB	BLANCO - WHITE	130x110x41	2700K	720 lm
K52600.W.5K	10W	Chip COB	BLANCO - WHITE	130x110x41	5000K	850 lm
K52601.BK.27K	20W	Chip COB	NEGRO - BLACK	175x155x55	2700K	1400 lm
K52601.BK.5K	20W	Chip COB	NEGRO - BLACK	175x155x55	5000K	1700 lm
K52601.W.27K	20W	Chip COB	BLANCO - WHITE	175x155x55	2700K	1400 lm
K52601.W.5K	20W	Chip COB	BLANCO - WHITE	175x155x55	5000K	1700 lm
K52602.BK.27K	30W	Chip COB	NEGRO - BLACK	242x200x62	2700K	2000 lm
K52602.BK.5K	30W	Chip COB	NEGRO - BLACK	242x200x62	5000K	2460 lm
K52602.W.27K	30W	Chip COB	BLANCO - WHITE	242x200x62	2700K	2000 lm
K52602.W.5K	30W	Chip COB	BLANCO - WHITE	242x200x62	5000K	2460 lm

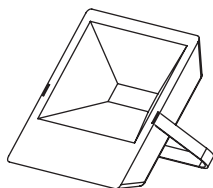

163x132x53 mm

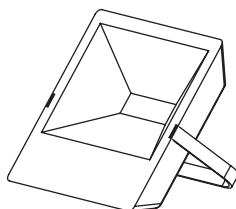

212x187x59 mm

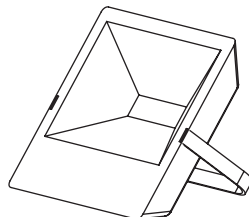

241x197x57 mm



K52603.BK.27K	50W	Chip COB	NEGRO - BLACK	242x200x62	2700K	3300 lm
K52603.BK.5K	50W	Chip COB	NEGRO - BLACK	242x200x62	5000K	4100 lm
K52603.W.27K	50W	Chip COB	BLANCO - WHITE	242x200x62	2700K	3300 lm
K52603.W.5K	50W	Chip COB	BLANCO - WHITE	242x200x62	5000K	4100 lm
K52604.BK.27K	100W	Chip COB	NEGRO - BLACK	280x250x77	2700K	6600 lm
K52604.BK.5K	100W	Chip COB	NEGRO - BLACK	280x250x77	5000K	8200 lm
K52604.W.27K	100W	Chip COB	BLANCO - WHITE	280x250x77	2700K	6600 lm
K52604.W.5K	100W	Chip COB	BLANCO - WHITE	280x250x77	5000K	8200 lm
K52605.BK.27K	150W	Chip COB	NEGRO - BLACK	345x313x83	2700K	9900 lm
K52605.BK.5K	150W	Chip COB	NEGRO - BLACK	345x313x83	5000K	12150 lm
K52605.W.27K	150W	Chip COB	BLANCO - WHITE	345x313x83	2700K	9900 lm
K52605.W.5K	150W	Chip COB	BLANCO - WHITE	345x313x83	5000K	12150 lm

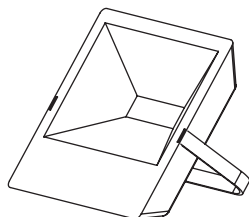

285x227x65 mm

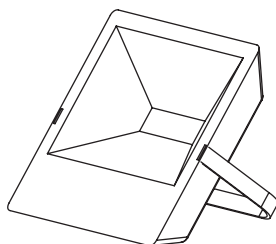

326x285x81 mm

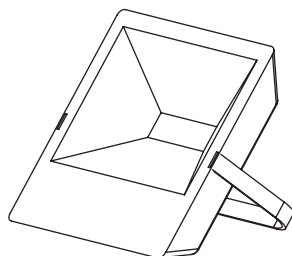

400x347x87 mm

TIRAS LED - LED STRIP



LUMIFLEX CC 14

5m - CRI≥80

60 LEDs/m

REF	Tensión Voltage	Tª. Color	LEDs/m	W/m	lm/m	IP	LED type	EE	Ancho/ Wide (mm)	mm
K55000.CC.27K.20	24V	2700K	60	14,4	1224	IP 20	2835	A+	10	100
K55000.CC.27K.65	24V	2700K	60	14,4	1224	IP 65	2835	A+	10	100
* K55000.CC.3K.20	24V	3000K	60	14,4	1296	IP 20	2835	A+	10	100
K55000.CC.3K.65	24V	3000K	60	14,4	1296	IP 65	2835	A+	10	100
* K55000.CC.4K.20	24V	4000K	60	14,4	1368	IP 20	2835	A+	10	100
K55000.CC.4K.65	24V	4000K	60	14,4	1368	IP 65	2835	A+	10	100
K55000.CC.55K.20	24V	5500K	60	14,4	1368	IP 20	2835	A+	10	100
K55000.CC.55K.65	24V	5500K	60	14,4	1368	IP 65	2835	A+	10	100

* CORTE A MEDIDA(max 50m) - CUSTOM CUT 4,00 €

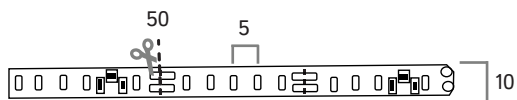

LUMIFLEX CC 28

5m - CRI≥80

120 LEDs/m

REF	Tensión Voltage	Tª. Color	LEDs/m	W/m	lm/m	IP	LED type	EE	Ancho/ Wide (mm)	mm
K55001.CC.27K.20	24V	2700K	120	28,8	2448	IP 20	2835	A+	10	50
K55001.CC.3K.20	24V	3000K	120	28,8	2592	IP 20	2835	A+	10	50
K55001.CC.4K.20	24V	4000K	120	28,8	2736	IP 20	2835	A+	10	50
K55001.CC.55K.20	24V	5500K	120	28,8	2736	IP 20	2835	A+	10	50

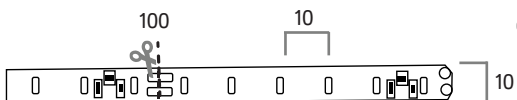

CRI≥90



FLEX PRO CC 20 CRI≥90

5m - CRI≥90

60 LEDs/m

REF	Tensión Voltage	Tª. Color	LEDs/m	W/m	lm/m	IP	LED type	EE	Ancho/ Wide (mm)	mm
K55002.CC.27K.20	24V	2700K	60	20	1400	IP 20	5630	A	10	100
K55002.CC.3K.20	24V	3000K	60	20	1500	IP 20	5630	A	10	100
K55002.CC.4K.20	24V	4000K	60	20	1560	IP 20	5630	A	10	100
K55002.CC.55K.20	24V	5500K	60	20	1600	IP 20	5630	A	10	100

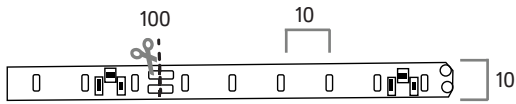

60 LEDs/m	FLEX CV ECO										5m - CRI≥80	
	REF	Tensión Voltage	Tª. Color	LEDs/m	W/m	lm/m	IP	LED type	EE	Ancho/ Wide (mm)	mm	
	K55003.CV.27K.20	24V	2700K	60	7,2	561,6	IP 20	3014	A+	10	100	
	K55003.CV.3K.20	24V	3000K	60	7,2	612	IP 20	3014	A+	10	100	
	K55003.CV.4K.20	24V	4000K	60	7,2	648	IP 20	3014	A+	10	100	
	K55003.CV.55K.20	24V	5500K	60	7,2	648	IP 20	3014	A+	10	100	

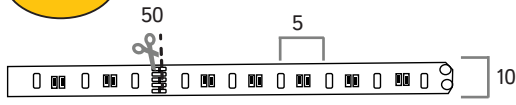

120 LEDs/m	FLEX CV 15										5m - CRI≥80	
	REF	Tensión Voltage	Tª. Color	LEDs/m	W/m	lm/m	IP	LED type	EE	Ancho/ Wide (mm)	mm	
	* K55008.CV.27K.20	24V	2700K	120	15	1100	IP 20	3014	A+	10	50	
	* K55008.CV.3K.20	24V	3000K	120	15	1200	IP 20	3014	A+	10	50	
	* K55008.CV.4K.20	24V	4000K	120	15	1400	IP 20	3014	A+	10	50	
	* K55008.CV.55K.20	24V	5500K	120	15	1500	IP 20	3014	A+	10	50	

* CORTE A MEDIDA(max 50m) - CUSTOM CUT 4,00 €

2700K - 6500K

CAMBIO DE Tª DE COLOR
DYNAMIC WHITE

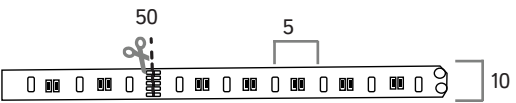

120 LEDs/m	FLEX CC BLANCO DINÁMICO										5m - CRI≥80	
	REF	Tensión Voltage	Tª. Color	LEDs/m	W/m	lm/m	IP	LED type	EE	Ancho/ Wide (mm)	mm	
	K55004.CC.TW.20	24V	2700K-6500K	120	19,2	561,6	IP 20	3527	A+	10	50	

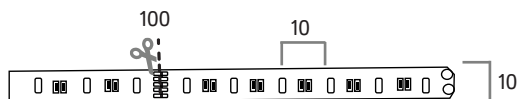

60 LEDs/m

SHOWFLEX CV RGBW

5m - CRI≥80

REF	Tensión Voltage	Tª. Color	LEDs/m	W/m	lm/m	IP	LED type	EE	Ancho/ Wide (mm)	mm
K55007.CV.RGBW.20	24V	3000K RGB	60	18	600	IP 20	5050	A	10	100

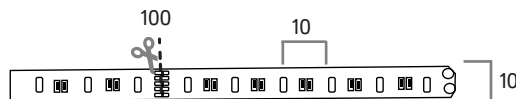

60 LEDs/m

SHOWFLEX CC RGB 14

5m - CRI≥65

REF	Tensión Voltage	Tª. Color	LEDs/m	W/m	lm/m	IP	LED type	EE	Ancho/ Wide (mm)	mm
K55005.CC.RGB.20	24V	RGB	60	14,4	600	IP 20	5050	B	10	100
K55005.CC.RGB.65	24V	RGB	60	14,4	600	IP 65	5050	B	10	100

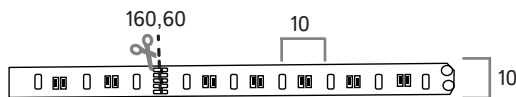

60 LEDs/m

SHOWFLEX CV RGB ECO

5m - CRI≥65

REF	Tensión Voltage	Tª. Color	LEDs/m	W/m	lm/m	IP	LED type	EE	Ancho/ Wide (mm)	mm
K55006.CV.RGB.20	24V	RGB	30	7,2	216	IP 20	5050	A	10	160,60

PERFILES - PROFILES



	REF	m
	KP50001.01	2m
	KP50001.02	3m
	KP50002.01	2m
	KP50002.02	3m
	KP50003.01	2m
	KP50003.02	3m

TÉCNICA TECHNICAL

LÁMPARAS - LAMPS

KB



CRI ≥80



Ø50x55mm

3000K

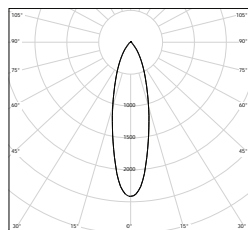

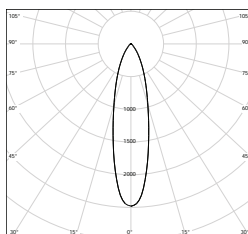

4000K



○ ● 7W - 40°

KB3K.W	GU10	570 lm	3000K
KB4K.W	GU10	623 lm	4000K
KB3K.BK	GU10	570 lm	3000K
KB4K.BK	GU10	623 lm	4000K

EQUIPOS - DRIVERS

	KD55100.20	ELT	TIRAS LED LED STRIP	20W	148x45,8x22,5 mm	IP20	24V
	KD55100.30	ELT	TIRAS LED LED STRIP	30W	148x45,8x22,5 mm	IP20	24V
	KD55100.50	ELT	TIRAS LED LED STRIP	50W	148x45,8x22,5 mm	IP20	24V
	KD55100.75	ELT	TIRAS LED LED STRIP	75W	157.5x636x30 mm	IP20	24V
	KD55101.100	TRIDONIC	TIRAS LED LED STRIP	100W	300x44x23 mm	IP20	24V
	KD55101.180	TRIDONIC	TIRAS LED LED STRIP	180W	280x64x31 mm	IP20	24V

REGULADORES - DIMMERS

	<p>REGULADOR TIRA DE LED - DIMMER LED STRIP KDFLEX1 6A/2CH TOUCH LED 4 ZONE 2.4G 144W (12V) 288W (24V) 152x41x28 mm</p>
-----------------------------------------------------------------------------------	------------------------------------------------------------------------------------------------------------------------------------------------------------------------------------------------------------------------------------------------

ACCESORIOS - ACCESSORIES FLEX BLANCO DINÁMICO

	<p>CONTROLADOR TEMPERATURA DE COLOR CONTROLLER COLOR TEMPERATURE</p> <p>KACFLEX1 4 ZONE 2.4G 4A/2CH 96W (12V) 192W (24V) 85x45x23 mm</p>
	<p>CONTROLADOR TEMPERATURA DE COLOR CONTROLLER COLOR TEMPERATURE</p> <p>KACFLEX2 4 ZONE 2.4G 6A/4CH 144W (12V) 288W (24V) 152x41x28 mm</p>

ACCESORIOS - ACCESSORIES RGB

 <p>RGB AMPLIFIER Input/Output Voltage DC12-24V Total Output of Current 12A</p>	<p>AMPLIFICADOR RGB - <i>RGB AMPLIFIER</i> KACRGB1 DC12V-24V 3 CH 4A/CH 144W (12V) 288W (24V) 105x64x23 mm</p>
	<p>CONTROLADOR RGB - <i>RGB CONTROLLER</i> KACRGB2 DC12V-24V 3 CH 4A/CH 144W (12V) 288W (24V) 85x45x23 mm</p>
 <p>TOUCH LED CONTROLLER</p>	<p>CONTROLADOR RGB - <i>RGB CONTROLLER</i> KACRGB3 DC12V-24V 3 CH 6A/CH 144W (12V) 288W (24V) 83x79x32 mm</p>
	<p>CONTROLADOR RGB PARED - <i>RGB WALL CONTROLLER</i> KACRGB4 DC12V-24V 3 CH 4A/CH 144W (12V) 288W (24V) 86x86x32 mm</p>
 <p>DMX512 LED Controller Input/Output Voltage DC12-24V Total Output of Current 12A</p>	<p>DECODIFICADOR DMX - <i>DMX LED CONTROLLER</i> KACRGB5 DC12V-24V 3 CH 4A/CH 144W (12V) 288W (24V) 177x40x32 mm</p>

ACCESORIOS - ACCESSORIES SHOWFLEX RGBW

	<p>CONTROLADOR RGBW - <i>RGBW CONTROLLER</i> KACRGBW1 DC12V-24V 6A/4CH 288W (12V) 576W (24V) 153x41x29 mm</p>
-------------------------------------------------------------------------------------	------------------------------------------------------------------------------------------------------------------------------------------

FOTOMETRÍAS - PHOTOMETRICS

MODELO: WINNER - ELITE - CHESS
REF: K50503 - K50504 - K50505 - K50506 - K50500 - K50501
 3000K - 4000K - 6000K
 OPAL

OPAL

3000K

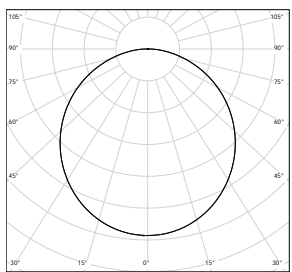

4000K

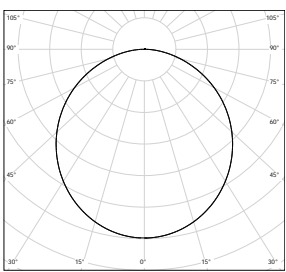

6000K

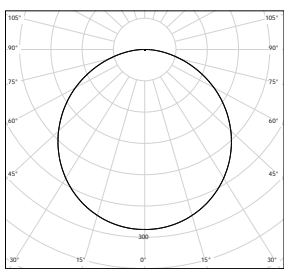

MODELO: WINNER - ELITE - CHESS
REF: K50503 - K50504 - K50505 - K50506 - K50500 - K50501
 3000K - 4000K - 6000K
 MICROPRISMATIC

MICROPRISMÁTICO - MICROPRISMATIC

3000K

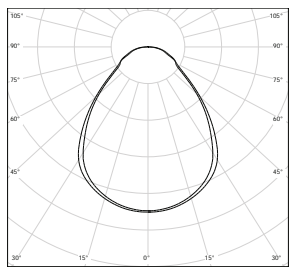

4000K

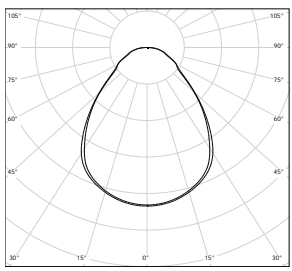

6000K

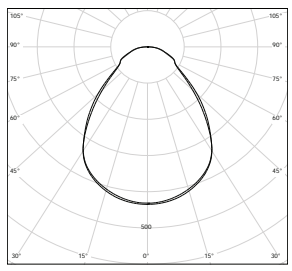

MODELO: DISC - DISC SURFACE

REF: K50200 - K50201 - K50202 -
K50203 - K50206 - K50220 - K50221
K50222 - K50223 - K50225 - K50226

3000K - 4000K - 6000K

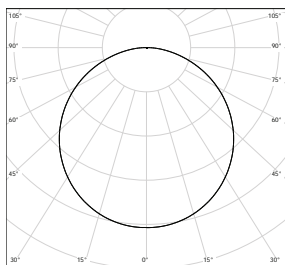

**MODELO: DISC SQUARE
DISC SQUARE SURFACE**

REF: K50210 - K50211 - K50212 -
K50230 - K50231 - K50232 - K50233

3000K - 4000K - 6000K

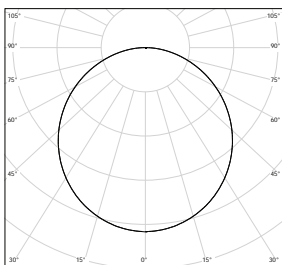

**MODELO: MARJAL - MARJAL
SQUARE**

REF: K53262 - K553261 - K53260 -
K53252 - K53251 - K53250

3000K - 4000K

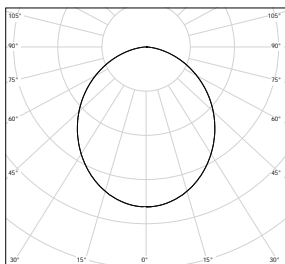

MODELO: LIM ROUND - LIM SQUARE

REF: K50310 - K50311 - K50312
- K50313 - K50315 - K50316 - K50317-
K50318

3000K - 4000K

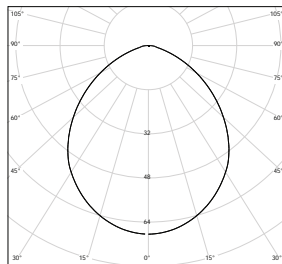

**MODELO: TINA ROUND - TINA
SQUARE**

REF: K50405 - K50406 - K50415 -
K50416

3000K - 4000K

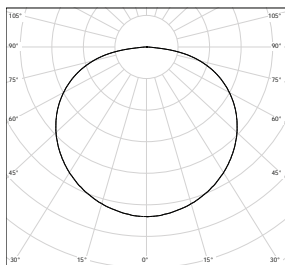

**MODELO: REBECCA - REBECCA
SQUARE**

REF: K53270 - K53271

3000K - 4000K

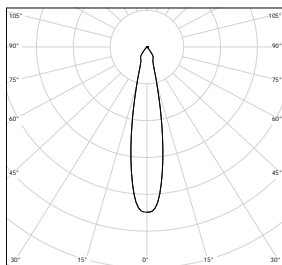

MODELO: CIRQUE

REF: K50400 - K50401

3000K - 4000K

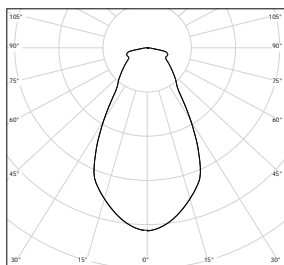

MODELO: CORNER

REF: K50410 - K50411

3000K - 4000K

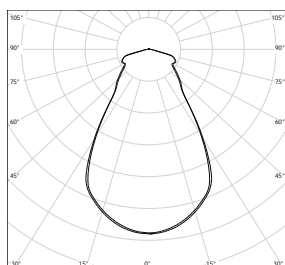

MODELO: DARA

REF: K50300 - K50301 - K50302 - K50303

3000K - 4000K

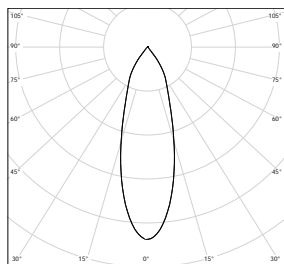

MODELO: CLASSIC LED

REF: K54275 - K54276

3000K - 4000K

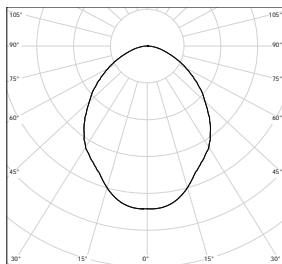

MODELO: DETEK

REF: K53265 - K53266

3000K - 4000K

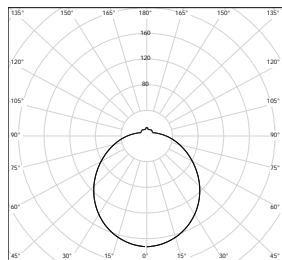

MEDIDA DE CORTE - CUT OUT

K50140	SUN	Ø65mm
K50141	DAWN	Ø65mm
K50130	DOT	Ø70mm
K50131	DASH	Ø70mm
K50113	DIP	Ø73mm
K50110	MOON	Ø75mm
K50132	DAISY	Ø75mm
K50600	TINY ROUND	Ø75mm
K50601	TINY SQUARE	Ø75mm
K50111	VENUS	Ø80mm
K53270	REBECCA	Ø80mm
K53271	REBECCA SQUARE	Ø80mm
K50112	OZONE	Ø82mm
K50125	SAT SQUARE	85x85mm
K50300	DARA	Ø86mm
K50310	LIM ROUND	Ø86mm
K50315	LIM SQUARE	Ø86mm
K53262	MARJAL	Ø90mm
K53252	MARJAL SQUARE	Ø90mm
K50126	SAT ROUND	Ø96mm
K50405	TINA ROUND	Ø98mm
K50415	TINA SQUARE	98x98mm
K50400	CIRQUE	Ø105mm
K50210	DISC SQUARE	105x105mm
K50410	CORNER	105x105mm
K50200	DISC	Ø108mm
K50100	FOCUS	123x78mm
K53261	MARJAL	Ø135mm
K53251	MARJAL SQUARE	Ø135mm
K50311	LIM ROUND	Ø136mm
K50316	LIM SQUARE	Ø136mm
K50301	DARA	Ø145mm
K50201	DISC	Ø155mm
K50211	DISC SQUARE	155x155mm
K50406	TINA ROUND	Ø162mm
K50401	CIRQUE	Ø165mm
K50411	CORNER	165x165mm
K50416	TINA SQUARE	165x165mm

K50302	DARA	Ø175mm
K50312	LIM ROUND	Ø201mm
K50317	LIM SQUARE	Ø201mm
K50202	DISC	Ø205mm
K50212	DISC SQUARE	205x205mm
K53260	MARJAL	Ø210mm
K53250	MARJAL SQUARE	Ø210mm
K50303	DARA	Ø215mm
K50318	LIM SQUARE	Ø266mm
K50313	LIM ROUND	Ø266mm
K50203	DISC	Ø280mm
K50206	DISC	Ø585mm

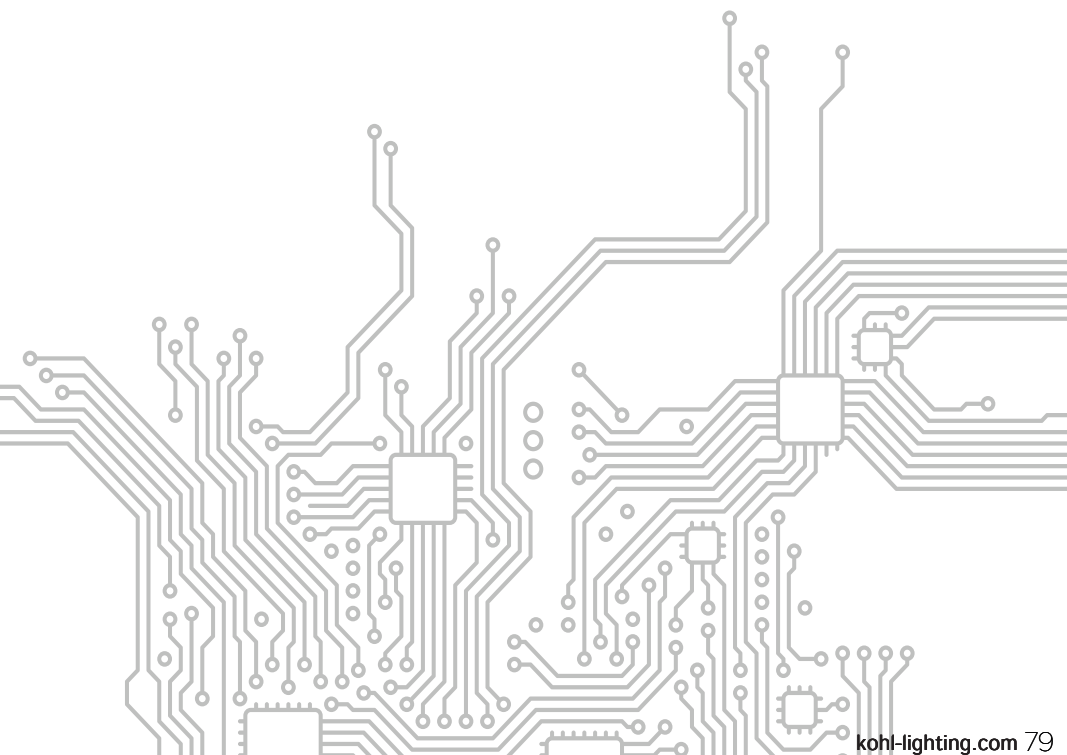



From this moment on the company Kohl Lighting reserves the right to total or partial reproduction of this catalog as the Copyright owner.

All models are protected by patents owned by the company. The R & D team of the company has the right to change or delete data and technical specifications of the models in this catalog for reasons related to the improvement and development of new products.

Kohl Lighting
Copyright © 2016

www.kohl-lighting.com