

2014

katalog produktů

GreenWorld with



GREENLUX®



GREENLUX®

Držíte v rukách katalog produktů společnosti **Greenlux** pro rok **2014**.

Jeho obsah Vám napoví mnohé o směřování a strategii společnosti pro následující rok. Věříme v technologii LED a snažíme se vyhledávat to nejlepší a nejnovější, co v dané oblasti existuje. Stále se přitom zaměřujeme na zachování co nejlepšího poměru mezi výkonem a cenou.

Chtěl bych Vás upozornit zejména na LED trubice. Naměřené hodnoty ve svítidlech potvrdily, že jsou minimálně stejně výkonné (světelný tok) jako zářivky T8. Žhavou novinkou jsou i plafonier y LED Scalea, které Vás, jak doufám, zaujmou jak svým výkonem, všestranností použití, ale i příznivou cenou.

Zprávy o ekonomickém vývoji v Evropě začínají být mnohem více pozitivní. Doufejme, že se to projeví velmi rychle i na oživení české a slovenské ekonomiky. Přejme si tedy do naší další spolupráce hodně úspěchů.



Za společnost Greenlux s.r.o.
Ing. **Pavel Kovář**, MBA
jednatel společnosti

LED ZDROJE

LED SVÍTIDLA

TECHNICKÁ SVÍTIDLA

PODHLÉDOVÁ BODOVÁ
SVÍTIDLA

SVĚTELNÉ ZDROJE

KANCELÁŘSKÁ SVÍTIDLA
A SVÍTIDLA PRO DOMÁCNOST

ELEKTROINSTALAČNÍ
MATERIÁL

LED ZDROJE



LED SVÍTIDLA

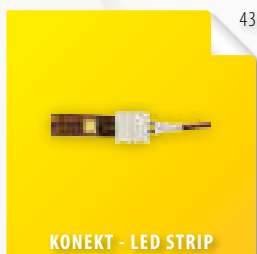
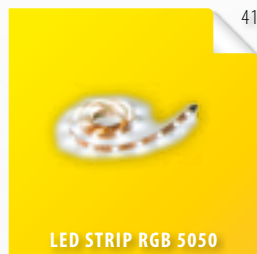
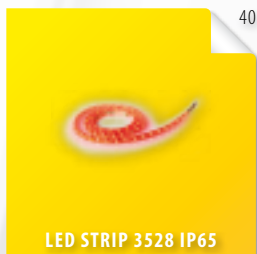
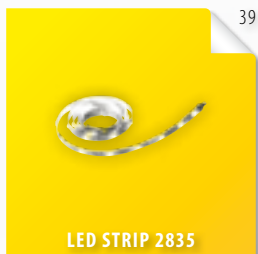
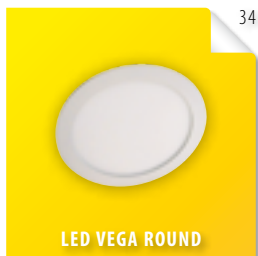
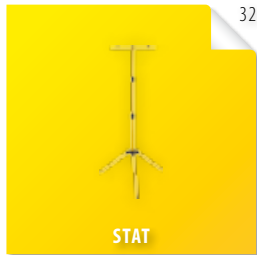
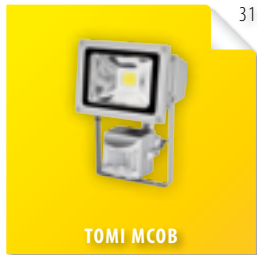

TECHNICKÁ SVÍTIDLA

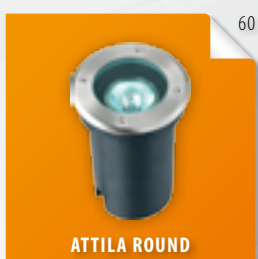
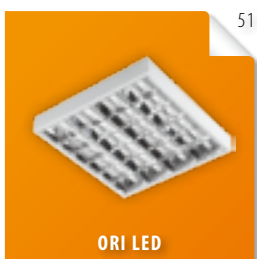

PODHLADOVÁ BODOVÁ SVÍTIDLA

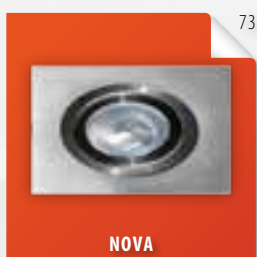
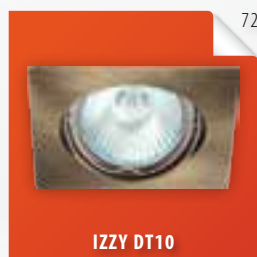
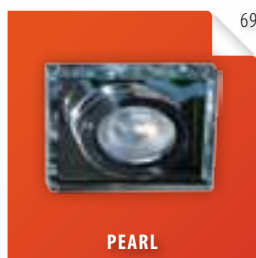
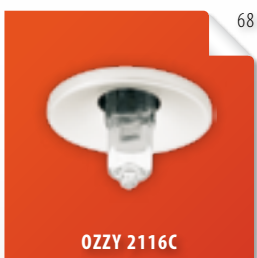
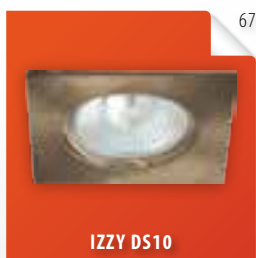

SVĚTELNÉ ZDROJE



KANCELÁŘSKÁ SVÍTIDLA A SVÍTIDLA PRO DOMÁCNOST

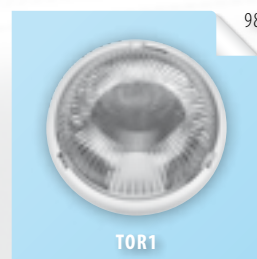
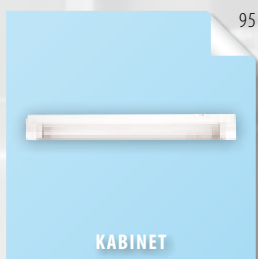
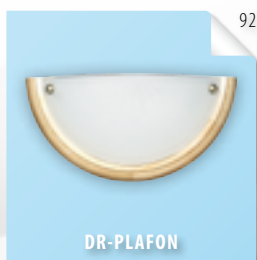

ELEKTROINSTALAČNÍ MATERIÁL



LED ZDROJE

LED30 SMD 2835 GU10 5W

NEW
NEW SMD 2835



Světelný zdroj LED SMD

- náhrada halogenových žárovek JDR/GU10
- vysoká účinnost - ekvivalent 45W
- o 90% nižší spotřeba energie
- nová technologie LED SMD (30 x LED SMD typu 2835)
- ochranné sklo
- životnost - 50 000 hodin

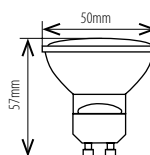

								DKC
LED30 SMD 2835 GU10 5W-CW	GXLZ131	8592660108032	<input type="checkbox"/> studená bílá	5	6000K	525	≥80	324,- Kč
LED30 SMD 2835 GU10 5W-WW	GXLZ132	8592660108049	<input type="checkbox"/> teplá bílá	5	2800K	510	≥80	324,- Kč

LED38 SMD 2835 GU10 4W

NEW
NEW SMD 2835

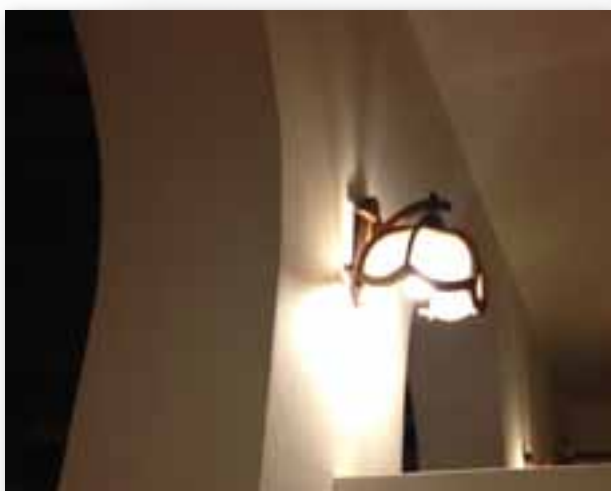

Světelný zdroj LED SMD

- náhrada halogenových žárovek JDR/GU10
- vysoká účinnost - ekvivalent 40W
- o 90% nižší spotřeba energie
- nová technologie LED SMD (38 x LED SMD typu 2835)
- ochranné sklo
- životnost - 50 000 hodin

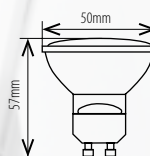

								DKC
LED38 SMD 2835 GU10 4W-CW	GXLZ110	8592660106373	<input type="checkbox"/> studená bílá	4	6000 K	420	≥80	209,- Kč
LED38 SMD 2835 GU10 4W-WW	GXLZ109	8592660106366	<input type="checkbox"/> teplá bílá	4	2800 K	400	≥80	209,- Kč

LED36 SMD 2835 MR16 4W

NEW
SMD
2835



Světelný zdroj LED SMD

- náhrada halogenových žárovek MR16
- vysoká účinnosť - ekvivalent 40W
- o 90% nižšia spotreba energie
- nová technológia LED SMD (36 x LED SMD typu 2835)
- ochranné sklo
- životnosť - 50 000 hodín

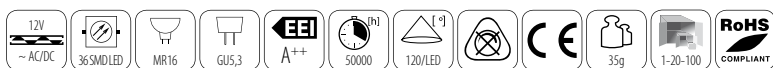
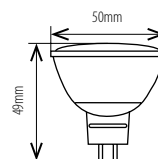

		 EAN						DKC
LED36 SMD 2835 MR16 4W-CW	GXLZ104	8592660106311	<input type="checkbox"/> studená biľá	4	6000 K	420	≥80	202,- Kč
LED36 SMD 2835 MR16 4W-WW	GXLZ103	8592660106304	<input type="checkbox"/> teplá biľá	4	2800 K	400	≥80	202,- Kč

LED38 SMD 2835 E14 4W

NEW
SMD
2835



Světelný zdroj LED SMD

- náhrada reflektorových žárovek E14 - R50
- vysoká účinnost - ekvivalent 60W
- o více než 90% nižší spotřeba energie
- nová technologie LED SMD (38 x LED SMD typu 2835)
- ochranné sklo
- životnost - 50 000 hodin

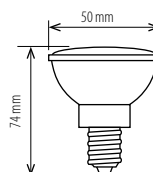

									DKC
LED38 SMD 2835 E14 4W-CW	GXLZ108	8592660106359	<input type="checkbox"/> studená bílá	4	6000 K	420	≥80	234,- Kč	
LED38 SMD 2835 E14 4W-WW	GXLZ107	8592660106342	<input type="checkbox"/> teplá bílá	4	2800 K	400	≥80	234,- Kč	

LED38 SMD 2835 E27 4W

NEW
SMD
2835



Světelný zdroj LED SMD

- náhrada reflektorových žárovek E27 - R50
- vysoká účinnost - ekvivalent 60W
- o více než 90% nižší spotřeba energie
- nová technologie LED SMD (38 x LED SMD typu 2835)
- ochranné sklo
- životnost - 50 000 hodin



									DKC
LED38 SMD 2835 E27 4W-CW	GXLZ106	8592660106335	<input type="checkbox"/> studená bílá	4	6000 K	420	≥80	236,- Kč	
LED38 SMD 2835 E27 4W-WW	GXLZ105	8592660106328	<input type="checkbox"/> teplá bílá	4	2800 K	400	≥80	236,- Kč	

LED30 SMD 2835 GU10 3W

NEW SMD 2835



Světelný zdroj LED SMD

- náhrada halogenových žárovek JDR/GU10
- vysoká účinnost - ekvivalent 35W
- o 90% nižší spotřeba energie
- nová technologie LED SMD (30 x LED SMD typu 2835)
- ochranné sklo
- životnost - 50 000 hodin

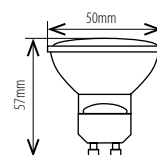

									DKC
LED30 SMD 2835 GU10 3W - CW	GXLZ101	8592660106281	<input type="checkbox"/> studená bílá	3	6000 K	320	≥80	193,- Kč	
LED30 SMD 2835 GU10 3W - WW	GXLZ102	8592660106298	<input type="checkbox"/> teplá bílá	3	2800 K	300	≥80	193,- Kč	

LED20 SMD 2835 GU10 2W

NEW SMD 2835



Světelný zdroj LED SMD

- náhrada halogenových žárovek JDR/GU10
- vysoká účinnost - ekvivalent 25W
- o 90% nižší spotřeba energie
- nová technologie LED SMD (20 x LED SMD typu 2835)
- ochranné sklo
- životnost - 50 000 hodin

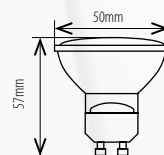

									DKC
LED20 SMD 2835 GU10 2W-CW	GXLZ120	8592660106472	<input type="checkbox"/> studená bílá	2	6000 K	220	≥80	159,- Kč	
LED20 SMD 2835 GU10 2W-WW	GXLZ119	8592660106465	<input type="checkbox"/> teplá bílá	2	2800 K	200	≥80	159,- Kč	

LED9 SMD 2835 GU10 2W

NEW
SMD
2835



Světelný zdroj LED SMD

- náhrada halogenových žárovek JDR/GU10
- vysoká účinnosť - ekvivalent 25W
- o 90% nižšia spotreba energie
- nová technológia LED SMD (9 x LED SMD typu 2835)
- ochranné sklo
- životnosť - 50 000 hodín

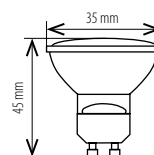

									DKC
LED9 SMD 2835 GU10 2W-CW	GXLZ124	8592660106625	<input type="checkbox"/> studená biľá	2	6000 K	210	≥80	149,- Kč	
LED9 SMD 2835 GU10 2W-WW	GXLZ123	8592660106618	<input type="checkbox"/> teplá biľá	2	2800 K	200	≥80	149,- Kč	

LED9 SMD 2835 MR11 2W

NEW
SMD
2835



Světelný zdroj LED SMD

- náhrada reflektorových žárovek MR11
- vysoká účinnosť - ekvivalent 25W
- o viac než 90% nižšia spotreba energie
- nová technológia LED SMD (9 x LED SMD typu 2835)
- ochranné sklo
- životnosť - 50 000 hodín

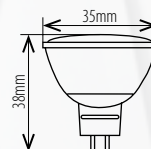

									DKC
LED9 SMD 2835 MR11 2W-CW	GXLZ121	8592660106595	<input type="checkbox"/> studená biľá	2	6000 K	210	≥80	149,- Kč	
LED9 SMD 2835 MR11 2W-WW	GXLZ122	8592660106601	<input type="checkbox"/> teplá biľá	2	2800 K	200	≥80	149,- Kč	

LED EYE 360° E27 6W



Úsporná žárovka SMD LED

- náhrada za klasické žárovky E27
- o 85% nižší spotřeba energie
- nová technologie LED SMD (66 LED SMD typu 2835)
- životnost 35 000 hodin

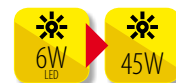
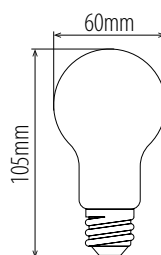

								DKC
LED EYE 360 6W CW	GXLZ137	8592660109114	<input type="checkbox"/> studená bílá	6	6000K	550	≥80	299,- Kč
LED EYE 360 6W WW	GXLZ138	8592660109107	<input type="checkbox"/> teplá bílá	6	2800K	530	≥80	299,- Kč

LED CANDLE E14 4W



Světelný zdroj SMD LED

- více než 85% nižší spotřeba energie ve srovnání s klasickými žárovkami
- více než 30% nižší spotřeba energie ve srovnání s kompaktními žárovkami třídy A
- nová technologie – vysoce výkonné LED SMD (21 diod LED typu SMD 2835)
- životnost: 50 000 hodin

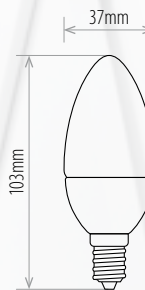

								DKC
LED CANDLE E14 4W CW	GXLZ062	8592660105642	<input type="checkbox"/> studená bílá	4	6400K	420	≥80	185,- Kč
LED CANDLE E14 4W WW	GXLZ063	8592660105659	<input type="checkbox"/> teplá bílá	4	3000K	390	≥80	185,- Kč

LED MINIGLOBE E14 4W

NEW
SMD
2835



Světelný zdroj SMD LED

- o více než 85% nižší spotřeba energie ve srovnání s klasickými žárovkami
- o více než 30% nižší spotřeba energie ve srovnání s kompaktními zářivkami třídy A
- nová technologie – vysoce výkonné diody LED SMD (21 diod LED typu SMD 2835)
- životnost: 50 000 hodin

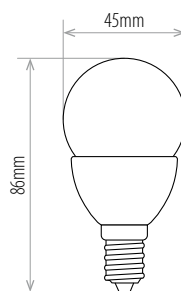

4W LED → 35W



									DKC
LED MINI GLOBE E14 4W - CW	GXLZ064	8592660105666	<input type="checkbox"/> studená bílá	4	6400K	420	≥80	185,- Kč	
LED MINI GLOBE E14 4W - WW	GXLZ065	8592660105673	<input type="checkbox"/> teplá bílá	4	3000K	390	≥80	185,- Kč	

LED MINIGLOBE E27 4W

NEW
SMD
2835



Světelný zdroj SMD LED

- o více než 85% nižší spotřeba energie ve srovnání s klasickými žárovkami
- o více než 30% nižší spotřeba energie ve srovnání s kompaktními zářivkami třídy A
- nová technologie – vysoce výkonné diody LED SMD (21 diod LED typu SMD 2835)
- životnost: 50 000 hodin

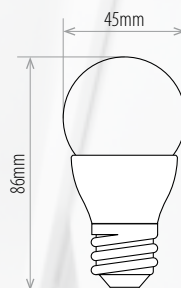

4W LED → 35W



									DKC
LED MINIGLOBE E27 4W CW	GXLZ153	8592660109312	<input type="checkbox"/> studená bílá	4	6400K	420	≥80	185,- Kč	
LED MINIGLOBE E27 4W WW	GXLZ154	8592660109305	<input type="checkbox"/> teplá bílá	4	3000K	390	≥80	185,- Kč	

LED13 SMD 2835 JC 2W

NEW NEW SMD 2835



Světelný zdroj LED SMD

- náhrada halogenových žárovek JC
- vysoká účinnost - ekvivalent 25W
- o 90% nižší spotřeba energie
- nová technologie LED SMD (13 x LED SMD typu 2835)
- životnost - 50 000 hodin

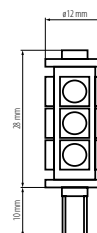

2W LED → 25W HALOGEN



									DKC
LED13 SMD 2835 JC 2W CW	GXLZ080	8592660108414	<input type="checkbox"/> studená bílá	2	6000K	245	≥80	189,- Kč	
LED13 SMD 2835 JC 2W WW	GXLZ081	8592660108421	<input type="checkbox"/> teplá bílá	2	2800K	235	≥80	189,- Kč	

LED18 SMD 2835

NEW NEW SMD 2835



Světelný zdroj LED SMD

- náhrada halogenových žárovek JC
- vysoká účinnost
- o 90% nižší spotřeba energie
- nová technologie LED SMD (18 x LED SMD typu 2835)
- životnost - 50 000 hodin

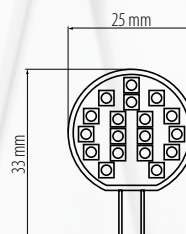

1W LED → 10W HALOGEN
2W LED → 20W HALOGEN



									DKC
LED18 SMD 2835 1W CW	GXLZ082	8592660108438	<input type="checkbox"/> studená bílá	1	6000K	130	≥80	129,- Kč	
LED18 SMD 2835 1W WW	GXLZ083	8592660108445	<input type="checkbox"/> teplá bílá	1	2800K	120	≥80	129,- Kč	
LED18 SMD 2835 2W CW	GXLZ084	8592660108490	<input type="checkbox"/> studená bílá	2	6000K	210	≥80	196,- Kč	
LED18 SMD 2835 2W WW	GXLZ085	8592660108506	<input type="checkbox"/> teplá bílá	2	2800K	200	≥80	196,- Kč	

LED23 SMD 2835 GU10 2,6W

NEW
NEW SMD 2835



Světelný zdroj SMD LED

- náhrada klasických a kompaktních žárovek
- o více než 90% nižší spotřeba energie ve srovnání s klasickými žárovkami
- o více než 45% nižší spotřeba energie ve srovnání s kompaktními zářivkami
- nové, vysoce výkonné diody LED SMD (23 diod LED typu SMD 2835)
- životnost: 50 000 hodin

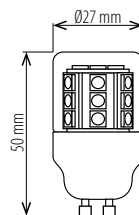

2,6W LED → 30W



									DKC
LED23 SMD 2835 GU10 2,6W-CW	GXLZ129	8592660106908	<input type="checkbox"/> studená bílá	2,6	6000K	315	≥80	218,- Kč	
LED23 SMD 2835 GU10 2,6W-WW	GXLZ130	8592660106915	<input type="checkbox"/> teplá bílá	2,6	2800K	305	≥80	218,- Kč	

LED23 SMD 2835 G9 2,6W

NEW
NEW SMD 2835



Světelný zdroj SMD LED

- náhrada klasických a kompaktních žárovek
- o více než 90% nižší spotřeba energie ve srovnání s klasickými žárovkami
- o více než 45% nižší spotřeba energie ve srovnání s kompaktními zářivkami
- nové, vysoce výkonné diody LED SMD (23 diod LED typu SMD 2835)
- životnost: 50 000 hodin

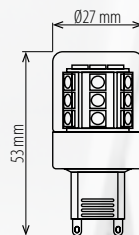

2,6W LED → 30W



									DKC
LED23 SMD 2835 G9 2,6W CW	GXLZ127	8592660106885	<input type="checkbox"/> studená bílá	2,6	6000K	315	≥80	218,- Kč	
LED23 SMD 2835 G9 2,6W WW	GXLZ128	8592660106892	<input type="checkbox"/> teplá bílá	2,6	2800K	305	≥80	218,- Kč	

LED23 SMD 2835 E27 2,6W



Světelný zdroj SMD LED

- náhrada klasických a kompaktních žárovek
- o více než 90% nižší spotřeba energie ve srovnání s klasickými žárovkami
- o více než 45% nižší spotřeba energie ve srovnání s kompaktními zářivkami
- nově, vysoce výkonné diody LED SMD (23 diod LED typu SMD 2835)
- životnost: 50 000 hodin

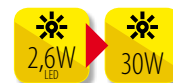
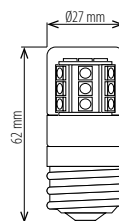

								DKC
LED23 SMD 2835 E27 2,6W-CW	GXLZ135	8592660108056	<input type="checkbox"/> studená bílá	2,6	6000K	315	≥80	218,- Kč
LED23 SMD 2835 E27 2,6W-WW	GXLZ136	8592660108063	<input type="checkbox"/> teplá bílá	2,6	2800K	305	≥80	218,- Kč

LED23 SMD 2835 E14 2,6W



Světelný zdroj SMD LED

- náhrada klasických a kompaktních žárovek
- o více než 90% nižší spotřeba energie ve srovnání s klasickými žárovkami
- o více než 45% nižší spotřeba energie ve srovnání s kompaktními zářivkami
- nově, vysoce výkonné diody LED SMD (23 diod LED typu SMD 2835)
- životnost: 50 000 hodin

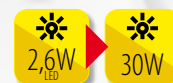
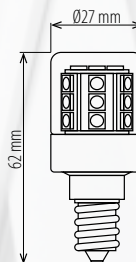

								DKC
LED23 SMD 2835 E14 2,6W-CW	GXLZ125	8592660106861	<input type="checkbox"/> studená bílá	2,6	6000K	315	≥80	218,- Kč
LED23 SMD 2835 E14 2,6W-WW	GXLZ126	8592660106878	<input type="checkbox"/> teplá bílá	2,6	2800K	305	≥80	218,- Kč

LED T8-840



Světelný zdroj LED T8

- energeticky úsporná náhrada lineárních zářivek T8
- vybaveno integrovaným driverem-napáječem
- napájena bezprostředně sítovým napětím
- více než dvojnásobně snížená spotřeba při současném zvýšení světelné účinnosti
- vysoký index podání barev (Ra / CRI > 80) umožňuje široké spektrum použití
- vybraná teplota barvy světla (Tc / CCT 4200K) k zářivkám T8 o označení 840
- otočné patice (180°) umožňují seřízení ve svítidlech s různou orientací vnitřních objímek(0-90°)
- možná instalace bez nutnosti zásahu ve svítidlech s VVG předřadníkem

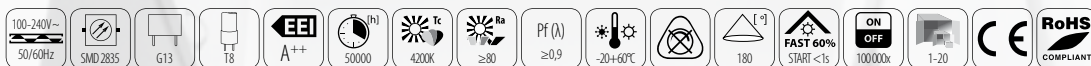
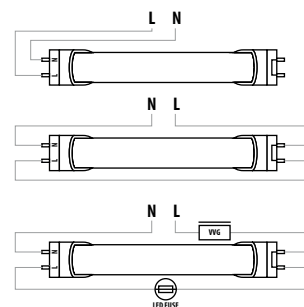
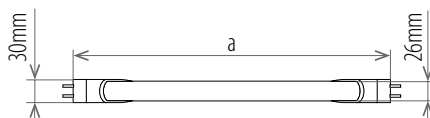

LED T8-840-10W/60cm	GXLT001	8592660108889	☐ bílá	72	10	48	1100	588	180	DKC
LED T8-840-22W/120cm	GXLT002	8592660108896	☐ bílá	144	22	100	2400	1198	330	899,- Kč
LED T8-840-25W/150cm	GXLT003	8592660108902	☐ bílá	168	25	120	2600	1500	430	1024,- Kč



DAISY LED24 SMD 5050 GU10 4W



Světelný zdroj LED SMD

- náhrada halogenových žárovek JDR/GU10
- vysoká účinnost - ekvivalent 30W
- o více než 85% nižší spotřeba energie
- nová technologie LED SMD (24 x LED SMD typu 5050)
- ochranné sklo
- životnost - 35 000 hodin

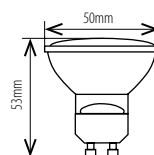

								DKC
DAISY LED24 SMD 5050 GU10 CW	GXDS001	8592660106489	<input type="checkbox"/> studená bílá	4	6500-7000K	270	≥80	143,- Kč
DAISY LED24 SMD 5050 GU10 WW	GXDS002	8592660106496	<input type="checkbox"/> teplá bílá	4	3000-3300K	250	≥80	143,- Kč

DAISY LED60 SMD 3528 GU10 4W



Světelný zdroj LED SMD

- náhrada halogenových žárovek JDR/GU10
- vysoká účinnost - ekvivalent 25W
- o 85% nižší spotřeba energie
- nová technologie LED SMD (60 x LED SMD typu 3528)
- ochranné sklo
- životnost - 35 000 hodin

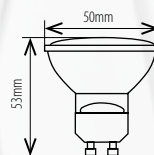

								DKC
DAISY LED60 SMD 3528 GU10 CW	GXDS003	8592660106526	<input type="checkbox"/> studená bílá	4	6500-7000K	220	≥80	106,- Kč
DAISY LED60 SMD 3528 GU10 WW	GXDS004	8592660106533	<input type="checkbox"/> teplá bílá	4	3000-3300K	200	≥80	106,- Kč

DAISY LED48 SMD 3528 GU10 3,5W



Světelný zdroj LED SMD

- náhrada halogenových žárovek JDR/GU10
- vysoká účinnosť - ekvivalent 20W
- o 85% nižšia spotreba energie
- nová technológia LED SMD (48 x LED SMD typu 3528)
- ochranné sklo
- životnosť - 35 000 hodín

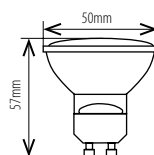
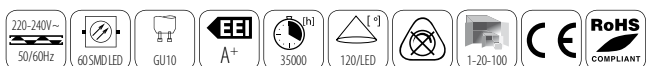

									DKC
DAISY LED48 SMD 3528 GU10 CW	GXDS005	8592660106502	<input type="checkbox"/> studená biela	3,5	6500-7000K	190	≥80	99,- Kč	
DAISY LED48 SMD 3528 GU10 WW	GXDS006	8592660106519	<input type="checkbox"/> teplá biela	3,5	3000-3300K	170	≥80	99,- Kč	

DAISY LED60 SMD 3528 MR16 4W



Světelný zdroj LED SMD

- náhrada halogenových žárovek MR16
- vysoká účinnosť - ekvivalent 25W
- o 85% nižšia spotreba energie
- nová technológia LED SMD (60 x LED SMD typu 3528)
- ochranné sklo
- životnosť - 35 000 hodín

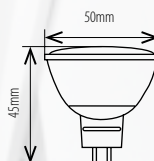

									DKC
DAISY LED60 SMD 3528 MR16 CW	GXDS007	8592660106540	<input type="checkbox"/> studená biela	4	6500-7000K	220	80	106,- Kč	
DAISY LED60 SMD 3528 MR16 WW	GXDS008	8592660106557	<input type="checkbox"/> teplá biela	4	3000-3300K	200	75	106,- Kč	



DAISY LED30 SMD 3528 GU10 1,8W



Světelný zdroj LED SMD

- náhrada halogenových žárovek JDR/GU10
- vysoká účinnost - ekvivalent 15W
- o 85% nižší spotřeba energie
- nová technologie LED SMD (30 x LED SMD typu 3528)
- ochranné sklo
- životnost - 35 000 hodin

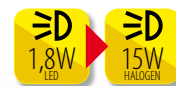
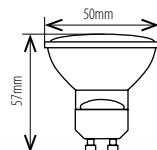

DAISY LED30 SMD 3528 GU10 WW	GXDS009	8592660106854	<input type="checkbox"/> teplá bílá	1,8	3000-3300K	100	75	106,- Kč

LED SMD 15W

NEW



Úsporná žárovka SMD LED

- náhrada za klasické žárovky 80W
- o více než 80% nižší spotřeba energie
- nová technologie LED SMD (30 x LED SMD typu 3016)
- životnost 30 000 hodin

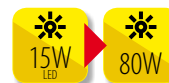
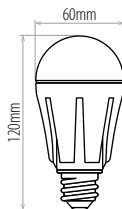

										DKC
LED SMD 15W CW	GXLZ141	8592660109206	studená bílá		15	6000K	1160	≥80	395,- Kč	
LED SMD 15W WW	GXLZ142	8592660109213	teplá bílá		15	3000K	1150	≥80	395,- Kč	

LED SMD 12W

NEW



Úsporná žárovka SMD LED

- náhrada za klasické žárovky 70W
- o více než 80% nižší spotřeba energie
- nová technologie LED SMD (24 x LED SMD typu 3016)
- životnost 30 000 hodin

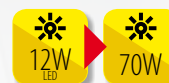
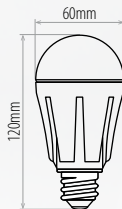

										DKC
LED SMD E27 12W CW	GXLZ156	8592660109374	studená bílá		12	6000K	960	≥80	329,- Kč	
LED SMD E27 12W WW	GXLZ157	8592660109381	teplá bílá		12	3000K	950	≥80	329,- Kč	

LED SMD 9W

NEW



Úsporná žárovka SMD LED

- náhrada za klasické žárovky 60W
- o více než 80% nižší spotřeba energie
- nová technologie LED SMD (20 x LED SMD typu 3016)
- životnost 30 000 hodin

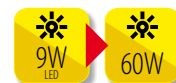
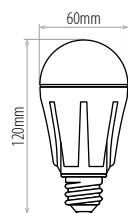

								DKC
LED SMD E27 9W CW	GXLZ158	8592660109411	studená bílá	<input type="checkbox"/> 9	6000K	860	≥80	239,- Kč
LED SMD E27 9W WW	GXLZ159	8592660109428	teplá bílá	<input type="checkbox"/> 9	3000K	850	≥80	239,- Kč

LED SMD 7W

NEW NEW SMD 2835



Úsporná žárovka SMD LED

- náhrada za klasické žárovky 50W
- o 85% nižší spotřeba energie
- nová technologie LED SMD (30 x LED SMD typu 2835)
- životnost 30 000 hodin

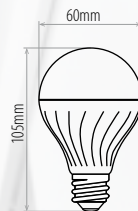

								DKC
LED SMD E27 7W CW	GXLZ160	8592660109398	studená bílá	<input type="checkbox"/> 7	6200K	600	≥80	179,- Kč
LED SMD E27 7W WW	GXLZ161	8592660109404	teplá bílá	<input type="checkbox"/> 7	3000K	580	≥80	179,- Kč

LED SMD CL E27



Úsporná žárovka LED

- o 85% nižší spotřeba energie ve srovnání s běžným typem osvětlení
- vhodné do svítidel typu DOWNLIGHT
- regulovatelná objímka - lze nastavit směr toku světla
- nová technologie - diody SMD LED typu 3014
- 60 nebo 100 diod LED odpovídajících verzi 6W a 10W
- životnost 40000 hodin

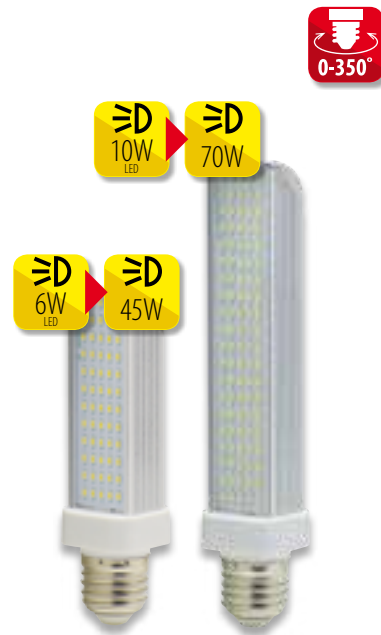
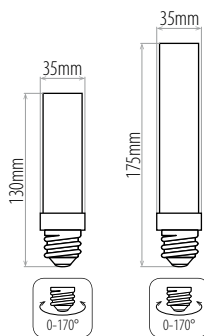

									DKC
LED60 SMD CL E27 6W - CW	GXLZ071	8592660105734	<input type="checkbox"/> studená bílá	6	6500K	570	≥80	80g	369,- Kč
LED60 SMD CL E27 6W - WW	GXLZ070	8592660105727	<input type="checkbox"/> teplá bílá	6	3000K	540	≥80	80g	369,- Kč
LED100 SMD CL E27 10W - CW	GXLZ073	8592660105758	<input type="checkbox"/> studená bílá	10	6500K	950	≥80	110g	495,- Kč
LED100 SMD CL E27 10W - WW	GXLZ072	8592660105741	<input type="checkbox"/> teplá bílá	10	3000K	900	≥80	110g	495,- Kč

LED SMD PLC G24d



Úsporná žárovka LED

- 85% nižší spotřeba energie ve srovnání s běžným typem osvětlení
- vhodné do svítidel typu DOWNLIGHT
- regulovatelná objímka - lze nastavit směr toku světla
- nová technologie - diody SMD LED typu 3014
- 60 nebo 100 diod LED odpovídajících verzi 6W i 10W
- životnost 40000 hodin

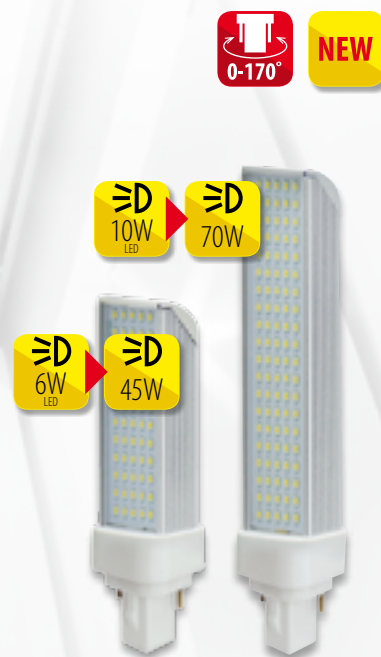
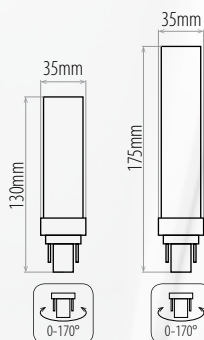

									DKC
LED60 SMD PLC G24d 6W - CW	GXLZ147	8592660109268	<input type="checkbox"/> studená bílá	10	6500K	950	≥80	110g	369,- Kč
LED60 SMD PLC G24d 6W - WW	GXLZ148	8592660109275	<input type="checkbox"/> teplá bílá	10	3000K	900	≥80	110g	369,- Kč
LED100 SMD PLC G24d 10W - CW	GXLZ149	8592660109282	<input type="checkbox"/> studená bílá	6	6500K	570	≥80	80g	495,- Kč
LED100 SMD PLC G24d 10W - WW	GXLZ150	8592660109299	<input type="checkbox"/> teplá bílá	6	3000K	540	≥80	80g	495,- Kč

LED SVÍTIDLA

HALO MCOB



HALO MCOB 100W



HALO MCOB 50W

HALO MCOB 30W

HALO MCOB 10W

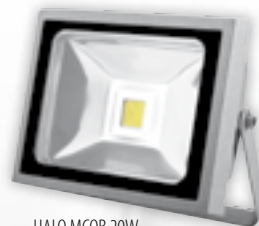

HALO MCOB 20W

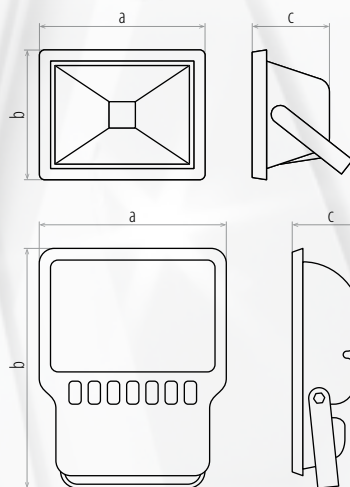
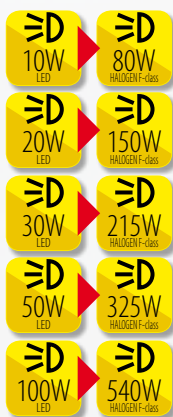

Energeticky úsporný reflektor LED MCOB

- tělo z hliníkové slitiny
- ochranné bezpečnostní tvrzené sklo s šířkou 5mm
- prachotěsný, voděodolný
- nejnovější technologie MCOB (Multi Chips on Board)
- výrazně nižší spotřeba energie než běžné halogenové reflektory
- vysoká světelná účinnost



						a [mm]	b [mm]	c [mm]			DKC
HALO MCOB 10W	GXLS025	8592660104232	<input type="checkbox"/> studená bílá	10	750	115	86	75	410	1-20	396,- Kč
HALO MCOB 20W	GXLS051	8592660106588	<input type="checkbox"/> studená bílá	20	1700	180	141	92	880	1-6	809,- Kč
HALO MCOB 30W	GXLS026	8592660104249	<input type="checkbox"/> studená bílá	30	2500	224	185	96	1450	1-2	1133,- Kč
HALO MCOB 50W	GXLS027	8592660104256	<input type="checkbox"/> studená bílá	50	4000	290	236	100	1950	1-2	1760,- Kč
HALO MCOB 100W	GXLS043	8592660105314	<input type="checkbox"/> studená bílá	100	7000	330	430	120	6800	1-2	6599,- Kč

TOMI MCOB

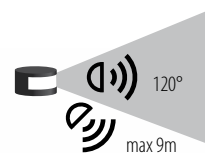

10W LED	80W HALOGEN F-glass
20W LED	150W HALOGEN F-glass
30W LED	215W HALOGEN F-glass

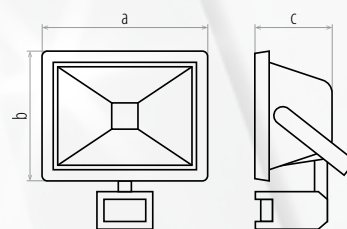

Energeticky úsporný reflektor LED MCOB s čidlem pohybu

- tělo z hliníkové slitiny
- ochranné bezpečnostní tvrzené sklo s šířkou 5mm
- prachotěsný, voděodolný
- nejnovější technologie MCOB (Multi Chips on Board)
- výrazně nižší spotřeba energie než běžné halogenové reflektory
- vysoká světelná účinnost

220-240V~ 50/60Hz	MCOB LED	6000-6500K	0,5	50000	75	-15+35°C	F	IP 44	CE	RoHS COMPLIANT
----------------------	----------	------------	-----	-------	----	----------	---	-------	----	----------------

+ TIME - 5s-7min	+ SENS - 1-9m	+ LUX - 3-2000	max 9m	180°
---------------------	------------------	-------------------	--------	------

							a [mm]	b [mm]	c [mm]			DKC
TOMI MCOB 10W	GXLS054	8592660108070	<input type="checkbox"/>	studená bílá	10	750	115	86	75	500	1-8	707,- Kč
TOMI MCOB 20W	GXLS055	8592660108087	<input type="checkbox"/>	studená bílá	20	1700	180	141	92	1000	1-6	1106,- Kč
TOMI MCOB 30W	GXLS056	8592660108094	<input type="checkbox"/>	studená bílá	30	2500	224	185	96	1600	1-6	1455,- Kč

STAT



Stojany pro svítidla typu MCOB

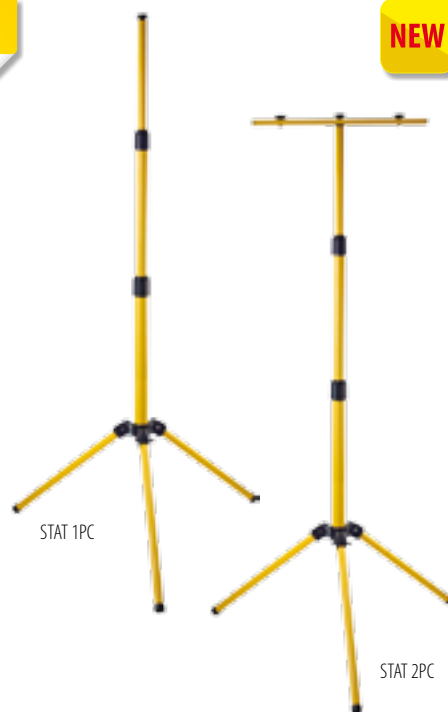
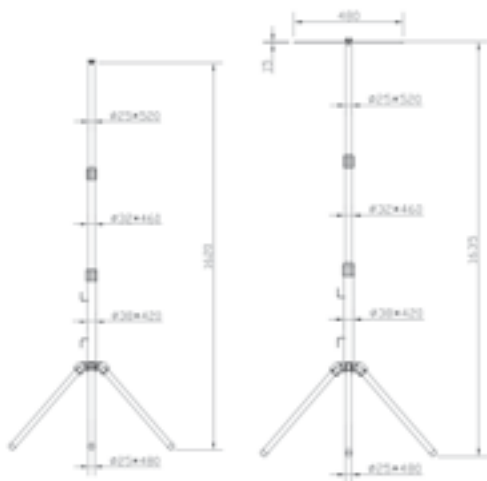

NEW



STAT 1PC

STAT 2PC



GXLS057

GXLS058



8592660108100

8592660108117

DKC

649,- Kč

721,- Kč

STAND



Stojany pro svítidla typu MCOB



NEW



STAND-S 10

STAND-S 20

STAND-H 30



GXLS059

GXLS060

GXLS061



8592660108667

8592660108674

8592660108681

DKC

147,- Kč

168,- Kč

299,- Kč



LED LYRA



Vestavné LED svítidlo

těleso: lakovaný hliník v bílé barvě
difuzor: sklo

- o 85 % nižší spotřeba energie ve srovnání s běžným osvětlením
- o 20 % nižší spotřeba energie ve srovnání s zářivkovými svítidly třídy A
- moderní technologie – vysoce výkonný MCOB LED
- napájení (LED DRIVER) součástí dodávky
- životnost 50 000 hodin

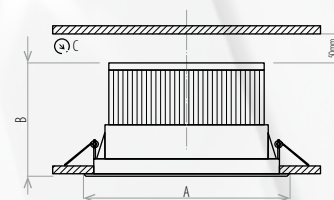
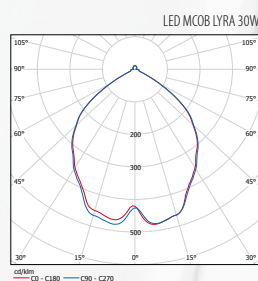
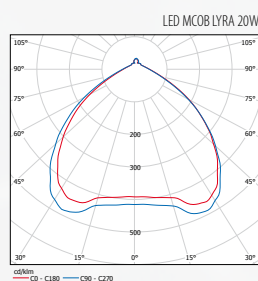
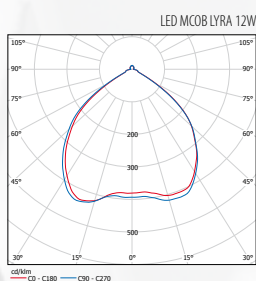

							a [mm]	b [mm]	c [mm]			DKC
LED MCOB LYRA White 12W CW	GXDW022	8592660106755	<input type="checkbox"/> studená bílá	12	6000K	800	165	75	145	500	1-12	1032,- Kč
LED MCOB LYRA White 12W WW	GXDW023	8592660106762	<input type="checkbox"/> teplá bílá	12	3000K	700	165	75	145	500	1-12	1032,- Kč
LED MCOB LYRA White 20W CW	GXDW026	8592660106793	<input type="checkbox"/> studená bílá	20	6000K	1400	195	90	170	2900	1-12	1384,- Kč
LED MCOB LYRA White 20W WW	GXDW027	8592660106809	<input type="checkbox"/> teplá bílá	20	3000K	1200	195	90	170	2900	1-12	1384,- Kč
LED MCOB LYRA White 30W CW	GXDW030	8592660106830	<input type="checkbox"/> studená bílá	30	6000K	2400	225	105	210	5700	1-8	2109,- Kč
LED MCOB LYRA White 30W WW	GXDW031	8592660106847	<input type="checkbox"/> teplá bílá	30	3000K	2200	225	105	210	5700	1-8	2109,- Kč

LED FENIX ROUND



Prísazené LED svítidlo

- těleso: lakovaný hliník
- difuzor: matný, akrylát (PMMA)
- o 85 % nižší spotřeba energie ve srovnání s běžným osvětlením
- o 20 % nižší spotřeba energie ve srovnání s zářivkovými svítidly třídy A
- moderní technologie – vysoce výkonné diody SMD LED
- 90 diod LED typu SMD 2835
- napájení (LED DRIVER) součástí dodávky
- životnost 30 000 hodin

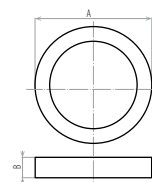
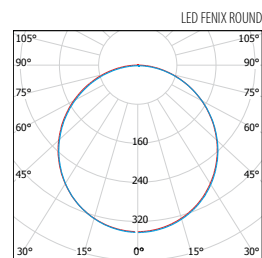

LED90 FENIX-R Silver 18W CW	GXDW037	8592660107677	<input checked="" type="checkbox"/> stříbrná	<input type="checkbox"/> studená bílá	18	6500K	1450	80	255	35	75	1-15	1234,- Kč		
LED90 FENIX-R Silver 18W WW	GXDW036	8592660107660	<input checked="" type="checkbox"/> stříbrná	<input type="checkbox"/> teplá bílá	18	3500K	1450	75	255	35	75	1-15	1234,- Kč		
LED90 FENIX-R White 18W CW	GXDW033	8592660107110	<input type="checkbox"/> bílá	<input type="checkbox"/> studená bílá	18	6500K	1450	80	225	35	75	1-15	1234,- Kč		
LED90 FENIX-R White 18W WW	GXDW032	8592660107103	<input type="checkbox"/> bílá	<input type="checkbox"/> teplá bílá	18	3500K	1450	75	225	35	75	1-15	1234,- Kč		

LED FENIX SQUARE



Prísazené LED svítidlo

- těleso: lakovaný hliník
- difuzor: matný, akrylát (PMMA)
- o 85 % nižší spotřeba energie ve srovnání s běžným osvětlením
- o 20 % nižší spotřeba energie ve srovnání s zářivkovými svítidly třídy A
- moderní technologie – vysoce výkonné diody SMD LED
- 90 diod LED typu SMD 2835
- napájení (LED DRIVER) součástí dodávky
- životnost 30 000 hodin

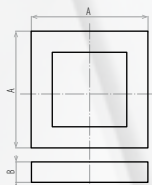
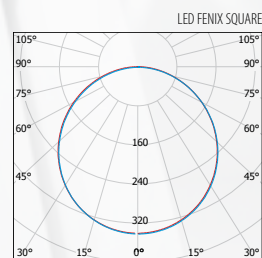

LED90 FENIX-S Silver 18W CW	GXDW039	8592660107691	<input checked="" type="checkbox"/> stříbrná	<input type="checkbox"/> studená bílá	18	6500K	1450	80	225	35	85	1-15	1234,- Kč		
LED90 FENIX-S Silver 18W WW	GXDW038	8592660107684	<input checked="" type="checkbox"/> stříbrná	<input type="checkbox"/> teplá bílá	18	3500K	1450	75	225	35	85	1-15	1234,- Kč		
LED90 FENIX-S White 18W CW	GXDW035	8592660107134	<input type="checkbox"/> bílá	<input type="checkbox"/> studená bílá	18	6500K	1450	80	225	35	85	1-15	1234,- Kč		
LED90 FENIX-S White 18W WW	GXDW034	8592660107127	<input type="checkbox"/> bílá	<input type="checkbox"/> teplá bílá	18	3500K	1450	75	225	35	85	1-15	1234,- Kč		

LED SCALEA FARO

NEW



LED svítidlo

těleso: lakovaná ocel v bílé barvě

difuzor: matný akrylát (PMMA)

- více než o 80% nižší spotřeba energie ve srovnání s běžným typem osvětlení

- více než o 15% nižší spotřeba energie ve srovnání s svítidly třídy A

- nová technologie – vysoce výkonné diody LED SMD

- 30 nebo 48 diod LED typu SMD 5730 odpovídajících verzím 15W a 24W

- napájení (LED DRIVER) součástí dodávky

- životnost: 30 000 hodin

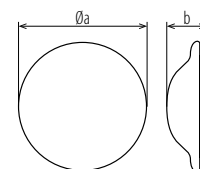

								a [mm]	b [mm]			DKC
LED SCALEA FARO 15W CW	GXLS070	8592660108735	30	<input type="checkbox"/> studená bílá	15	6500K	1200	360	100	950	1-10	722,- Kč
LED SCALEA FARO 15W WW	GXLS071	8592660108742	30	<input type="checkbox"/> teplá bílá	15	3000K	1200	360	100	950	1-10	722,- Kč
LED SCALEA FARO 24W CW	GXLS072	8592660108759	48	<input type="checkbox"/> studená bílá	24	6500K	1850	405	100	1200	1-10	1109,- Kč
LED SCALEA FARO 24W WW	GXLS073	8592660108766	48	<input type="checkbox"/> teplá bílá	24	3000K	1850	405	100	1200	1-10	1109,- Kč

LED SCALEA LAURO

NEW



LED svítidlo

těleso: lakovaná ocel v bílé barvě

difuzor: matný akrylát (PMMA)

- více než 80% nižší spotřeba energie ve srovnání s běžným typem osvětlení

- více než 15% nižší spotřeba energie ve srovnání s svítidly třídy A

- nová technologie – vysoce výkonné diody LED SMD

- 30 nebo 48 diod LED typu SMD 5730 odpovídajících verzím 15W a 24W

- napájení (LED DRIVER) součástí dodávky

- životnost: 30 000 hodin

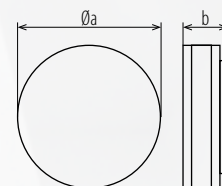

								a [mm]	b [mm]			DKC
LED SCALEA LAURO 15W CW	GXLS074	8592660108698	30	<input type="checkbox"/> studená bílá	15	6500K	1200	345	85	1000	1-10	777,- Kč
LED SCALEA LAURO 15W WW	GXLS075	8592660108704	30	<input type="checkbox"/> teplá bílá	15	3000K	1200	345	85	1000	1-10	777,- Kč
LED SCALEA LAURO 24W CW	GXLS076	8592660108711	48	<input type="checkbox"/> studená bílá	24	6500K	1850	395	85	1300	1-10	1164,- Kč
LED SCALEA LAURO 24W WW	GXLS077	8592660108728	48	<input type="checkbox"/> teplá bílá	24	3000K	1850	395	85	1300	1-10	1164,- Kč

LED SCALEA FARO HF



LED svítidlo s mikrovlnným senzorem

- těleso: lakovaná ocel v bílé barvě
difuzor: matný akrylát (PMMA)
- vestavěné mikrovlnné čidlo
 - možnost průběžného propojení
 - více než 80% nižší spotřeba energie ve srovnání s běžným typem osvětlení
 - více než 15% nižší spotřeba energie ve srovnání s svítilny třídy A
 - nová technologie – vysoce výkonné diody LED SMD
 - 48 diod LED typu SMD 5730
 - napájení (LED DRIVER) součástí dodávky
 - životnost: 30 000 hodin



NEW

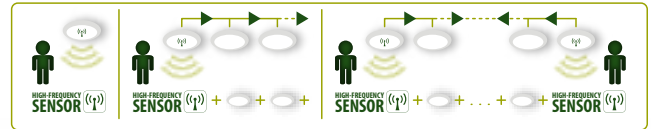
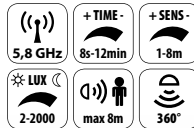
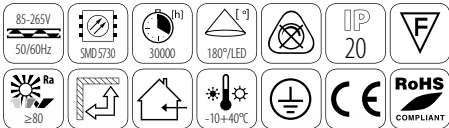
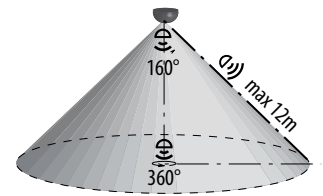
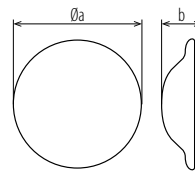

								a [mm]	b [mm]			DKC
LED SCALEA FARO HF 24W WW	GXLS085	8592660108858	48	☐ teplá bílá	24	3000K	1850	405	100	1250	1-10	1725,- Kč

LED SCALEA LAURO HF



LED svítidlo s mikrovlnným senzorem

- těleso: lakovaná ocel v bílé barvě
difuzor: matný akrylát (PMMA)
- vestavěné mikrovlnné čidlo
 - možnost průběžného propojení
 - více než 80% nižší spotřeba energie ve srovnání s běžným typem osvětlení
 - více než 15% nižší spotřeba energie ve srovnání s svítilny třídy A
 - nová technologie – vysoce výkonné diody LED SMD
 - 48 diod LED typu SMD 5730
 - napájení (LED DRIVER) součástí dodávky
 - životnost: 30 000 hodin



NEW

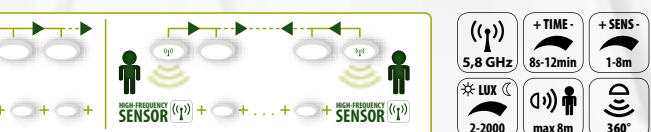
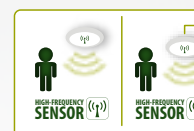
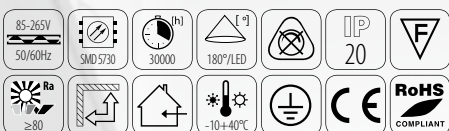
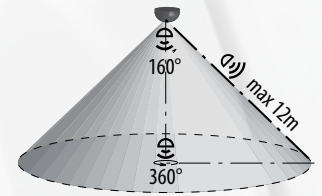
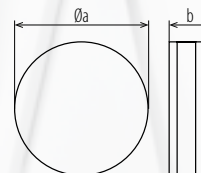

								a [mm]	b [mm]			DKC
LED SCALEA LAURO HF 24W WW	GXLS081	8592660108810	48	☐ teplá bílá	24	3000K	1850	395	85	1350	1-10	1830,- Kč

LED KABINET

Podlínkové svítidlo LED

- těleso: hliník
difuzor: matný polykarbonát (PC)
- moderní technologie – vysoce výkonné diody SMD LED 3014
 - téměř 2x nižší spotřeba energie než svítidla se zářivkami T5
 - zabudované napájení LED (LED DRIVER)
 - průběžné zapojení
 - součástí svítidla je vypínač
 - životnost 30 000 hodin

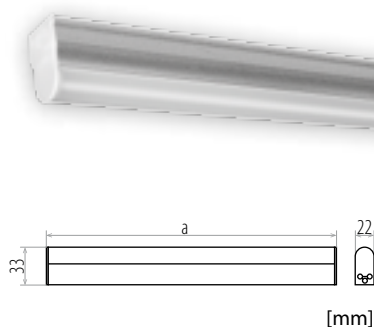

								a [mm]		DKC
LED KABINET 4W CW	GXKA002	8592660106649	<input type="checkbox"/> studená bílá	4W	40	6400+/150K	360	282	105	504,- Kč
LED KABINET 4W WW	GXKA001	8592660106632	<input type="checkbox"/> teplá bílá	4W	40	3100+/150K	360	282	105	504,- Kč
LED KABINET 7W CW	GXKA004	8592660106663	<input type="checkbox"/> studená bílá	7W	70	6400+/150K	600	494	145	658,- Kč
LED KABINET 7W WW	GXKA003	8592660106656	<input type="checkbox"/> teplá bílá	7W	70	3100+/150K	600	494	145	658,- Kč
LED KABINET 13W CW	GXKA006	8592660106687	<input type="checkbox"/> studená bílá	13W	130	6400+/150K	1100	994	250	999,- Kč
LED KABINET 13W WW	GXKA005	8592660106670	<input type="checkbox"/> teplá bílá	13W	130	3100+/150K	1100	994	250	999,- Kč
LED KABINET 15W CW	GXKA008	8592660106700	<input type="checkbox"/> studená bílá	15W	150	6400+/150K	1250	1144	285	1099,- Kč
LED KABINET 15W WW	GXKA007	8592660106694	<input type="checkbox"/> teplá bílá	15W	150	3100+/150K	1250	1144	285	1099,- Kč

Příslušenství



Připojovací kabely k svítidlům LED KABINET



			d [cm]		DKC
LED KABINET connector	GXKA009	8592660106717	24	1-150	20,- Kč
LED KABINET 1,2m Plug	GXKA010	8592660106724	115	1-100	109,- Kč

LED STRIP 2835 IP65



Lineární moduly LED

- délka: 5 a 30 metrů
- možnost dělení na části (50mm = 3xLED)
- voděodolné

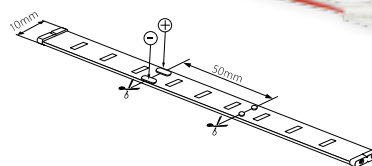
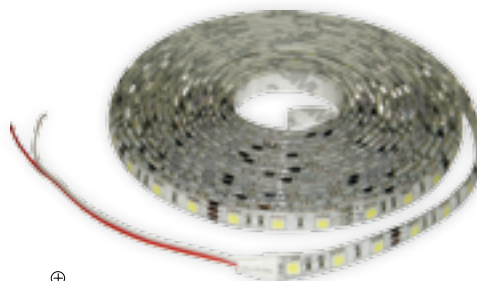

									DKC
LED STRIP 2835 IP65 CW 5m	GXLS062	8592660108353	300	<input type="checkbox"/> studená bílá	5000-6000 K	12	5	1040	1559,- Kč
LED STRIP 2835 IP65 WW 5m	GXLS063	8592660108360	300	<input type="checkbox"/> teplá bílá	2700-3500 K	12	5	1000	1559,- Kč
LED STRIP 2835 IP65 CW 30m	GXLS052	8592660108339	1800	<input type="checkbox"/> studená bílá	5000-6000 K	12	30	1040	7920,- Kč
LED STRIP 2835 IP65 WW 30m	GXLS053	8592660108346	1800	<input type="checkbox"/> teplá bílá	2700-3500 K	12	30	1000	7920,- Kč

LED STRIP 2835



Lineární moduly LED

- délka: 5 metrů
- možnost dělení na části (50mm = 3xLED)

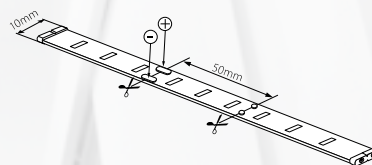

								DKC
LED STRIP 2835 IP20 CW	GXLS064	8592660108377	300	<input type="checkbox"/> studená bílá	5000-6000 K	12	1040	1399,- Kč
LED STRIP 2835 IP20 WW	GXLS065	8592660108384	300	<input type="checkbox"/> teplá bílá	2700-3500 K	12	1000	1399,- Kč

LED STRIP 3528 IP65



Lineární moduly LED

- délka: 5 metrů
- možnost dělení na části (50mm = 3xLED)
- voděodolné

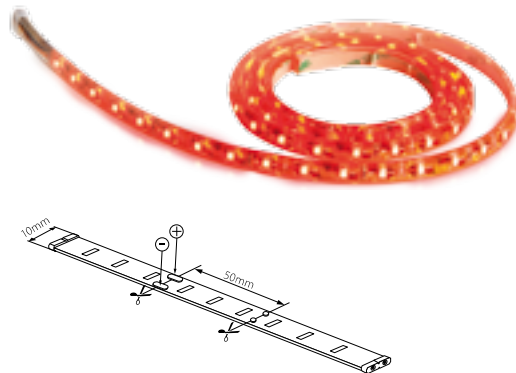

								DKC
LED STRIP 5m IP65 RE	GXLS011	8592660102887	300	<input checked="" type="checkbox"/> červená	-	4,8	-	478,- Kč
LED STRIP 5m IP65 BL	GXLS014	8592660102917	300	<input checked="" type="checkbox"/> modrá	-	4,8	-	478,- Kč
LED STRIP 5m IP65 GN	GXLS015	8592660102924	300	<input checked="" type="checkbox"/> zelená	-	4,8	-	478,- Kč
LED STRIP 5m IP65 CW	GXLS016	8592660102931	300	<input type="checkbox"/> studená bílá	5000-6000K	4,8	240	478,- Kč
LED STRIP 5m IP65 WW	GXLS017	8592660102948	300	<input type="checkbox"/> teplá bílá	2700-3500K	4,8	210	478,- Kč

LED STRIP 3528



Lineární moduly LED

- délka: 5 metrů
- možnost dělení na části (50mm = 3xLED)



								DKC
LED STRIP 5m CW	GXLS009	8592660102863	300	<input type="checkbox"/> studená bílá	5000-6000K	4,8	240	320,- Kč
LED STRIP 5m WW	GXLS010	8592660102870	300	<input type="checkbox"/> teplá bílá	2700-3500K	4,8	210	320,- Kč

LED STRIP RGB 5050 IP65



Lineární moduly LED

- délka: 5 metrů
- možnost dělení na části (50mm = 3xLED)
- voděodolné

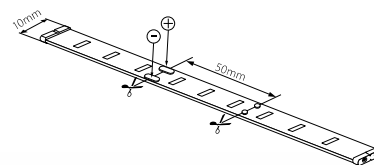
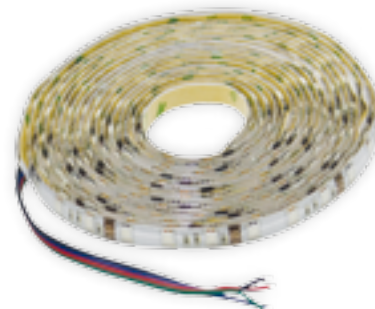

						DKC
LED STRIP RGB 5050 IP65 5m	GXLS045	8592660105772	300	RGB	14,4	1699,- Kč

LED STRIP RGB 5050

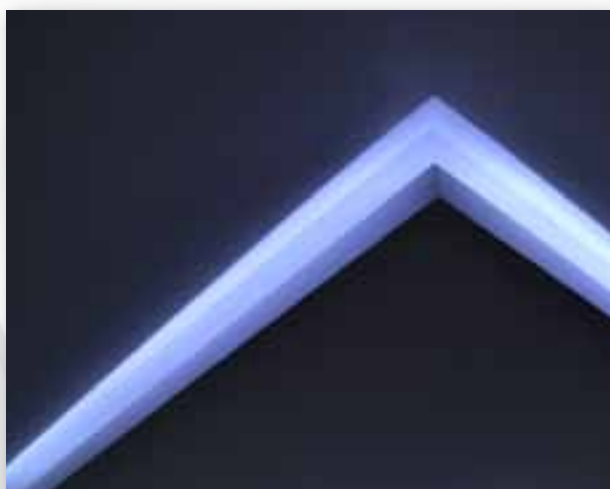

Lineární moduly LED

- délka: 5 metrů
- možnost dělení na části (50mm = 3xLED)

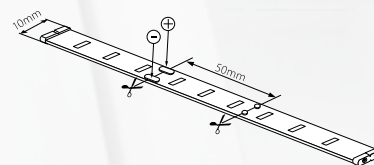

						DKC
LED STRIP RGB 5050	GXLS044	8592660105765	300	RGB	14,4	1499,- Kč

RGB LED CONTROLLER



Bezdrátový RGB LED Controller

- Kontrolér je řízen rádiovým signálem
- funkce změny barvy
- programovatelné režimy
- funkce stmívání



RGB LED CONTROLLER



GXLS046



8592660105598

DKC

549,- Kč

KONEKT - LED RGB STRIP



Čtyřpinový plastový propojovací konektor

- Určené pro elektrické propojení RGB LED modulů
- (T+T) k propojení samostatných oddělených RGB LED modulů
- (T+P) pro připojení externímu zařízení - zdroji



CONNECT LED RGB STRIP 10mm T+T

CONNECT LED RGB STRIP 12mm T+T

CONNECT LED RGB STRIP 10mm T+P

CONNECT LED RGB STRIP 12mm T+P



GXLS048

GXLS050

GXLS047

GXLS049



8592660105611

8592660105635

8592660105604

8592660105628

DKC

20,- Kč

25,- Kč

35,- Kč



38,- Kč

KONEKT - LED STRIP

**Dvoupinový plastový propojovací konektor**

Konektory jsou určeny pro elektrické připojení a napájení 2-pin LED pásků o šířce 8, 10 a 12 mm
 - (T+T) k propojení samostatných oddělených LED modulů
 - (T+P) pro připojení k napájení



			DKC
CONNECT LED STRIP 8mm/2P T+T	GXLS035	8592660104829	19,- Kč
CONNECT LED STRIP 10mm/2P T+T	GXLS041	8592660105079	19,- Kč
CONNECT LED STRIP 12mm/2P T+T	GXLS036	8592660104836	29,- Kč
CONNECT LED STRIP 8mm/2P T+P	GXLS037	8592660104843	19,- Kč
CONNECT LED STRIP 10mm/2P T+P	GXLS042	8592660105086	29,- Kč
CONNECT LED STRIP 12mm/2P T+P	GXLS038	8592660104850	29,- Kč



Vestavné LED svítidlo

těleso svítidla: hliník
montážní krabice: plast

- energeticky úsporné SMD LED svítidlo
- připojení přímo do sítě 230V
- vestavné LED napájení uvnitř svítidla
- montážní krabice je součástí



WALL 30 3W GRAY WW



WALL 20 3W SILVER WW



WALL 10 1,5W GRAY CW

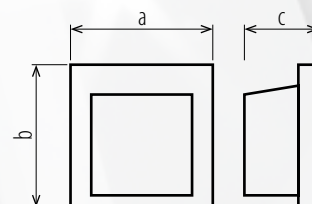

								a [mm]	b [mm]	c [mm]	DKC
WALL 10 1,5W GRAY CW	GXLL002	8592660108964	šedá	15 x SMD 3528	studená bílá	1,5	6000K	90	90	46	610,- Kč
WALL 10 1,5W GRAY WW	GXLL008	8592660109701	šedá	15 x SMD 3528	teplá bílá	1,5	3000K	90	90	46	610,- Kč
WALL 20 3W GRAY CW	GXLL004	8592660108988	šedá	15 x SMD 5050	studená bílá	3	6000K	140	70	48	689,- Kč
WALL 20 3W GRAY WW	GXLL010	8592660109725	šedá	15 x SMD 5050	teplá bílá	3	3000K	140	70	48	689,- Kč
WALL 30 3W GRAY CW	GXLL006	8592660109008	šedá	15 x SMD 5050	studená bílá	3	6000K	140	140	51	854,- Kč
WALL 30 3W GRAY WW	GXLL012	8592660109749	šedá	15 x SMD 5050	teplá bílá	3	3000K	140	140	51	854,- Kč

TECHNICKÁ SVÍTIDLA



DUST LED PC



LED Svítidlo prachotěsné

těleso svítidla: ABS
difuzor: polykarbonát
napájení: jednostranné

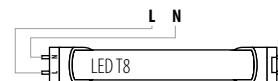

				a [mm]	b [mm]	c [mm]			DKC
DUST LED PC 1xT8/60cm	GXWP090	8592660109893	šedá	660	100	95	800	1-10-100	338,- Kč
DUST LED PC 1xT8/120cm	GXWP091	8592660109909	šedá	660	140	95	1090	1-8-120	435,- Kč
DUST LED PC 1xT8/150cm	GXWP092	8592660109916	šedá	1265	100	95	1430	1-6-120	589,- Kč
DUST LED PC 2xT8/60cm	GXWP093	8592660109923	šedá	1265	140	95	1700	1-6-84	432,- Kč
DUST LED PC 2xT8/120cm	GXWP094	8592660109930	šedá	1565	100	95	2300	1-6-72	538,- Kč
DUST LED PC 2xT8/150cm	GXWP095	8592660109947	šedá	1565	140	95	2500	1-4-60	743,- Kč

DUST

LED

Svítlidlo prachotěsné

těleso svítidla: ABS
difuzor: polykarbonát; polystyren (PS)
předřadník: elektronický (EVG); indukční (VVG)
- pětiletá záruka na předřadník EB

Verze s nouzovým modulem

- osvětlení s nouzovým modulem a baterií
- LED indikace nouzového modulu
- funkční při havárii sítě
- vybaveno testovacím tlačítkem

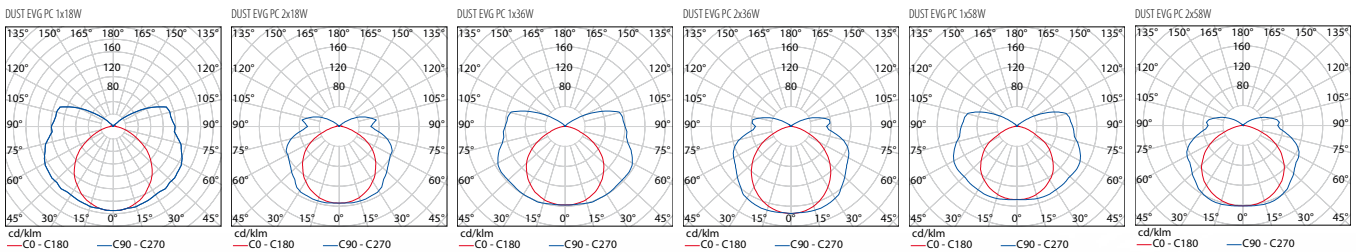
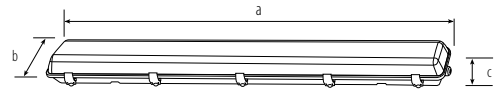

						a [mm]	b [mm]	c [mm]			DKC
DUST VVG PC 1x18W	GXWP007	8592660102405	1x18	VVG	PC	660	100	95	1300	1-10-150	245,- Kč
DUST VVG PC 2x18W	GXWP008	8592660102412	2x18	VVG	PC	660	135	95	1450	1-8-120	380,- Kč
DUST VVG PC 1x36W	GXWP009	8592660102429	1x36	VVG	PC	1265	100	95	1750	1-6-120	330,- Kč
DUST VVG PC 2x36W	GXWP010	8592660102436	2x36	VVG	PC	1265	140	95	2600	1-6-84	470,- Kč
DUST VVG PC 1x58W	GXWP011	8592660102443	1x58	VVG	PC	1565	1000	95	2450	1-6-72	500,- Kč
DUST VVG PC 2x58W	GXWP012	8592660102450	2x58	VVG	PC	1565	140	95	3750	1-4-60	740,- Kč

						a [mm]	b [mm]	c [mm]			DKC
DUST VVG PS 1x18W	GXWP015	8592660102504	1x18	VVG	PS	660	100	95	1300	1-10-150	231,- Kč
DUST VVG PS 2x18W	GXWP016	8592660102511	2x18	VVG	PS	660	135	95	1450	1-8-120	365,- Kč
DUST VVG PS 1x36W	GXWP017	8592660102528	1x36	VVG	PS	1265	100	95	1750	1-6-120	310,- Kč
DUST VVG PS 2x36W	GXWP018	8592660102535	2x36	VVG	PS	1265	140	95	2600	1-6-84	420,- Kč
DUST VVG PS 1x58W	GXWP019	8592660102542	1x58	VVG	PS	1565	1000	95	2450	1-6-72	450,- Kč
DUST VVG PS 2x58W	GXWP020	8592660102559	2x58	VVG	PS	1565	140	95	3750	1-4-60	680,- Kč

								a [mm]	b [mm]	c [mm]			DKC
DUST EVG PC 1x36W emergency	GXWP057	8592660107042	1x36	EVG	PC	1500	1:19	1265	100	95	2030	1-6-120	1497,- Kč
DUST EVG PC 1x58W emergency	GXWP058	8592660107059	1x58	EVG	PC	1800	1:20	1565	100	95	2900	1-6-72	1859,- Kč
DUST EVG PC 2x36W emergency	GXWP036	8592660107011	2x36	EVG	PC	1500	1:19	1265	140	95	2300	1-6-84	1721,- Kč
DUST EVG PC 2x58W emergency	GXWP047	8592660107028	2x58	EVG	PC	1800	1:20	1565	140	95	3100	1-4-60	2088,- Kč
DUST EVG PS 2x36W emergency	GXWP052	8592660107035	2x36	EVG	PS	1500	1:19	1265	140	95	2300	1-6-84	1696,- Kč
DUST EVG PS 2x58W emergency	GXWP035	8592660107004	2x58	EVG	PS	1800	1:20	1575	140	95	3100	1-4-60	2104,- Kč
DUST VVG PC 1x36W emergency	GXWP048	8592660108001	1x36	VVG	PC	1500	1:19	1265	100	95	2530	1-6-120	1537,- Kč
DUST VVG PC 1x58W emergency	GXWP050	8592660107936	1x58	VVG	PC	1800	1:20	1565	100	95	3300	1-6-72	1919,- Kč
DUST VVG PC 2x36W emergency	GXWP049	8592660108018	2x36	VVG	PC	1500	1:19	1265	140	95	2500	1-6-84	1657,- Kč
DUST VVG PC 2x58W emergency	GXWP051	8592660107943	2x58	VVG	PC	1800	1:20	1565	140	95	3400	1-4-60	2157,- Kč
DUST VVG PS 1x36W emergency	GXWP053	8592660107950	1x36	VVG	PS	1500	1:19	1265	100	95	2530	1-6-120	1513,- Kč
DUST VVG PS 1x58W emergency	GXWP055	8592660107974	1x58	VVG	PS	1800	1:20	1565	100	95	3300	1-6-72	1782,- Kč
DUST VVG PS 2x36W emergency	GXWP054	8592660107967	2x36	VVG	PS	1500	1:19	1265	140	95	2600	1-6-84	1604,- Kč
DUST VVG PS 2x58W emergency	GXWP056	8592660107981	2x58	VVG	PS	1800	1:20	1565	140	95	3400	1-4-60	2017,- Kč

TRUST EVG PS

Svítilno prachotěsné

těleso svítidla: ABS

difuzor: polystyren (PS)

předřadník: elektronický (EVG)

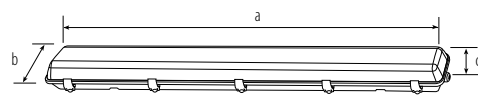
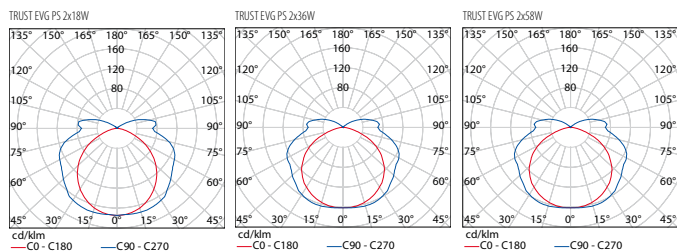
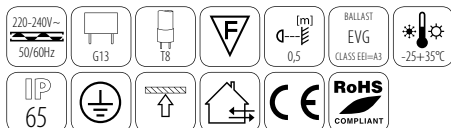

					a [mm]	b [mm]	c [mm]			DKC
TRUST EVG PS 2x18W	GXWP032	8592660105345	šedá	2x18	655	110	85	1200	1-10	343,- Kč
TRUST EVG PS 2x36W	GXWP033	8592660105352	šedá	2x36	1260	110	85	2000	1-8	438,- Kč
TRUST EVG PS 2x58W	GXWP034	8592660105369	šedá	2x58	1565	110	85	2350	1-8	636,- Kč



DUST METAL



Svítlidlo prachotěsné

těleso svítidla: hliník
difuzor: sklo
předřadník: elektronický, magnetický
- vhodné do prostor s vysokým zatížením

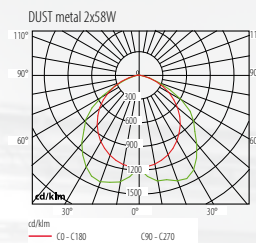
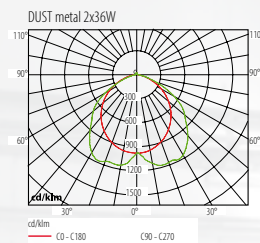
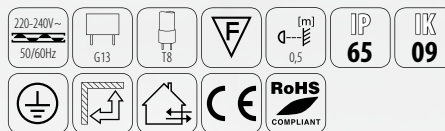
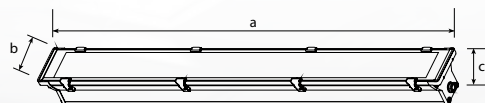

							a [mm]	b [mm]	c [mm]			DKK	
DUST metal EVG 2x36W	GXWP004	8592660101026	šedá	2 x 36	-15+50°C	EVG / EEI=A2	1285	150	95	5450	1-3	1460,- Kč	
DUST metal EVG 2x58W	GXWP025	8592660105178	šedá	2 x 58	-15+50°C	EVG / EEI=A2	1600	150	95	6490	1-3	1729,- Kč	
							a [mm]	b [mm]	c [mm]			DKK	
DUST metal VVG 2x36W	GXWP076	8592660109343	šedá	2 x 36	-20+35°C	+35°+70°C	VVG / EEI=B2	1285	150	95	6450	1-3	1899,- Kč
DUST metal VVG 2x58W	GXWP077	8592660109350	šedá	2 x 58	-20+35°C	+35°+70°C	VVG / EEI=B2	1600	150	95	7490	1-3	2399,- Kč

ORI LED

NEW LED

Svítilno zářivkové přisazené LED

těleso svítidla: ocelový plech
reflektor: poniklovaný plech
napájení: jednostranné

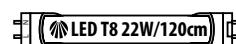
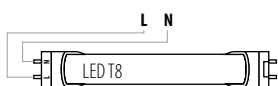
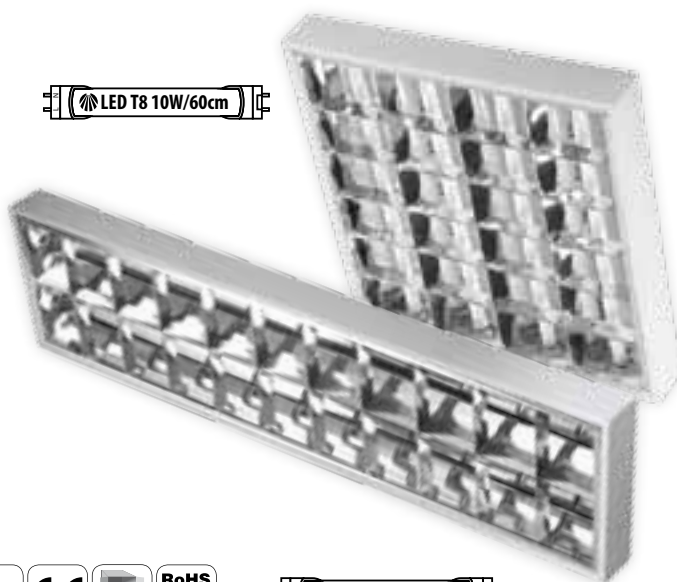
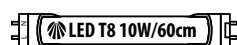
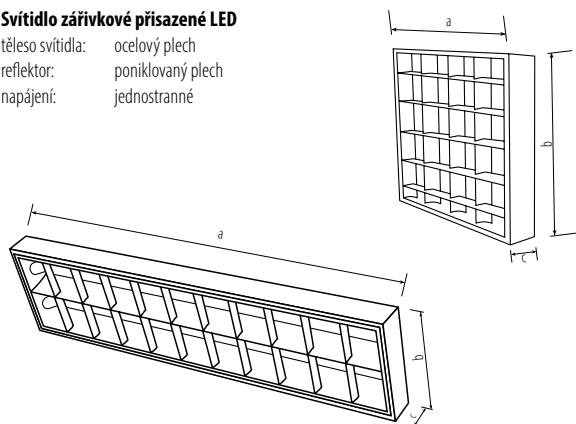

				a [mm]	b [mm]	c [mm]		DKC
ORI LED 4xT8/60cm	GXRP039	8592660108551	bílá	625	600	80	1370	526,- Kč
ORI LED 2xT8/120cm	GXRP040	8592660108650	bílá	1225	295	80	1195	526,- Kč

TAU LED

NEW LED

Svítilno zářivkové vestavné LED

těleso svítidla: ocelový plech
reflektor: poniklovaný plech
napájení: jednostranné

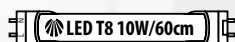
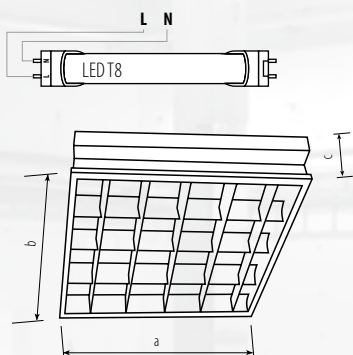

				a [mm]	b [mm]	c [mm]		DKC
TAU LED 4xT8/60cm	GXR038	8592660108568	bílá	616	616	80	1035	526,- Kč

GEMINI

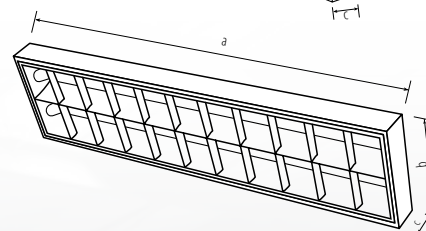
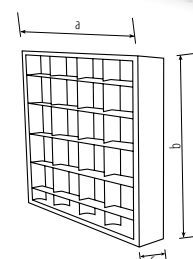
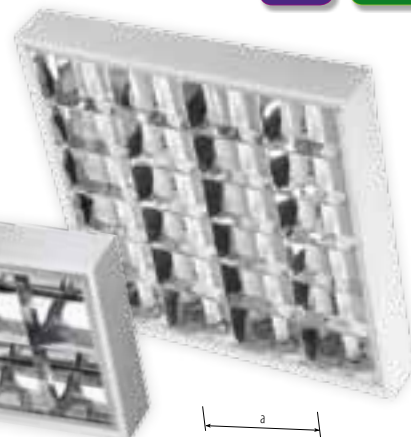
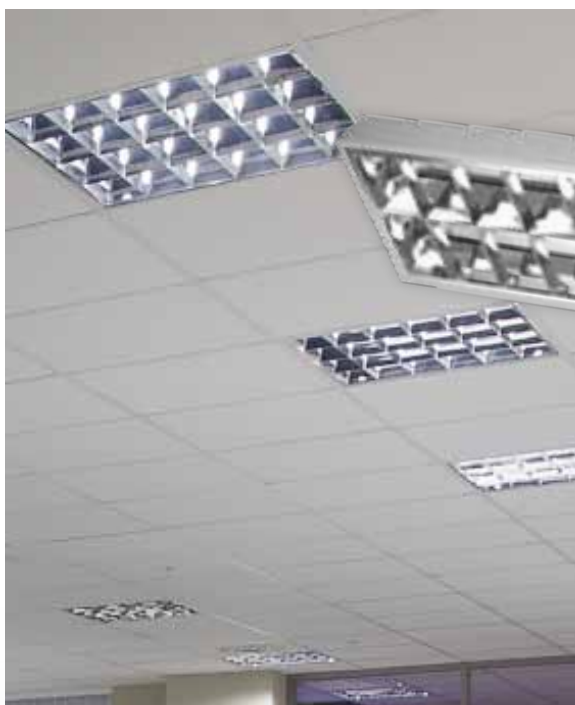

Svítlidlo zářivkové přisazené

těleso svítidla: ocelový plech
reflektor: elektrochemicky leštěný hliník
předřadník: elektronický (EVG)

Verze s nouzovým modulem

- osvětlení s nouzovým modulem a baterií
- LED indikace nouzového modulu
- funkční při havárii sítě
- vybaveno testovacím tlačítkem



						a [mm]	b [mm]	c [mm]		DKC
GEMINI EVG EB 4x18W	GXRPO09	8592660106243	bílá	4x18	615	600	75	2370	989,- Kč	
GEMINI EVG EB 1x36W	GXRPO41	8592660108933	bílá	1x36	1220	185	75	1900	1175,- Kč	
GEMINI EVG EB 2x36W	GXRPO10	8592660106250	bílá	2x36	1220	300	75	2195	961,- Kč	
GEMINI EVG EB 2x58W	GXRPO11	8592660106267	bílá	2x58	1520	300	75	2940	1215,- Kč	

					a [mm]	b [mm]	c [mm]		DKC
GEMINI EVG 4x18W	GXRPO01	8592660100791	bílá	4x18	615	600	75	2370	899,- Kč
GEMINI EVG 2x36W	GXRPO02	8592660100807	bílá	2x36	1220	300	75	2195	839,- Kč
GEMINI EVG 2x58W	GXRPO45	8592660109961	bílá	2x58	1520	300	75	2480	1099,- Kč

								a [mm]	b [mm]	c [mm]		DKC
GEMINI EVG EB 4x18W emergency	GXRPO46	8592660110035	4x18	EVG	1500	1:19	615	600	75	3450	1900,- Kč	
GEMINI EVG EB 2x36W emergency	GXRPO44	8592660110004	2x36	EVG	1500	1:19	1220	300	75	3600	1894,- Kč	
GEMINI EVG EB 2x58W emergency	GXRPO42	8592660110028	2x58	EVG	1800	1:20	1520	300	75	2980	2112,- Kč	

								a [mm]	b [mm]	c [mm]		DKC
GEMINI EVG 4x18W emergency	GXRPO13	8592660107820	4x18	EVG	1500	1:19	615	600	75	3450	2009,- Kč	
GEMINI EVG 2x36W emergency	GXRPO12	8592660107813	2x36	EVG	1500	1:19	1220	300	75	3600	2099,- Kč	
GEMINI EVG 2x58W emergency	GXRPO20	8592660110011	2x58	EVG	1800	1:20	1520	300	75	2980	2445,- Kč	

ARIES



Svítlidlo zářivkové vestavné

těleso svítidla: ocelový plech
 reflektor: hliník
 předradník: elektronický (EVG)

Verze s nouzovým modulem

- osvětlení s nouzovým modulem a baterií
- LED indikace nouzového modulu
- funkční při havárii sítě
- vybaveno testovacím tlačítkem

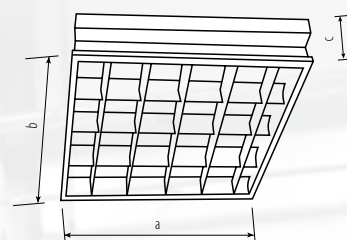

Logo	Model	EAN	Color	Lamp	Power	a [mm]	b [mm]	c [mm]	Weight [g]	Price	
	ARIES EVG EB 4x18W	GXR V017	8592660106274	bílá	4x18	595	595	75	2035	961,- Kč	
	ARIES EVG 4x18W	GXR V001	8592660100784	bílá	4x18	595	595	75	2100	799,- Kč	
	ARIES EVG EB 4x18W emergency	GXR V020	8592660110042	4x18	1500	1:19	595	595	75	2600	2292,- Kč
	ARIES EVG 4x18W emergency	GXR V016	8592660107905	4x18	1500	1:19	595	595	75	2600	1936,- Kč

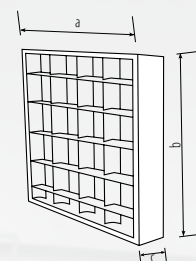
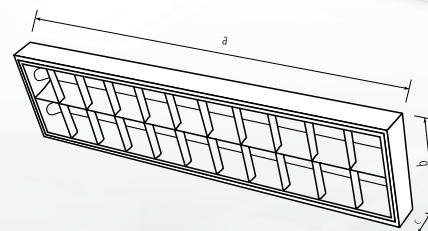
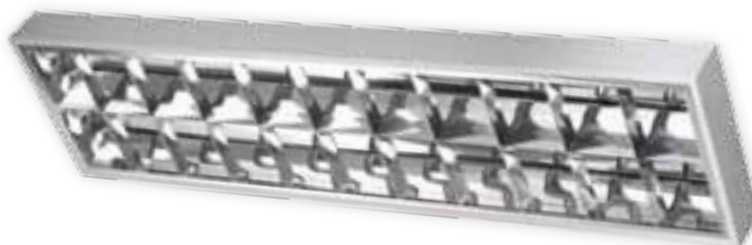

Svítlidlo zářivkové přisazené

těleso svítidla: ocelový plech
 reflektor: poniklovaný plech
 předradník: elektronický (EVG), indukční (VVG)

Verze s nouzovým modulem

- osvětlení s nouzovým modulem a baterií
- LED indikace nouzového modulu
- funkční při havárii sítě
- vybaveno testovacím tlačítkem



						a [mm]	b [mm]	c [mm]		DKC
ORI EVG 2x36W	GXRP008	8592660104782	bílá	2x36	EVG	1220	300	75	2195	720,- Kč
ORI EVG 4x18W	GXRP007	8592660104799	bílá	4x18	EVG	615	600	75	2370	720,- Kč
ORI VVG 2x36W	GXRP004	8592660102788	bílá	2x36	VVG	1220	300	75	2695	620,- Kč
ORI VVG 4x18W	GXRP003	8592660102771	bílá	4x18	VVG	615	600	75	2870	620,- Kč

								a [mm]	b [mm]	c [mm]		DKC
ORI EVG 2x36W emergency	GXRP019	8592660107882	bílá	2x36	EVG	1800	1:20	1220	300	75	2695	1756,- Kč
ORI EVG 4x18W emergency	GXRP018	8592660107875	bílá	4x18	EVG	1500	1:19	615	600	75	2870	1756,- Kč
ORI VVG 2x36W emergency	GXRP015	8592660107844	bílá	2x36	VVG	1800	1:20	1220	300	75	3195	1798,- Kč
ORI VVG 4x18W emergency	GXRP014	8592660107837	bílá	4x18	VVG	1500	1:19	615	600	75	3370	1798,- Kč



TAU

Svítilno zářivkové vestavné

těleso svítidla: ocelový plech
reflektor: poniklovaný plech
předřadník: elektronický (EVG), indukční (VVG)

Verze s nouzovým modulem

- osvětlení s nouzovým modulem a baterií
- LED indikace nouzového modulu
- funkční při havárii sítě
- vybaveno testovacím tlačítkem

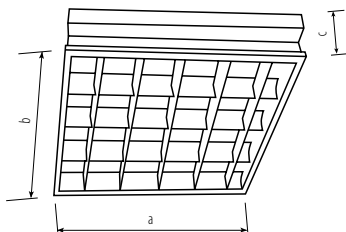

						a [mm]	b [mm]	c [mm]		DKC		
TAU EVG 4x18W	GXR009	8592660104775	bílá	4x18	EVG	595	595	75	2100	690,- Kč		
TAU VVG 4x18W	GXR002	8592660102764	bílá	4x18	VVG	595	595	75	2600	590,- Kč		
								a [mm]	b [mm]	c [mm]		DKC
TAU EVG 4x18W emergency	GXR019	8592660107929	bílá	4x18	EVG	1500	1:19	595	595	75	2600	1726,- Kč
TAU VVG 4x18W emergency	GXR015	8592660107899	bílá	4x18	VVG	1500	1:19	595	595	75	3100	1486,- Kč

Příslušenství

			DKC
Difuzor - DUST PC 1x18W	GXOS018	8592660102566	69,- Kč
Difuzor - DUST PC 1x36W	GXOS020	8592660102580	129,- Kč
Difuzor - DUST PC 1x58W	GXOS022	8592660102603	169,- Kč
Difuzor - DUST PC 2x18W	GXOS019	8592660102573	94,- Kč
Difuzor - DUST PC 2x36W	GXOS021	8592660102597	156,- Kč
Difuzor - DUST PC 2x58W	GXOS023	8592660102610	219,- Kč
Difuzor - DUST PS 1x18W	GXOS024	8592660102627	49,- Kč
Difuzor - DUST PS 1x36W	GXOS026	8592660102641	81,- Kč
Difuzor - DUST PS 1x58W	GXOS028	8592660102665	99,- Kč
Difuzor - DUST PS 2x18W	GXOS025	8592660102634	59,- Kč
Difuzor - DUST PS 2x36W	GXOS027	8592660102658	99,- Kč
Difuzor - DUST PS 2x58W	GXOS029	8592660102672	139,- Kč
Difuzor - DUST metal 2x36W	GXOS014	8592660101545	239,- Kč
Difuzor - DUST metal 2x58W	GXOS084	8592660105956	335,- Kč
Průchodka - DUST EVG,VVG	GXOS034	8592660102726	9,- Kč
Průchodka - DUST metal 2x36W	GXOS013	8592660101538	56,- Kč
Průchodka - DUST metal 2x58W	GXOS086	8592660105970	56,- Kč

			DKC
Klip PC - DUST EVG,VVG	GXOS036	8592660102740	14,- Kč
Klip nerez - DUST EVG,VVG	GXOS037	8592660102757	16,- Kč
Klip nerez - DUST metal 2x36W	GXOS017	8592660101576	25,- Kč
Klip nerez - DUST metal 2x58W	GXOS085	8592660105963	25,- Kč
Patice - DUST EVG,VVG	GXOS035	8592660102733	9,- Kč
Patice - DUST metal	GXOS016	8592660101569	9,- Kč

MH3 RX7S

Metalhalogenidový reflektor

těleso svítidla: hliník
 reflektor: hliník
 ochranné sklo: tvrzené sklo
 - pracho a vodotěsný

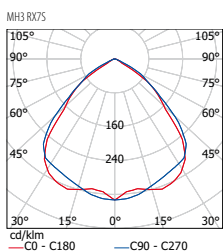
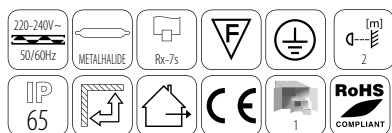
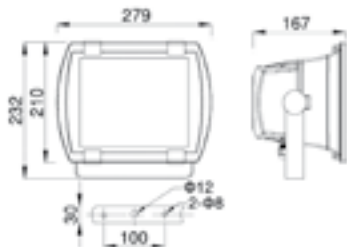

							DKC
MH3 RX7S 70W	GXMH011	8592660103594	černá	70	symetrický	3,50 kg	949,- Kč
MH3 RX7S 150W	GXMH012	8592660103679	černá	150	symetrický	4,40 kg	1099,- Kč

MH4 E40

Metalhalogenidový reflektor

těleso svítidla: hliník
 reflektor: hliník
 ochranné sklo: tvrzené sklo
 - pracho a vodotěsný

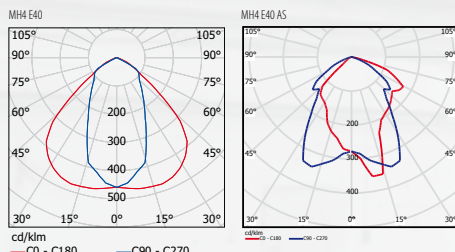
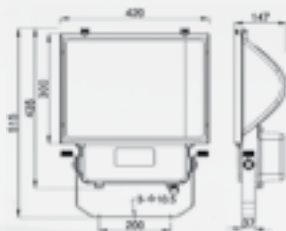

							DKC
MH4 E40 250W	GXMH001	8592660103556	černá	250	symetrický	6,50 kg	1429,- Kč
MH4 E40 400W	GXMH002	8592660103617	černá	400	symetrický	7,40 kg	1599,- Kč
MH4 E40 250W/AS	GXMH003	8592660103624	černá	250	asymetrický	6,50 kg	1270,- Kč
MH4 E40 400W/AS	GXMH004	8592660103631	černá	400	asymetrický	7,40 kg	1429,- Kč

MH5 E40

Metalhalogenidový reflektor

těleso svítidla: hliník
 reflektor: hliník
 ochranné sklo: tvrzené sklo
 - pracho a vodotěsný

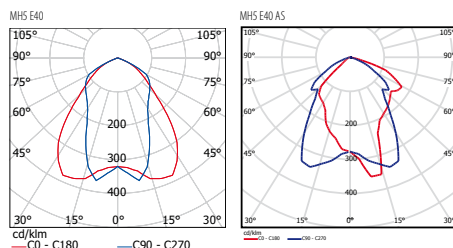

							DKC
MH5 E40 250W	GXMH005	8592660103563	■ černá	250	symetrický	8,10 kg	1489,- Kč
MH5 E40 400W	GXMH006	8592660103648	■ černá	400	symetrický	8,90 kg	1645,- Kč
MH5 E40 250W/AS	GXMH007	8592660103655	■ černá	250	asymetrický	8,10 kg	1485,- Kč
MH5 E40 400W/AS	GXMH008	8592660103662	■ černá	400	asymetrický	8,90 kg	1641,- Kč

MH6 RX7S

Metalhalogenidový reflektor

těleso svítidla: hliník
 reflektor: hliník
 ochranné sklo: tvrzené sklo
 - pracho a vodotěsný

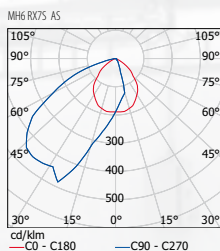
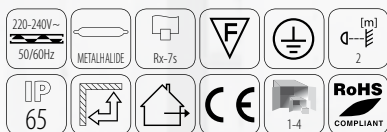

							DKC
MH6 RX7S 70W/AS	GXMH009	8592660103570	■ černá	70	asymetrický	3,00 kg	899,- Kč
MH6 RX7S 150W/AS	GXMH010	8592660103587	■ černá	150	asymetrický	4,50 kg	1099,- Kč

HALO 150



Halogenový reflektor

těleso svítidla: hliník
ochranné sklo: tvrzené sklo
- voděodolné

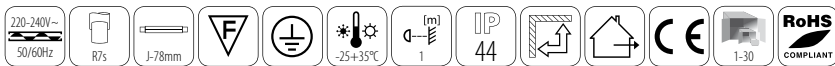
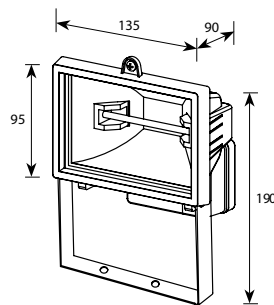

Model	Code	EAN	Color	Power [W]	Weight	Price
HALO 150 B	GXER008	8592660100944	černá	150	0,33 kg	99,- Kč
HALO 150 W	GXER009	8592660100968	bílá	150	0,33 kg	99,- Kč

HALO 500



Halogenový reflektor

těleso svítidla: hliník
ochranné sklo: tvrzené sklo
- voděodolné

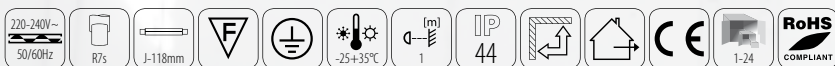
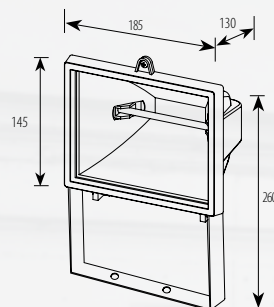

Model	Code	EAN	Color	Power [W]	Weight	Price
HALO 500 B	GXER010	8592660100975	černá	500	0,63 kg	129,- Kč
HALO 500 W	GXER011	8592660100982	bílá	500	0,63 kg	129,- Kč

TOMI 150

Halogenový reflektor s čidlem pohybu

těleso svítidla: hliník
ochranné sklo: tvrzené sklo
- voděodolné

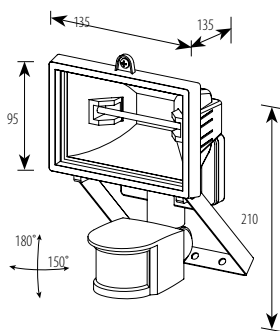
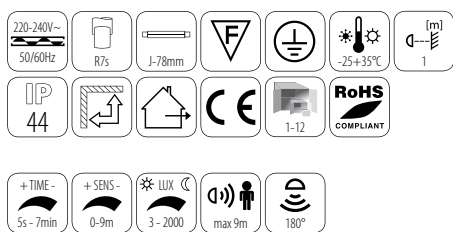

TOMI 150 B	GXER001	8592660100722	černá	150	0,52 kg		DKC
TOMI 150 W	GXER002	8592660100739	bílá	150	0,52 kg		DKC

TOMI 500

Halogenový reflektor s čidlem pohybu

těleso svítidla: hliník
ochranné sklo: tvrzené sklo
- voděodolné

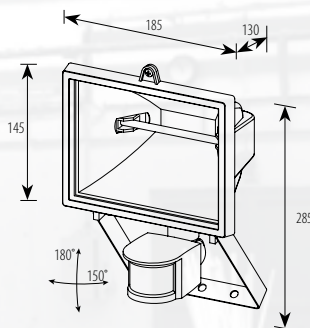
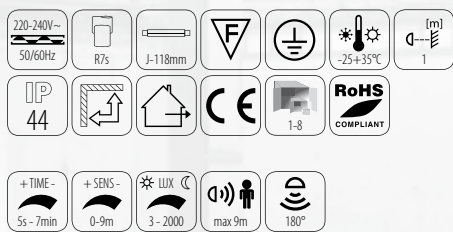

TOMI 500 B	GXER003	8592660100746	černá	500	0,82 kg		DKC
TOMI 500 W	GXER004	8592660100753	bílá	500	0,82 kg		DKC

ATTILA ROUND



Nájezdové svítidlo
 těleso svítidla: hliník
 prsten: nerezová ocel
 ochranné sklo: tvrzené sklo

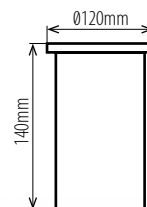

Attila round



GXNJ001



8592660109015



matný chrom

DKC

669,- Kč

ATTILA SQUARE



Nájezdové svítidlo
 těleso svítidla: hliník
 prsten: nerezová ocel
 ochranné sklo: tvrzené sklo

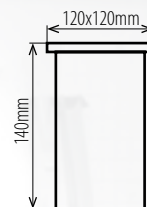

Attila square



GXNJ002



8592660109022



matný chrom

DKC

669,- Kč

PODHLADOVÁ BODOVÁ SVÍTIDLA







AXL 2114

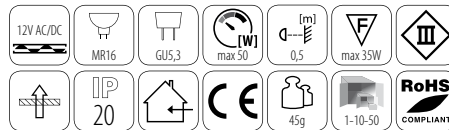
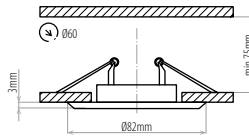

Podhledové svítidlo na MR16

- pevné
- kovový výlisek



	CODE				DKC
AXL 2114-W	2114	GXPP003	8592660101972	bílá	39,- Kč
AXL 2114-G	2114	GXPP004	8592660101989	zlatá	39,- Kč
AXL 2114-BRM	2114	GXPP006	8592660102009	matná mosaz	39,- Kč
AXL 2114-A	2114	GXPP007	8592660102016	antik	39,- Kč
AXL 2114-C	2114	GXPP008	8592660102023	chrom	39,- Kč
AXL 2114-CM	2114	GXPP009	8592660102030	matný chrom	39,- Kč
AXL 2114-GM	2114	GXPP010	8592660102047	černý chrom	39,- Kč

DUFF 204



Podhledové svítidlo na GU 10

- pevné
- kovový výlisek

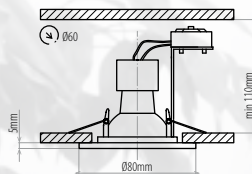

230V

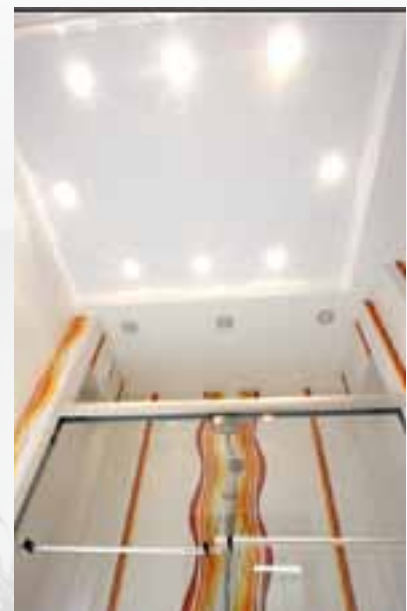

	CODE				DKC
DUFF 204-C	204	GXPP023	8592660102153	chrom	89,- Kč
DUFF 204-CM	204	GXPP024	8592660102160	matný chrom	89,- Kč

AXL 2115



Podhledové svítidlo na MR16

- výklopné
- kovový výlisek

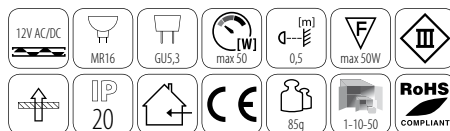
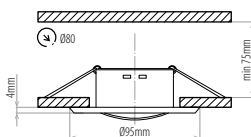

	CODE		EAN		DKC
AXL 2115-W	2115	GXPP030	8592660102207	bílá	58,- Kč
AXL 2115-G	2115	GXPP031	8592660102214	zlatá	58,- Kč
AXL 2115-BRM	2115	GXPP033	8592660102221	matná mosaz	58,- Kč
AXL 2115-A	2115	GXPP034	8592660102238	antik	58,- Kč
AXL 2115-C	2115	GXPP035	8592660102245	chrom	58,- Kč
AXL 2115-CM	2115	GXPP036	8592660102252	matný chrom	58,- Kč
AXL 2115-GM	2115	GXPP037	8592660102269	černý chrom	58,- Kč

DUFF 205



Podhledové svítidlo na GU 10

- výklopné
- kovový výlisek

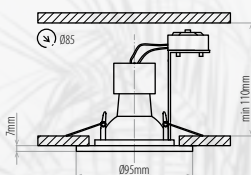

230V



	CODE		EAN		DKC
DUFF 205-C	205	GXPP050	8592660102382	chrom	99,- Kč
DUFF 205-CM	205	GXPP051	8592660102399	matný chrom	99,- Kč





AXL 2117

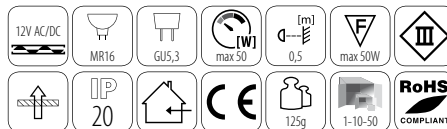
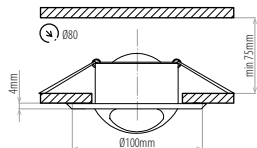

Podhledové svítidlo na MR16

- výklopné typu "rybí oko"
- kovový výlisek



	CODE				DKC
AXL 2117-BRM	2117	GXPP040	8592660102283	matná mosaz	85,- Kč
AXL 2117-C	2117	GXPP042	8592660102306	chrom	85,- Kč
AXL 2117-CM	2117	GXPP043	8592660102313	matný chrom	85,- Kč

ROLF IP54

NEW



Podhledové svítidlo na MR16

- pevné
- odlitek z hliníkové slitiny
- vyšší stupeň krytí IP54
- vhodný do koupelen

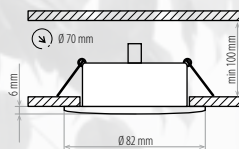

	CODE				DKC
ROLF IP54-CM	DS83	GXPK001	8592660109367	matný chrom	210,- Kč

AXL 5514



Podhledové svítidlo na MR16

- pevné
- odlitek z hliníkové slitiny

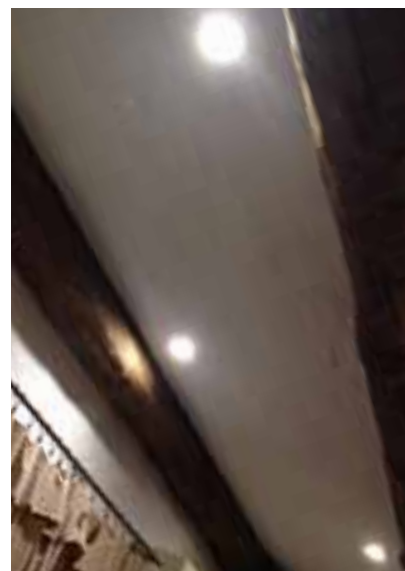
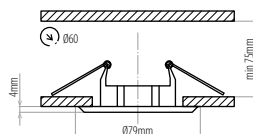

	CODE		EAN		DKC
AXL 5514-PCM/N	5514	GXPLO16	8592660101743	perletové matný chrom/ nikl	75,- Kč
AXL 5514-PG/N	5514	GXPLO17	8592660101750	perletově zlatá/nikl	75,- Kč
AXL 5514-SN/G	5514	GXPLO18	8592660101767	saténový nikl/zlatá	75,- Kč
AXL 5514-SN/N	5514	GXPLO19	8592660101774	saténový nikl/nikl	75,- Kč
AXL 5514-SG/N	5514	GXPLO20	8592660101781	saténové zlato/nikl	75,- Kč



AXL 5514

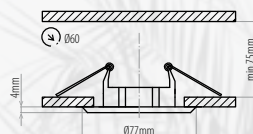

Podhledové svítidlo na MR16

- pevné
- odlitek z hliníkové slitiny



	CODE		EAN		DKC
AXL 5514-W	5514	GXPLO01	8592660101637	bílá	49,- Kč
AXL 5514-A	5514	GXPLO03	8592660101644	antik	49,- Kč
AXL 5514-C	5514	GXPLO04	8592660101651	chrom	49,- Kč
AXL 5514-CM	5514	GXPLO05	8592660101668	matný chrom	49,- Kč

AXL DS050

Podhledové svítidlo na MR16

- pevné
- odlitek z hliníkové slitiny

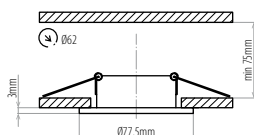

AL



AXL DS050-AL

CODE

DS050



GXPA001



8592660101583



hliník

DKC

109,- Kč

DIO DS02B

Podhledové svítidlo na MR16

- pevné
- odlitek z hliníkové slitiny

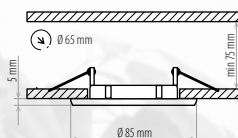

W

CM

C

AB



DIO DS02B-W

CODE

DS02B



GXPL055



8592660104928



bílá

DKC

50,- Kč

DIO DS02B-CM

DS02B

GXPL050

8592660104874

matný chrom

50,- Kč

DIO DS02B-C

DS02B

GXPL051

8592660104881

chrom

50,- Kč

DIO DS02B-AB

DS02B

GXPL049

8592660104867

matná mosaz

50,- Kč



IZZY DS10

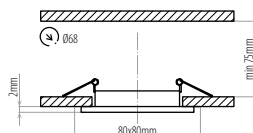

Podhledové svítidlo na MR16

- pevné čtvercové
- odlitek z hliníkové slitiny



	CODE		EAN		DKC
IZZY DS10-AB	DS10	GXPL009	8592660101675	broušená mosaz	69,- Kč
IZZY DS10-C	DS10	GXPL010	8592660101682	chrom	69,- Kč
IZZY DS10-SN	DS10	GXPL011	8592660101699	saténový nikel	69,- Kč

IZZY DSL50



Podhledové svítidlo na MR16

- pevné
- odlitek z hliníkové slitiny

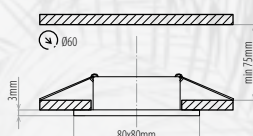

	CODE		EAN		DKC
IZZY DSL50-AL	DSL50	GXPA002	8592660101590	hliník	109,- Kč





OZZY 2116C

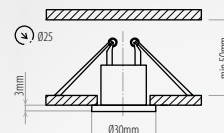

Podhledové svítidlo na JC

- typu "hvězdné nebe"
- odlietek z hliníkové slitiny



	CODE				DKC
OZZY 2116C-W	2116C	GXPL012	8592660101705	bílá	41,- Kč
OZZY 2116C-G	2116C	GXPL013	8592660101712	zlatá	41,- Kč
OZZY 2116C-C	2116C	GXPL014	8592660101729	chrom	41,- Kč
OZZY 2116C-CM	2116C	GXPL015	8592660101736	matný chrom	41,- Kč





NEW

PEARL

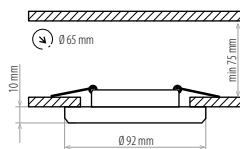

Podhledové svítidlo na MR16
- pevné



	CODE				DKC
GLASS PEARL	DSL50	GXP0002	8592660109091	černá	142,- Kč
BLACK PEARL	DSL50	GXP0001	8592660109084	zrcadlové sklo	142,- Kč

AXL DT050



Podhledové svítidlo na MR16
- výklopné
- odlitek z hliníkové slitiny

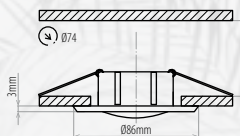

	CODE				DKC
AXL DT050-AL	DT050	GXPA003	8592660101606	hliník	139,- Kč



AXL 5515

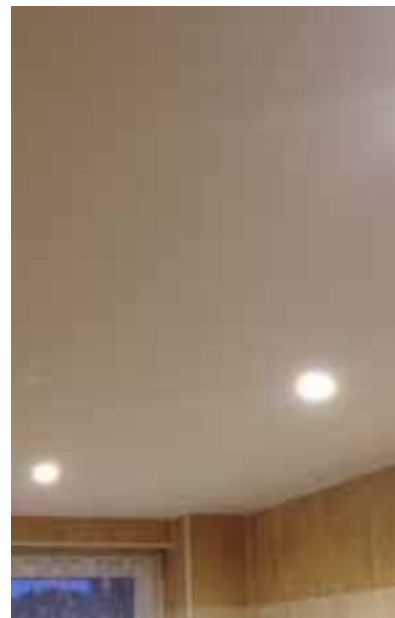
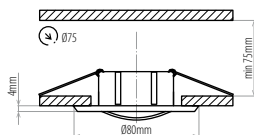

Podhledové svítidlo na MR16

- výklopné
- odlietek z hliníkové slitiny



	CODE		EAN		DKC
AXL 5515-W	5515	GXPL024	8592660101828	bílá	72,- Kč
AXL 5515-A	5515	GXPL026	8592660101835	antik	72,- Kč
AXL 5515-C	5515	GXPL028	8592660101842	chrom	72,- Kč
AXL 5515-CM	5515	GXPL029	8592660101859	matný chrom	72,- Kč

AXL 5515



Podhledové svítidlo na MR16

- výklopné
- odlietek z hliníkové slitiny

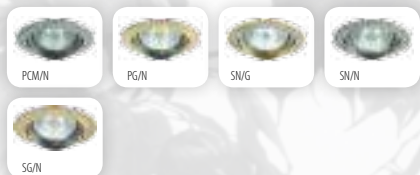
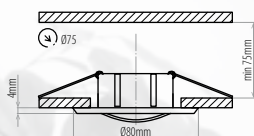

	CODE		EAN		DKC
AXL 5515-PCM/N	5515	GXPL041	8592660101910	perletově matný chrom/ nikl	99,- Kč
AXL 5515-PG/N	5515	GXPL042	8592660101927	perletově zlatá/nikl	99,- Kč
AXL 5515-SN/G	5515	GXPL043	8592660101934	saténový nikl/zlatá	99,- Kč
AXL 5515-SN/N	5515	GXPL044	8592660101941	saténový nikl/nikl	99,- Kč
AXL 5515-SG/N	5515	GXPL045	8592660101958	saténové zlato/nikl	99,- Kč

SLASH 5519



Podhledové svítidlo na MR11

- výklopné
- odlitek z hliníkové slitiny

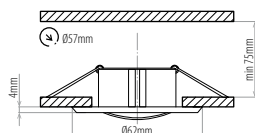

	CODE		EAN		DKC
SLASH 5519-C	5519	GXPLO48	8592660109817	chrom	69,- Kč
SLASH 5519-CM	5519	GXPLO23	8592660101811	matný chrom	69,- Kč
SLASH 5519-PCM/N	5519	GXPLO36	8592660101897	perletove matný chrom/nikl	79,- Kč
SLASH 5519-SN/N	5519	GXPLO40	8592660101903	satenovy nikl/nickel	79,- Kč

DIO DT02B



Podhledové svítidlo na MR16

- výklopné
- odlitek z hliníkové slitiny

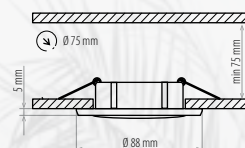

	CODE		EAN		DKC
DIO DT02B-W	DT02B	GXPLO56	8592660104935	bílá	59,- Kč
DIO DT02B-CM	DT02B	GXPLO53	8592660104904	matný chrom	59,- Kč
DIO DT02B-C	DT02B	GXPLO54	8592660104911	chrom	59,- Kč
DIO DT02B-AB	DT02B	GXPLO52	8592660104898	matná mosaz	59,- Kč





IZZY DT10

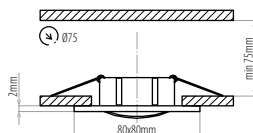

Podhledové svítidlo na MR16

- výklonný čtverec
- odlitek z hliníkové slitiny



	CODE				DKC
IZZY DT10-AB	DT10	GXPL033	8592660101866	broušená mosaz	99,- Kč
IZZY DT10-C	DT10	GXPL034	8592660101873	chrom	99,- Kč
IZZY DT10-CM	DT10	GXPL035	8592660101880	saténový nikel	99,- Kč

IZZY DTL50



Podhledové svítidlo na MR16

- výklonné
- odlitek z hliníkové slitiny

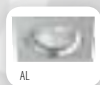
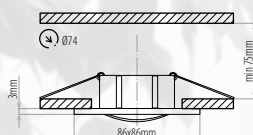

	CODE				DKC
IZZY DTL50-AL	DTL50	GXPA004	8592660101613	hliník	139,- Kč

NOVA

NEW



Podhledové svítidlo na MR16

- výklopné
- odlitek z hliníkové slitiny

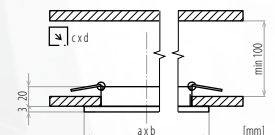





	CODE					a [mm]	b [mm]	c [mm]	d [mm]		DKC
NOVA 50 - AL	DTL50	GXP0003	8592660109046	1 x max 50W	hliník	92	92	75	75	115	155,- Kč
NOVA 250 - AL	DTL250	GXP0004	8592660109053	2 x max 50W	hliník	92	171	75	155	230	269,- Kč
NOVA 350 - AL	DTL350	GXP0005	8592660109060	3 x max 50W	hliník	92	250	75	230	345	448,- Kč
NOVA 450 - AL	DTL450	GXP0006	8592660109077	4 x max 50W	hliník	171	171	155	155	460	599,- Kč

OZZY 2116B

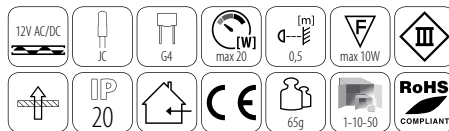
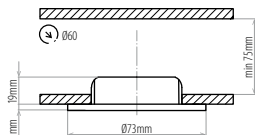

Podhledové svítidlo na JC

- nábytkové
- kovový výlisek/sklo



	CODE				DKC
OZZY 2116B-BRM	2116B	GXPP018	8592660102115	matná mosaz	69,- Kč
OZZY 2116B-C	2116B	GXPP020	8592660102139	chrom	69,- Kč
OZZY 2116B-CM	2116B	GXPP021	8592660102146	matný chrom	69,- Kč

Příslušenství

			popis	DKC
LH-GZ10	GXOS043	8592660103297	Keramická objímka 220-240V GZ10	9,- Kč
LH-GX5,3	GXOS045	8592660103310	Keramická objímka 12V GX5,3	6,- Kč
TRAFO ET20	GXOS053	8592660103457	Elektronický transformátor 10-20W	127,- Kč
TRAFO ET60	GXOS054	8592660103518	Elektronický transformátor 20-60W	169,- Kč
TRAFO ET105	GXOS055	8592660103501	Elektronický transformátor 35-110W	189,- Kč
TRAFO ET150	GXOS056	8592660103495	Elektronický transformátor 50-150W	329,- Kč
TRAFO ET210	GXOS057	8592660103488	Elektronický transformátor 50-210W	389,- Kč
DRIVER 15W	GXLD003	8592660105185	Elektronický transformátor 15W	259,- Kč
DRIVER 25W	GXLD014	8592660109435	Elektronický transformátor 25W	750,- Kč
DRIVER 40W	GXLD004	8592660105192	Elektronický transformátor 40W	399,- Kč
DRIVER 75W	GXLD005	8592660105208	Elektronický transformátor 75W	509,- Kč
DRIVER 100W	GXLD006	8592660105215	Elektronický transformátor 100W	599,- Kč
DRIVER 150W	GXLD007	8592660105222	Elektronický transformátor 150W	649,- Kč
DRIVER 200W	GXLD015	8592660109442	Elektronický transformátor 200W	955,- Kč
DRIVER LED IP67 30W	GXLD008	8592660105239	Elektronický transformátor LED 30W	499,- Kč
DRIVER LED IP67 100W	GXLD009	8592660105246	Elektronický transformátor LED 100W	1279,- Kč
DRIVER LED IP67 150W	GXLD010	8592660105253	Elektronický transformátor LED 150W	1909,- Kč

SVĚTELNÉ ZDROJE

JDR



Halogenová žárovka
- reflektor typu "ALU"

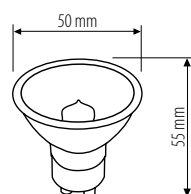

						DKC
JDR 25W 60	GXZH018	8592660101156	25	60	180	39,- Kč
JDR 35W 60	GXZH019	8592660101255	35	60	300	39,- Kč
JDR 50W 60	GXZH020	8592660101262	50	60	430	39,- Kč

JCDR



Halogenová žárovka
- speciální projektorová žárovka

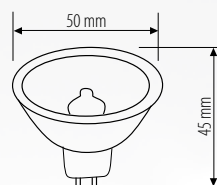

						DKC
JCDR 25W 38	GXZH021	8592660101163	25	38	180	*
JCDR 35W 38	GXZH022	8592660101279	35	38	300	*
JCDR 50W 38	GXZH023	8592660101286	50	38	430	*

* zboží dostupné jen v Polsku

J78, 118, 189, 254

Halogenová žárovka

- projektorová

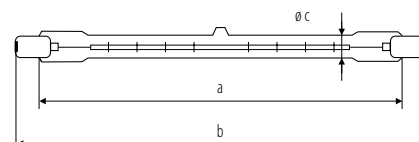

					a [mm]	b [mm]	c [mm]		DKC
J78 60W	GXZH001	8592660101064	60	800	74	78	8	6g	17,- Kč
J78 100W	GXZH002	8592660101071	100	1200	74	78	8	6g	17,- Kč
J78 150W	GXZH003	8592660101088	150	2000	74	78	8	6g	17,- Kč
J118 100W	GXZH004	8592660101040	100	1200	114	118	8	8g	17,- Kč
J118 150W	GXZH005	8592660101095	150	2000	114	118	8	8g	17,- Kč
J118 200W	GXZH006	8592660101101	200	2800	114	118	8	8g	17,- Kč
J118 300W	GXZH007	8592660101118	300	4500	114	118	8	8g	17,- Kč
J118 500W	GXZH008	8592660101125	500	8000	114	118	8	8g	17,- Kč
J189 1000W	GXZH009	8592660101057	1000	20000	185	189	9	15g	37,- Kč
J254 1500W	GXZH010	8592660101033	1500	30000	250	254	10	20g	38,- Kč

G9 C



Halogenová žárovka

- efektivní třída C

- více než 25% nižší spotřeba energie ve srovnání s žárkami G9 třídy E

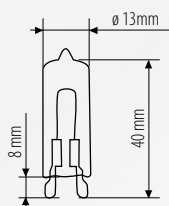

					DKC
G9 C 18W	GXZH042	8592660105918	18	210	19,- Kč
G9 C 28W	GXZH043	8592660105925	28	370	19,- Kč
G9 C 42W	GXZH044	8592660105932	42	630	19,- Kč
G9 C 52W	GXZH045	8592660105949	52	820	19,- Kč

MR16



Halogenová žárovka
- reflektorová

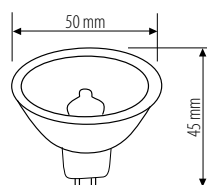

						DKC
MR16 20W 60	GXZH014	8592660101217	20	60	230	14,- Kč
MR16 35W 60	GXZH016	8592660101231	35	60	680	14,- Kč
MR16 50W 60	GXZH017	8592660101248	50	60	870	14,- Kč

MR11



Halogenová žárovka
- reflektorová

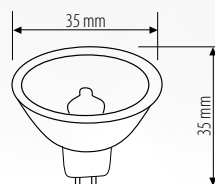





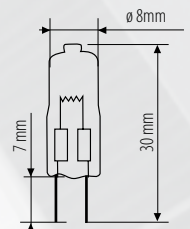

						DKC
MR11 20W 30	GXZH011	8592660101132	20	30	400	14,- Kč
MR11 35W 30	GXZH012	8592660101200	35	30	630	14,- Kč

JC G4



Halogenová žárovka



					DKC
JC 5W G4	GXZH027	8592660101187	5	35	11,- Kč
JC 10W G4	GXZH028	8592660101316	10	100	11,- Kč
JC 20W G4	GXZH029	8592660101323	20	260	11,- Kč
JC 35W G4	GXZH030	8592660101330	35	540	11,- Kč

MHQ-RX7S



Metalhalogenidová výbojka

- horizontální poloha $\pm 45^\circ$
- vhodné pro reflektory RX-7 série: MH3, MH6

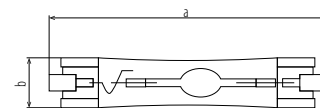
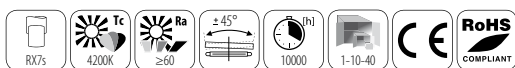

					a [mm]	b [mm]		DKC
MHQ-RX7S 70W/4200K	GXVV001	8592660105451	70W/0,98A	5600	118	20	20 g	299,- Kč
MHQ-RX7S 150W/4200K	GXVV002	8592660105451	150W/1,80A	13500	137	22	26 g	299,- Kč

MHQ-E40



Metalhalogenidová výbojka

- univerzální provozní poloha
- vhodné pro reflektory řady: MH4, MH5

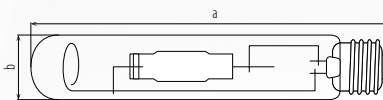
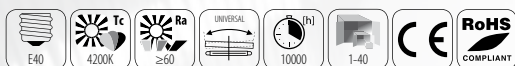

					a [mm]	b [mm]		DKC
MHQ-E40 250W/4200K	GXVV003	8592660105444	250W/2,15A	19000	240	46	156 g	349,- Kč
MHQ-E40 400W/4200K	GXVV004	8592660105413	400W/3,25A	28000	280	62	178 g	369,- Kč

MINI E14



Kompaktní zářivka

Životnost:
Třída energetické účinnosti (EEI):

8.000 hodin
A

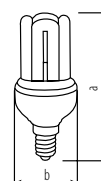

					a [mm]	b [mm]		DKC
MINI 4U 9W E14	GXZK007	8592660100234	9	425	100	48	45 g	79,- Kč
MINI 4U 11W E14	GXZK008	8592660100241	11	545	105	48	50 g	79,- Kč
MINI 4U 15W E14	GXZK009	8592660100258	15	800	113	48	60 g	79,- Kč

MINI E27



Kompaktní zářivka

Životnost:
Třída energetické účinnosti (EEI):

8.000 hodin
A

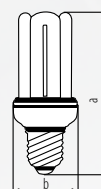

					a [mm]	b [mm]		DKC
MINI 4U 9W E27	GXZK010	8592660100265	9	425	100	48	45 g	99,- Kč
MINI 4U 11W E27	GXZK011	8592660100272	11	545	105	48	50 g	99,- Kč
MINI 4U 13W E27	GXZK012	8592660100289	13	665	111	48	55 g	99,- Kč
MINI 4U 15W E27	GXZK013	8592660100296	15	800	113	48	60 g	99,- Kč
MINI 4U 20W E27	GXZK014	8592660100302	20	1200	135	48	95 g	99,- Kč
MINI 4U 23W E27	GXZK015	8592660100319	23	1380	150	48	100 g	99,- Kč

SPIRE E14



Kompaktní zářivka

Životnost:

8.000 hodin

Třída energetické účinnosti (EEI):

A

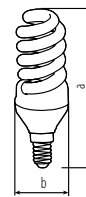

					a [mm]	b [mm]		DKC
SPIRE 7W E14	GXZK024	8592660100401	7	350	91	40	25 g	99,- Kč
SPIRE 9W E14	GXZK025	8592660100418	9	440	95	40	35 g	99,- Kč
SPIRE 11W E14	GXZK028	8592660100654	11	550	100	40	35 g	99,- Kč

SPIRE E27



Kompaktní zářivka

Životnost:

8.000 hodin

Třída energetické účinnosti (EEI):

A



						a [mm]	b [mm]		DKC
SPIRE 9W E27	GXZK026	8592660100425	9	2700K	440	95	40	30 g	99,- Kč
SPIRE 11W E27	GXZK027	8592660100432	11	2700K	550	100	40	35 g	99,- Kč
SPIRE 15W E27	GXZK029	8592660100647	15	2700K	800	116	40	50 g	109,- Kč
SPIRE 20W E27	GXZK030	8592660100630	20	2700K	1152	116	50	70 g	109,- Kč
SPIRE 25W E27 - CW	GXZK066	8592660104751	25	6400K	1595	156	60	90 g	109,- Kč
SPIRE 25W E27 - WW	GXZK065	8592660104768	25	2700K	1595	156	60	90 g	109,- Kč

KANCELÁŘSKÁ SVÍTIDLA A SVÍTIDLA PRO DOMÁCNOST



VELA HF E27



Svítilno s mikrovlnným židlom

těleso svítidla: polypropylen (PP)
difúzor: sklo

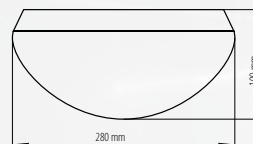
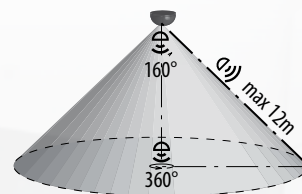

VELA HF E27



GXIZ016



8592660104652



bílá

DKC

899,- Kč

MANA 2E27

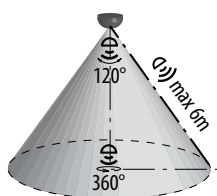

Svítlidlo s čidlom pohybu

těleso svítidla: kov
difuzor: sklo

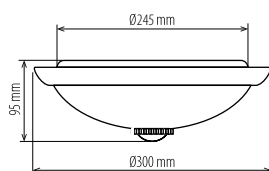

MANA 2E27



GXIZ017



8592660104669



bílá



360



120

DKC

369,- Kč

MANA II 2E27

NEW

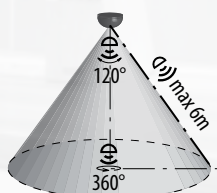

Svítlidlo s čidlom pohybu

těleso svítidla: kov
difuzor: sklo

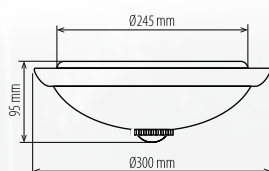

MANA II 2E27



GXIZ021



8592660109039



bílá



360



120

DKC

399,- Kč

ARA E27



Svítilno zářivkové přisazené

těleso svítidla: polykarbonát
 difuzor: polykarbonát
 - pracho a vodotěsné
 - vhodné pro venkovní použití.
 - vhodné pro použití do koupelen.

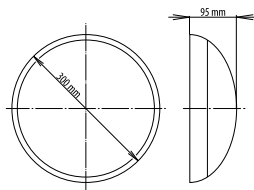

ARA E27



GXI2015



8592660104409



bílá



75



1090g

DKC

319,- Kč

ARAX E27



Svítilno zářivkové přisazené

těleso svítidla: polykarbonát
 difuzor: polykarbonát
 - pracho a vodotěsné
 - vhodné pro venkovní použití.
 - vhodné pro použití do koupelen.

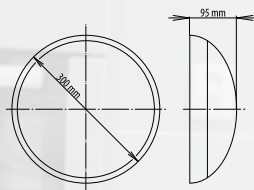

ARAX E27



GXI2090



8592660108322



bílá



75



1090g

DKC

319,- Kč

TAURUS 1E27

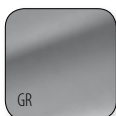

Svítlidlo zářivkové přisazené

těleso svítidla: polykarbonát

difuzor: polykarbonát

- pracho a vodotěsné
- vhodné pro venkovní použití.
- vhodné pro použití do koupelen.

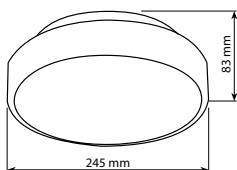

TAURUS 1E27 GR



GXIZ001



8592660100036



Sedá

DKC

350,- Kč

TAURUS 2E27



Svítlidlo zářivkové přisazené

těleso svítidla: polykarbonát

difuzor: polykarbonát

- pracho a vodotěsné
- vhodné pro venkovní použití.
- vhodné pro použití do koupelen.

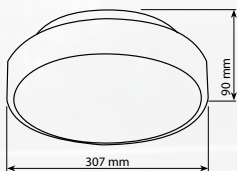

TAURUS 2E27 GR



GXIZ004



8592660100128



Sedá

DKC

430,- Kč

PERSEUS 1E27

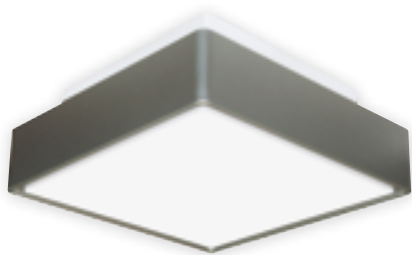

Svitídko zářivkové přisazené

těleso svítidla: polykarbonát
 difuzor: polykarbonát
 - pracho a vodotěsné
 - vhodné pro venkovní použití.
 - vhodné pro použití do koupelen.

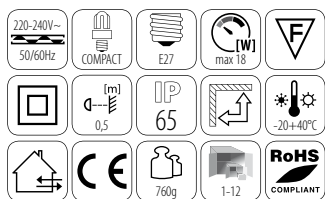
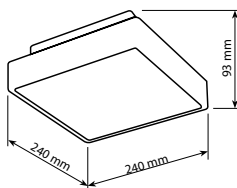

PERSEUS 1E27 GR



GXIZ007



8592660100142



šedá

DKC

386,- Kč

PERSEUS 2E27



Svitídko zářivkové přisazené

těleso svítidla: polykarbonát
 difuzor: polykarbonát
 - pracho a vodotěsné
 - vhodné pro venkovní použití.
 - vhodné pro použití do koupelen.

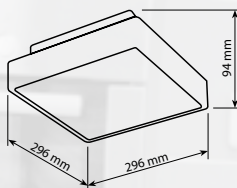

PERSEUS 2E27 GR



GXIZ010



8592660100173



šedá

DKC

470,- Kč

PERSEUS 2E27 W

GXIZ011

8592660100180

bílá

458,- Kč

CETUS 2E27



Svítlidlo zářivkové přisazené

těleso svítidla: polykarbonát
 difuzor: polykarbonát
 - pracho a vodotěsné
 - vhodné pro venkovní použití.
 - vhodné pro použití do koupelen.

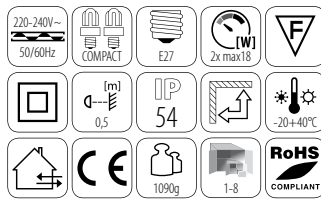
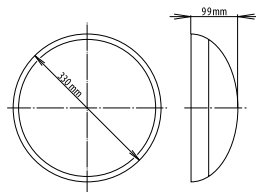

CETUS 2E27 GR

CETUS 2E27 W



GXIZ013

GXIZ014



8592660100203

8592660100210



šedá

bilá

DKC

410,- Kč

378,- Kč

CALIPSO

Dekoratívni nástenné / stropné svietidlo

- difúzor: dekoratívni sklo
 těleso: ocelový plech
 úchyty: galvanizovaný hliník
- lisovaný difúzor zdobený potiskem a pískovaním poskytuje rovnomerný rozptyl svetla
 - dekoratívni hliníkové galvanizované úchyty ladí s jednoduchým tvarem difúzoru

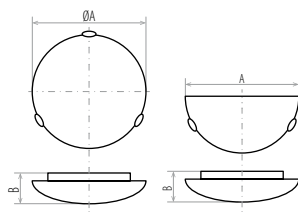

						a ^[mm]	b ^[mm]		DKC
1030 1/2 Y CALIPSO-W	GXIZ030	8592660107141	1x max 60	1x E27	bílá	300	90	500	324,- Kč
1030 1/2 Y CALIPSO-AM	GXIZ031	8592660107158	1x max 60	1x E27	ambra	300	90	500	324,- Kč
1030 MY CALIPSO-W	GXIZ032	8592660107165	1x max 60	1x E27	bílá	300	80	1000	374,- Kč
1030 MY CALIPSO-AM	GXIZ033	8592660107172	1x max 60	1x E27	ambra	300	80	1000	374,- Kč
1130 SY CALIPSO-W	GXIZ034	8592660107189	2x max 60	2x E27	bílá	400	95	1500	582,- Kč
1130 SY CALIPSO-AM	GXIZ035	8592660107196	2x max 60	2x E27	ambra	400	95	1500	582,- Kč
1230 DY CALIPSO-W	GXIZ036	8592660107202	3x max 40	3x E27	bílá	500	110	1900	1098,- Kč
1230 DY CALIPSO-AM	GXIZ037	8592660107219	3x max 40	3x E27	ambra	500	110	1900	1098,- Kč



Úchyty

Dekoratívni úchyty korespondujú s jednoduchým tvarem difúzoru. Jsou vyrobeny z galvanizovaného tlakově litého hliníku. Na rozdíl úchyť z plastu, které se používají u levných náhražek, se nedeformují a zajišťují tak bezpečné a stabilní připevnění difúzoru k montuře.



Objímky

Všechny typy jsou osazeny keramickými objímkami. Oproti plastovým náhražkám nežloutnou, nekřehnou a netaví se při vyšších teplotách.



Připojení k napájení

Svítidla obsahují svorkovnici pro připojení k napájení. Verze s více světelnými zdroji jsou navíc vybaveny kabeláží. Montáž a připojení nejsou díky tomu obtížné a ani náročné na čas. Celá instalace je tedy rychlá a snadná.



Balení

Každý kus je zabalen ve vlastní krabici. Difúzor je chráněn v bublinkové folii. Takovýto způsob balení chrání výrobek před náhodným poškozením například při přepravě.



Difúzor

Difúzor je vyroben z lisovaného odolného skla. Jeho struktura zaručuje rovnomerné rozptýlení svetla. Z vnitřní strany je difúzor zdoben potiskem, z vnější potom upraven pískováním. Kvalitní provedení, tloušťka skla a poloměr zaoblení zaručují dostatečnou ochranu proti účinkům tepelného i mechanického namáhání.

TEXTILE

Dekoratívni nástěnné / stropní svítidlo

- difuzor: dekorativní sklo
 těleso: ocelový plech
 úchyty: galvanizovaný hliník
 - lisovaný difuzor zdobený potiskem a pískováním poskytuje rovnoměrný rozptýl světla
 - dekorativní hliníkové galvanizované úchyty ladí s jednoduchým tvarem difuzoru

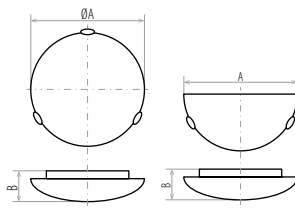
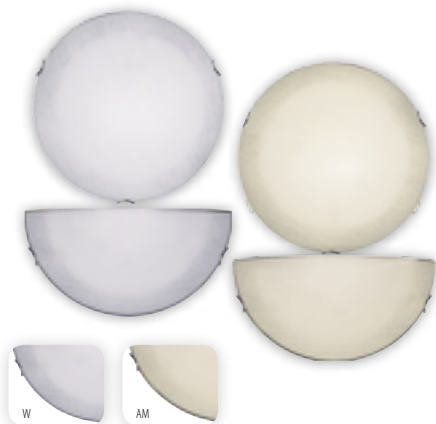

						a [mm]	b [mm]		DKC
1030 1/2 Y TEXTILE-W	GXIZ038	5901208000456	1x max 60	1x E27	bílá	300	90	500	301,- Kč
1030 1/2 Y TEXTILE-AM	GXIZ039	5901208000449	1x max 60	1x E27	ambra	300	90	500	301,- Kč
1030 MY TEXTILE-W	GXIZ040	5901208005451	1x max 60	1x E27	bílá	300	80	1000	358,- Kč
1030 MY TEXTILE-AM	GXIZ041	5901208005444	1x max 60	1x E27	ambra	300	80	1000	358,- Kč
1130 SY TEXTILE-W	GXIZ042	5901208020232	2x max 60	2x E27	bílá	400	95	1500	506,- Kč
1130 SY TEXTILE-AM	GXIZ043	5901208020225	2x max 60	2x E27	ambra	400	95	1500	506,- Kč
1230 DY TEXTILE-W	GXIZ044	5901208025091	3x max 40	3x E27	bílá	500	110	1900	987,- Kč
1230 DY TEXTILE-AM	GXIZ045	5901208025084	3x max 40	3x E27	ambra	500	110	1900	987,- Kč



Úchyty

Dekoratívni úchyty korespondují s jednoduchým tvarem difuzoru. Jsou vyrobeny z galvanizovaného tlakového litého hliníku. Na rozdíl úchyť z plastu, které se používají u levných náhražek, se nedeformují a zajišťují tak bezpečné a stabilní připevnění difuzoru k montáži.



Připojení k napájení

Svítidla obsahují svorkovnici pro připojení k napájení. Verze s více světelnými zdroji jsou navíc vybaveny kabeláží. Montáž a připojení nejsou díky tomu obtížné a ani náročné na čas. Celá instalace je tedy rychlá a snadná.



Objímky

Všechny typy jsou osazeny keramickými objímkami. Oproti plastovým náhražkám nezloutnou, nekřehnou a netaví se při vyšších teplotách.



Balení

Každý kus je zabalen ve vlastní krabici. Difuzor je chráněn v bublinkové folii. Takovýto způsob balení chrání výrobek před náhodným poškozením například při přepravě.



Difuzor

Difuzor je vyroben z lisovaného odolného skla. Jeho struktura zaručuje rovnoměrné rozptýlení světla. Z vnitřní strany je difuzor zdoben potiskem, z vnější potom upraven pískováním. Kvalitní provedení, tloušťka skla a poloměr zaoblení zaručují dostatečnou ochranu proti účinkům tepelného i mechanického namáhání.

DR-PLAFON

Dekoratívni nástenné / stropní svítidlo

difuzor: dekoratívni sklo
prsten: dřevo
těleso: ocelový plech
úchyty: mosaz

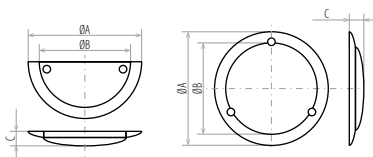

- lisovaný difuzor zdobený potiskem a pískováním poskytuje rovnomerný rozptyl světla
- dekoratívni prsten montury je z masivního dřeva opracovaného s důrazem na jeho přirozenou strukturu



						a [mm]	b [mm]	c [mm]		DKC
1030 1/2 DR PINE F/S	GXIZ046	8592660107301	1x max 60	1x E27	borovice	300	250	76	500	262,- Kč
1030 1/2 DR OAK F/S	GXIZ047	8592660107318	1x max 60	1x E27	dub	300	250	76	500	262,- Kč
1030 1/2 DR ALDER F/S	GXIZ048	8592660107325	1x max 60	1x E27	olše	300	250	76	500	262,- Kč
1030 1/2 DR WENGE F/S	GXIZ049	8592660107332	1x max 60	1x E27	wenge	300	250	76	500	262,- Kč
1030 MDR PINE F/S	GXIZ050	8592660107349	1x max 60	1x E27	borovice	260	200	78	750	275,- Kč
1030 MDR OAK F/S	GXIZ051	8592660107356	1x max 60	1x E27	dub	260	200	78	750	275,- Kč
1030 MDR ALDER F/S	GXIZ052	8592660107363	1x max 60	1x E27	olše	260	200	78	750	275,- Kč
1030 MDR WENGE F/S	GXIZ053	8592660107370	1x max 60	1x E27	wenge	260	200	78	750	275,- Kč
1030 SDR PINE F/S	GXIZ054	8592660107387	1x max 60	1x E27	borovice	300	250	75	950	292,- Kč
1030 SDR OAK F/S	GXIZ055	8592660107394	1x max 60	1x E27	dub	300	250	75	950	292,- Kč
1030 SDR ALDER F/S	GXIZ056	8592660107400	1x max 60	1x E27	olše	300	250	75	950	292,- Kč
1030 SDR WENGE F/S	GXIZ057	8592660107417	1x max 60	1x E27	wenge	300	250	75	950	292,- Kč
1130 DDR PINE F/S	GXIZ058	8592660107424	2x max 60	2x E27	borovice	380	315	85	1600	420,- Kč
1130 DDR OAK F/S	GXIZ059	8592660107431	2x max 60	2x E27	dub	380	315	85	1600	420,- Kč
1130 DDR ALDER F/S	GXIZ060	8592660107448	2x max 60	2x E27	olše	380	315	85	1600	420,- Kč
1130 DDR WENGE F/S	GXIZ061	8592660107455	2x max 60	2x E27	wenge	380	315	85	1600	420,- Kč



Úchyty

Ozdobné úchyty korespondují s jednoduchým tvarem krytu. Jsou vyrobeny z mosazi. Tento materiál zabezpečuje uchování vzhledu úchyty po dlouhou dobu.



Dřevěný prsten

Vyrobeno z masivního, impregnovaného dřeva s povrchovou úpravou, která podtrhuje jeho přirozenou strukturu. Dodatečné frézování na přední straně ještě umocňuje vzhled a charakter svítidla.



Připojení k napájení

Svítidla obsahují svorkovnici pro připojení k napájení. Verze s více světelnými zroji jsou navíc vybaveny kabeláží. Montáž a připojení nejsou díky tomu obtížné a ani náročné na čas. Celá instalace je tedy rychlá a snadná.



Objímky

Všechny typy jsou osazeny keramickými objímkami. Oproti plastovým náhražkám nežloutnou, nekřehnou a netaví se při vyšších teplotách.

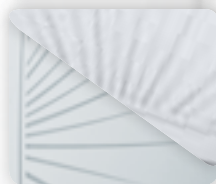

Difuzor

Difuzor je vyroben z lisovaného odolného skla. Jeho struktura zaručuje rovnoměrné rozptýlení světla. Z vnitřní strany je difuzor zdoben potiskem, z vnější potom upraven pískováním. Kvalitní provedení, tloušťka skla a poměr zaoblení zaručují dostatečnou ochranu proti účinkům tepelného i mechanického namáhání.

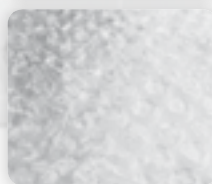

Balení

Každý kus je zabalen ve vlastní krabici. Difuzor je chráněn v bublinkové folii. Takovýto způsob balení chrání výrobek před náhodným poškozením například při přepravě.



MARGARITA

Dekorativní nástěnné / stropní svítidlo

difuzor: dekorativní sklo
 těleso: ocelový plech
 úchyty: galvanizovaný hliník

- lisovaný difuzor zdobený potiskem a pískováním poskytuje rovnoměrný rozptyl světla
- dekorativní galvanizované hliníkové úchyty ladí s jednoduchým tvarem difuzoru

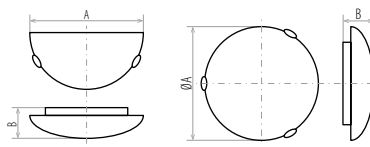

						a [mm]	b [mm]		DKC
1030 1/2 Y MARGARITA-W	GXIZ062	8592660107462	1x max 60	1x E27	bílá	300	90	550	446,- Kč
1030 1/2 Y MARGARITA-AM	GXIZ063	8592660107479	1x max 60	1x E27	ambra	300	90	550	446,- Kč
1030 MY MARGARITA-W	GXIZ064	8592660107486	1x max 60	1x E27	bílá	300	80	1000	725,- Kč
1030 MY MARGARITA-AM	GXIZ065	8592660107493	1x max 60	1x E27	ambra	300	80	1000	725,- Kč
1130 SY MARGARITA-W	GXIZ066	8592660107509	2x max 60	2x E27	bílá	400	95	1500	997,- Kč
1130 SY MARGARITA-AM	GXIZ067	8592660107516	2x max 60	2x E27	ambra	400	95	1500	997,- Kč

Úchyty

Dekorativní úchyty korespondují s jednoduchým tvarem difuzoru. Jsou vyrobeny z galvanizovaného tlakově litého hliníku. Na rozdíl úchyty z plastu, které se používají u levných náhražek, se nedeformují a zajišťují tak bezpečné a stabilní připevnění difuzoru k montáži.

Připojení k napájení

Svítilna obsahují svorkovnici pro připojení k napájení. Verze s více světelnými zroji jsou navíc vybaveny kabeláží. Montáž a připojení nejsou díky tomu obtížné a ani náročné na čas. Celá instalace je tedy rychlá a snadná.

Objímky

Všechny typy jsou osazeny keramickými objímkami. Oproti plastovým náhražkám nezloutnou, nekřehnou a netaví se při vyšších teplotách.

Balení

Každý kus je zabalen ve vlastní krabici. Difuzor je chráněn v bublinkové folii. Takovýto způsob balení chrání výrobek před náhodným poškozením například při přepravě.



Difuzor

Difuzor je vyroben z lisovaného odolného skla. Jeho struktura zaručuje rovnoměrné rozptýlení světla. Z vnitřní strany je difuzor zdoben potiskem, z vnější potom upraven pískováním. Kvalitní provedení, tloušťka skla a poloměr zaoblení zaručují dostatečnou ochranu proti účinkům tepelného i mechanického namáhání.

GERBERA

Dekoratívny nástenné / stropné svietidlo

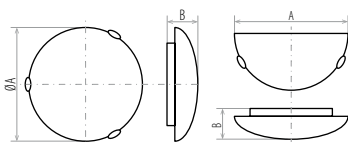
- difuzor: dekoratívny sklo
 těleso: ocelový plech
 úchyty: galvanizovaný hliník
 - lisovaný difuzor zdobený potiskem a pískováním poskytuje rovnomerný rozptyl světla
 - dekoratívny galvanizovaný hliníkový úchyty ladí s jednoduchým tvarem difuzoru



						a [mm]	b [mm]		DKC
1030 1/2 Y GERBERA	GXIZ068	8592660107523	1x max 60	1x E27	bílá	300	90	500	324,- Kč
1030 MY GERBERA	GXIZ069	8592660107530	1x max 60	1x E27	bílá	300	80	1000	394,- Kč
1130 SY GERBERA	GXIZ070	8592660107547	2x max 60	2x E27	bílá	400	95	1500	615,- Kč



Úchyty

Dekoratívny úchyty korespondujú s jednoduchým tvarem difuzoru. Jsou vyrobeny z galvanizovaného tlakově litého hliníku. Na rozdíl úchytů z plastu, které se používají u levných náhražek, se nedeformují a zajišťují tak bezpečné a stabilní připevnění difuzoru k montáži.



Objímky

Všechny typy jsou osazeny keramickými objímkami. Oproti plastovým náhražkám nežloutnou, nekřehnou a netaví se při vyšších teplotách.



Przyłączenie do zasilania

Svietidla obsahujú svorkovnicu pro připojení k napájení. Verze s více světelnými zroji jsou navíc vybaveny kabeláží. Montáž a připojení nejsou díky tomu obtížné a ani náročné na čas. Celá instalace je tedy rychlá a snadná.



Balení

Každý kus je zabalen ve vlastní krabici. Difuzor je chráněn v bublinkové folii. Takovýto způsob balení chrání výrobek před náhodným poškozením například při přepravě.



Difuzor

Difuzor je vyroben z lisovaného odolného skla. Jeho struktura zaručuje rovnoměrné rozptýlení světla. Z vnitřní strany je difuzor zdoben potiskem, z vnější potom upraven pískováním. Kvalitní provedení, tloušťka skla a poloměr zaoblení zaručují dostatečnou ochranu proti účinkům tepelného i mechanického namáhání.

KABINET

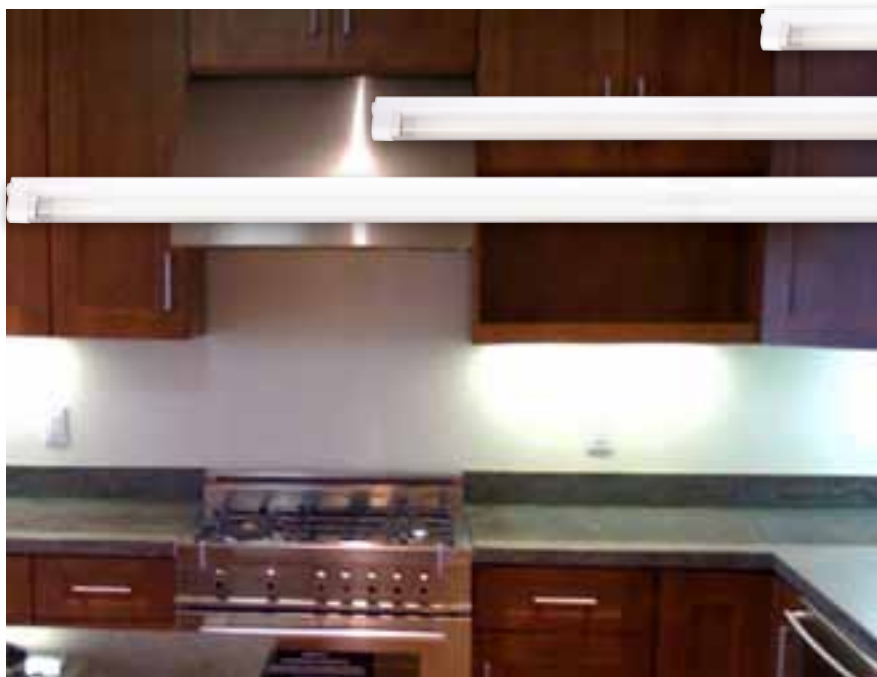

Nábytkové zářivkové svítidlo

- Možnost průběžného propojení svítidel pomocí propojovací šňůry GXIP005
- Všechny svítidla obsahují vypínač
- Svítidlo včetně zářivky
- Matný prismatický difuzor

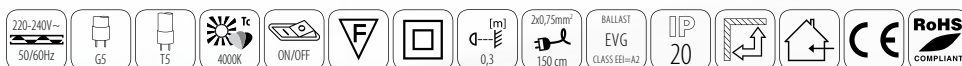
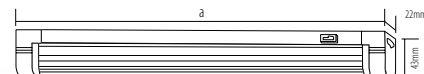

					a [mm]			DKC
KABINET 8W	GXIP001	8592660103761	bílá	8W	342	255g	1-30	189,- Kč
KABINET 13W	GXIP002	8592660103778	bílá	13W	570	350g	1-30	219,- Kč
KABINET 21W	GXIP003	8592660103785	bílá	21W	922	485g	1-20	305,- Kč
KABINET 28W	GXIP004	8592660103792	bílá	28W	1203	635g	1-20	419,- Kč

Príslušenství

Propojovací kabel k nábytkovému zářivkovému svítidlu

- Propojovací kabel slouží k průběžnému propojení svítidel KABINET

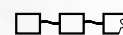
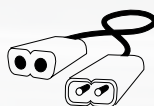

KABINET 8W	max 18
KABINET 13W	max 11
KABINET 21W	max 7
KABINET 28W	max 5



DKC

KABINET propojovací kabely

GXIP005

8592660103808

19,- Kč

SIRIOS



Nouzové svítidlo

- vhodné pro nouzové osvětlení únikových a evakuačních cest
- vhodné pro použití piktogramů
- součástí je zářivka FL8W T5/G5
- interní testovací tlačítko a LED kontrolka
- obsahuje vlastní vyjímatelnou baterii
- nízkoprofilová základna (ABS) a difuzor z polykarbonátu (PC)
- stupeň krytí IP42 (IP65 volitelné)
- snadná montáž (volitelné zapuštění)
- *4-letá záruka (s výjimkou lampy a baterie)



Vestavěné testovací tlačítko umístěné pod difuzorem

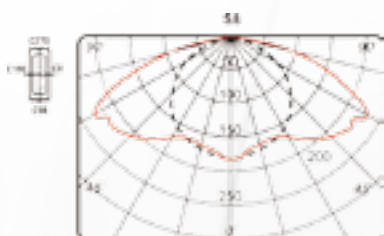
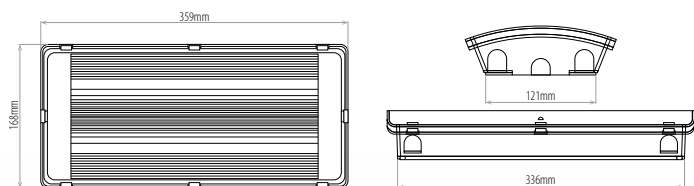

h	Rozstaw dla 1 lx				Rozstaw dla 0,5 lx			
	03,06	08,45	02,25	05,84	04,73	10,37	03,42	07,27
02,20	03,06	08,45	02,25	05,84	04,73	10,37	03,42	07,27
02,40	03,07	08,66	02,25	06,03	04,83	10,78	03,52	07,48
02,60	03,02	08,86	02,21	06,20	04,93	11,15	03,60	07,71
02,80	02,94	08,76	02,19	06,26	04,88	11,48	03,63	08,00
03,00	02,83	08,67	02,13	06,34	04,83	11,78	03,67	08,26
03,20	02,67	08,68	02,06	06,40	04,84	12,04	03,70	08,43
03,50	02,33	08,68	01,92	06,32	04,84	12,37	03,66	08,64
04,00	01,49	08,26	01,50	06,16	04,63	12,23	03,58	08,88

				Světelný zdroj	Typ použití svítidla			DKC
SIRIOS O-S8	GXN0001	8592660107653	bilá	FL8W T5/G5 450lm	nouzové	85	90min	1330,- Kč

Příslušenství

		Popis	DKC
SIRIOS O-S-RB	GXN0002	Montážní krabice	293,- Kč
SIRIOS O-S-IP	GXN0003	Sada IP65	434,- Kč

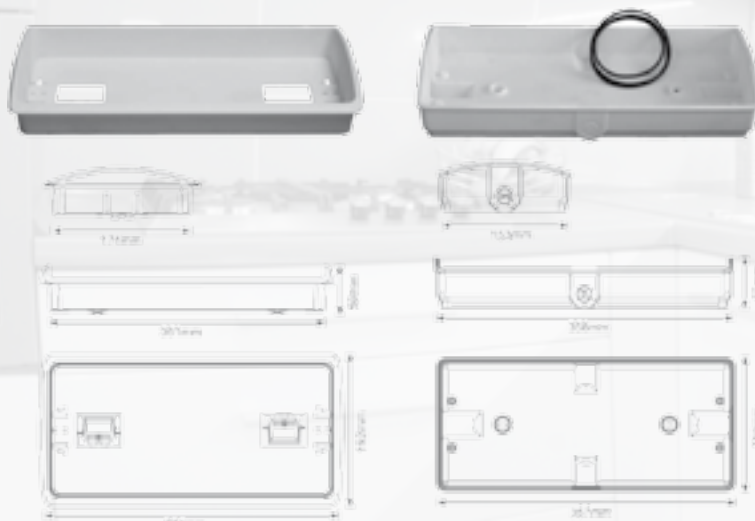

4 YEAR *
GUARANTEE

COOPER Safety

UGO

Zářivkové svítidlo

těleso svítidla: ocelový plech
 předřadník: indukční (VVG)
 - možnost doplnění o reflektor

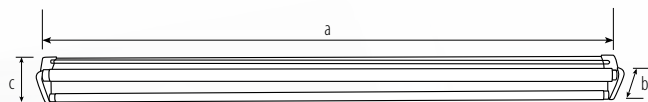
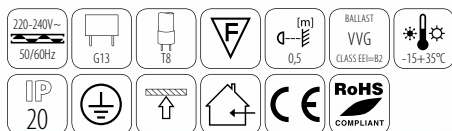

					a [mm]	b [mm]	c [mm]			DKC
UGO 1x18W	GXIK006	8592660104058	bílá	18	620	55	80	0,85 kg	1-10	240,- Kč
UGO 2x18W	GXIK003	8592660101392	bílá	2x18	620	100	80	0,90 kg	1-10	269,- Kč
UGO 1x36W	GXIK001	8592660101378	bílá	36	1230	55	80	1,10 kg	1-10	249,- Kč
UGO 2x36W	GXIK004	8592660101408	bílá	2x36	1230	100	80	1,80 kg	1-10	439,- Kč
UGO 1x58W	GXIK002	8592660101385	bílá	58	1535	55	80	1,70 kg	1-10	389,- Kč
UGO 2x58W	GXIK005	8592660101415	bílá	2x58	1530	100	80	2,60 kg	1-10	619,- Kč

UGO REFLECTOR

Samostatný reflektor pro svítidla UGO

Při požadavku svítidla UGO s reflektorem
 je potřeba objednat svítidlo a reflektor.

			DKC
Reflektor - UGO 1x18W	GXOS076	8592660105789	79,- Kč
Reflektor - UGO 2x18W	GXOS079	8592660106922	102,- Kč
Reflektor - UGO 1x36W	GXOS010	8592660102795	79,- Kč
Reflektor - UGO 2x36W	GXOS011	8592660102801	99,- Kč
Reflektor - UGO 1x58W	GXOS067	8592660105796	109,- Kč
Reflektor - UGO 2x58W	GXOS068	8592660105802	139,- Kč

TOR1



Svítlidlo přisazené

těleso svítidla: plast
difuzor: sklo
- voděodolné

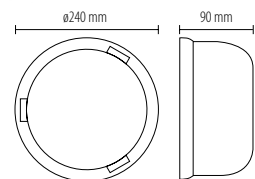

						DKC
TOR 1-100	GXTT006	8592660103426	bílá	100	900	149,- Kč

TOR2



Svítlidlo přisazené

těleso svítidla: plast
difuzor: sklo
- voděodolné

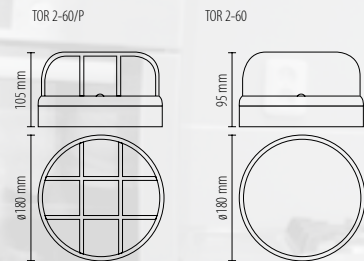

							DKC
TOR 2-60/P	GXTT004	8592660103402	bílá	60	plast	710	109,- Kč
TOR 2-60	GXTT005	8592660103419	bílá	60	-	700	109,- Kč

TOR 3



Svítlidlo přisazené

těleso svítidla: plast
difuzor: sklo
- voděodolné

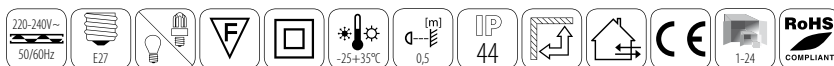
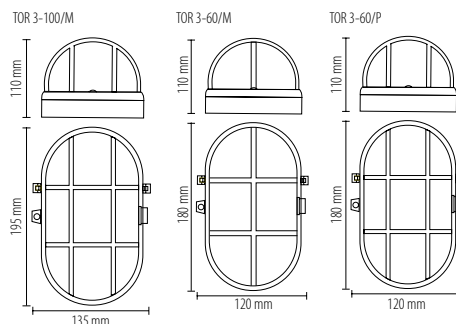

							DKC
TOR 3-60/M	GXTT001	8592660103372	bílá	60	kov	470	69,- Kč
TOR 3-60/P	GXTT002	8592660103389	bílá	60	plast	470	69,- Kč
TOR 3-100/M	GXTT003	8592660103396	bílá	75	kov	540	99,- Kč

RONDE E27



Svítlidlo přisazené

těleso svítidla: plast
difuzor: sklo
- voděodolné

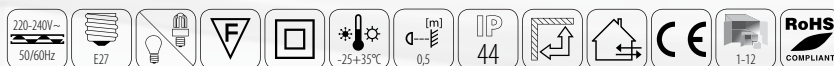
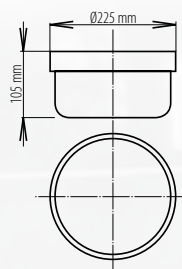

						DKC
RONDE E27	GXTT008	8592660104416	bílá	100	1100	139,- Kč

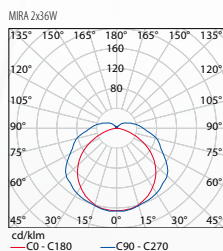
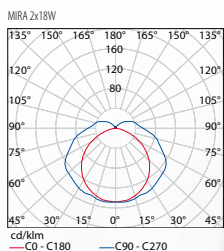

Zářivkové svítidlo
 těleso svítidla: ocelový plech/plast
 difuzor: polystyren (PS)
 předřadník: elektronický (EVG)

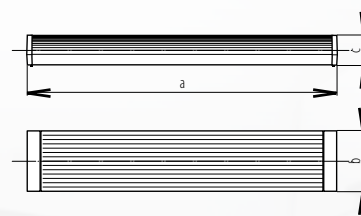

					a [mm]	b [mm]	c [mm]			DKC		
MIRA EVG 2x18W	GXZS004	8592660105383	průhledný	2x18	650	152	64	950	1-8	429,- Kč		
MIRA EVG 2x36W	GXZS003	8592660105376	průhledný	2x36	1255	152	64	1550	1-4	699,- Kč		
							a [mm]	b [mm]	c [mm]			DKC
MIRA EVG 2x18W emergency	GXZS010	8592660109978	průhledný	2x18	1500	2:20	650	152	64	1450	1-8	1529,- Kč
MIRA EVG 2x36W emergency	GXZS009	8592660108025	průhledný	2x36	1500	1:19	1255	152	64	2050	1-4	1940,- Kč

Príslušenství

				DKC
Difuzor - MIRA matt 2x18	GXZS005	8592660105819	matný	99,- Kč
Difuzor - MIRA matt 2x36	GXZS006	8592660105826	matný	199,- Kč

ELEKTROINSTALAČNÍ MATERIÁL



SENSOR HF 360°



Mikrovláňné pohybové čidlo

- maximální zatížení: 1200W

- rozsah čidla: 360°

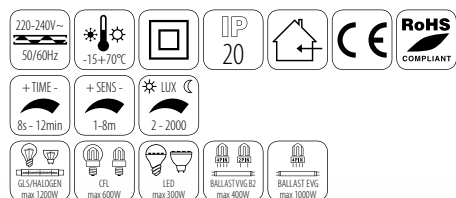
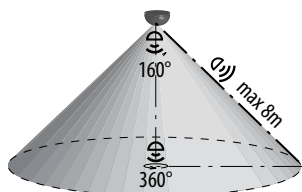
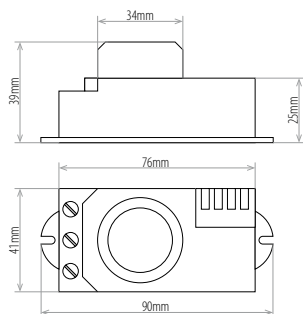

							DKC
SENSOR HF 360	GXS1006	8592660110059	□ bílá	360	160	max 8m	410,- Kč

SENSOR 10/20



Pohybové čidlo

- maximální zatížení: 1200W

- rozsah čidla: 360°

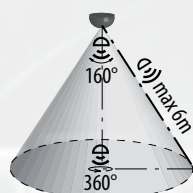
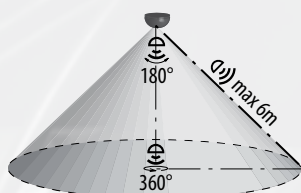
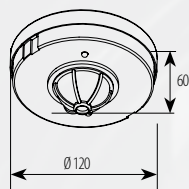

							DKC
SENSOR 10	GXS1001	8592660100876	□ bílá	360	160	max 6m	199,- Kč
SENSOR 20	GXS1002	8592660100883	□ bílá	360	180	max 6m	259,- Kč

SENSOR 30

Pohybové čidlo

- maximální zatížení: 1200W
- rozsah čidla: 360°

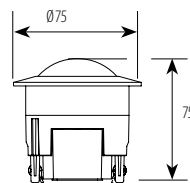

360° LED COMPATIBLE

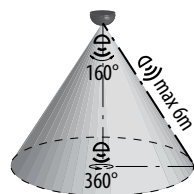

							DKC
SENSOR 30	GXSI003	8592660100890	☐ bílá	360	160	max 6m	269,- Kč

SENSOR 40

Pohybové čidlo

- maximální zatížení: 600W
- rozsah čidla: 140°

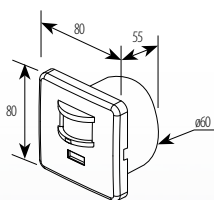
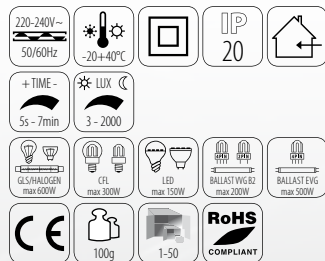

LED COMPATIBLE

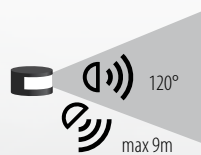

							DKC
SENSOR 40	GXSI004	8592660100906	☐ bílá	140	140	max 9m	269,- Kč

SENSOR 70

Pohybové čidlo

- maximální zatížení: 1200W
- rozsah čidla: 180°

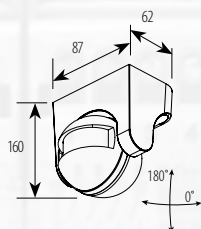
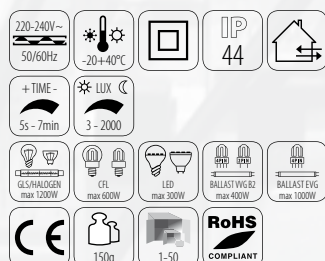

LED COMPATIBLE

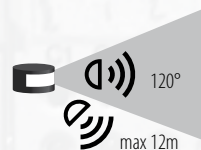

							DKC
SENSOR 70 W	GXSE003	8592660100838	■ černá	180	180	max 12m	299,- Kč
SENSOR 70 B	GXSE004	8592660100845	☐ bílá	180	180	max 12m	299,- Kč

DRIVER LED IP67



Elektronický DRIVER LED

- odolné proti zkratu
- s tepelnou ochranou
- 2 x obvody V+ - V-

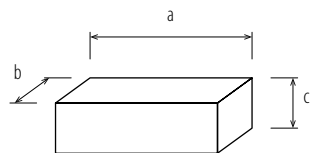

							a [mm]	b [mm]	c [mm]			DKC
DRIVER LED IP67 30W	GXLD008	8592660105239	90-264V / 50-60Hz	2,5 A	30	0-30	202	28	20	250	1-74	499,- Kč
DRIVER LED IP67 100W	GXLD009	8592660105246	170-264V / 50-60Hz	8,3 A	100	0-100	248	72	45	1230	1-15	1279,- Kč
DRIVER LED IP67 150W	GXLD010	8592660105253	170-264V / 50-60Hz	12,5 A	150	0-150	248	72	45	1270	1-15	1909,- Kč

DRIVER IP20



Elektronický DRIVER

- odolné proti zkratu
- s tepelnou ochranou
- 15W, 40W: 1 x obvod V+ - V-
- 75W, 100W, 150W: 2 x obvody V+ - V-

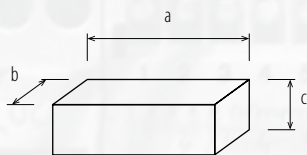

						a [mm]	b [mm]	c [mm]			DKC
DRIVER 15W	GXLD003	8592660105185	87-264V / 47-60Hz	1,2 A	15	77	47	20	90g	1-100	259,- Kč
DRIVER 25W	GXLD014	8592660109435	87-264V / 47-60Hz	2,1 A	25	90	59	38	120g	1-100	349,- Kč
DRIVER 40W	GXLD004	8592660105192	87-264V / 47-63Hz	3,5 A	40	111	71	36	210g	1-100	399,- Kč
DRIVER 75W	GXLD005	8592660105208	87-264V / 47-63Hz	6 A	75	158	97	38	310g	1-36	509,- Kč
DRIVER 100W	GXLD006	8592660105215	115/230V / 50-60Hz	8,5 A	100	205	98	41	480g	1-25	599,- Kč
DRIVER 150W	GXLD007	8592660105222	115/230V / 50-60Hz	12,5 A	150	205	98	41	500g	1-25	649,- Kč
DRIVER 200W	GXLD015	8592660109442	115/230V / 50-60Hz	16,5 A	200	205	98	41	530g	1-25	955,- Kč

TRAFO



Elektronický transformátor

- odolné proti zkratu
- s tepelnou ochranou

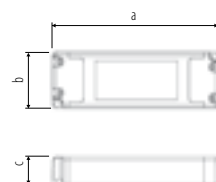

						a [mm]	b [mm]	c [mm]			DKC
TRAFO ET20	GXOS053	8592660103457	bílá	20	10-20	65	35	20	50g	1-200	127,- Kč
TRAFO ET60	GXOS054	8592660103518	bílá	60	20-60	110	36	21	80g	1-104	169,- Kč
TRAFO ET105	GXOS055	8592660103501	bílá	105	35-105	130	43	21	115g	1-80	189,- Kč
TRAFO ET150	GXOS056	8592660103495	bílá	150	50-150	152	43	31	200g	1-45	329,- Kč
TRAFO ET210	GXOS057	8592660103488	bílá	210	50-210	160	46	33	220g	1-45	389,- Kč

GPG

Kabelová průchodka

- samozhášivý plast Poliamid 6.6
- neoprenové těsnění
- závit typu PG

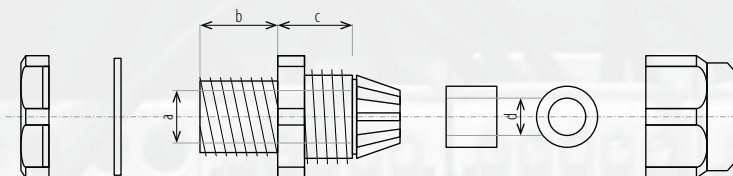

				a [mm]	b [mm]	c [mm]	d [mm]			DKC
GPG-7	GXOS180	8592660109534	šedá	8	8	12,8	6	3,5-6	100	5,20 Kč
GPG-9	GXOS181	8592660109541	šedá	9,9	8,11	13,9	7	4-8	100	5,60 Kč
GPG-11	GXOS182	8592660109558	šedá	13,2	8,2	15,4	9,6	5-10	100	7,10 Kč
GPG-13,5	GXOS183	8592660109565	šedá	15,2	8,9	15,8	11,7	6-12	100	7,50 Kč
GPG-16	GXOS184	8592660109572	šedá	17,2	8,9	17,3	12,9	1-10	100	8,90 Kč
GPG-21	GXOS185	8592660109589	šedá	22,4	10,8	18,6	16,5	13-18	50	12,90 Kč
GPG-29	GXOS186	8592660109596	šedá	30,6	10,9	20,5	23,3	18-25	25	24,- Kč
GPG-36	GXOS187	8592660109602	šedá	35,2	14,4	24,4	33,3	22-32	10	42,60 Kč
GPG-42	GXOS188	8592660109619	šedá	39,3	14,6	25,4	39,6	30-38	10	52,- Kč
GPG-48	GXOS189	8592660109626	šedá	45,4	15,8	25,2	45,1	34-44	10	61,30 Kč

BL - EVG



Předřadník EVG

- elektronický předřadník (EVG)
- Třída energetické účinnosti (Ei): A2

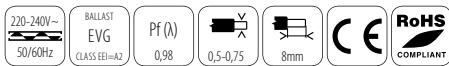
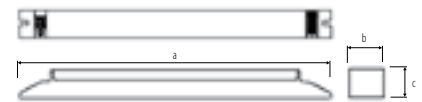

			a [mm]	b [mm]	c [mm]				U-out		DKC
						[W]	Ta [°C]	Tc [°C]		[g]	
BL - EVG 2x36W	GXOS030	8592660102689	275	28	26	2x36	-25 +50	75	<450V	260g	289,- Kč
BL - EVG 2x58W	GXOS031	8592660102696	336	33	29	2x58	-25 +50	75	<450V	300g	359,- Kč
BL - EVG DP 2x36W*	GXOS003	8592660101460	278	30	30	2x36	-15 +50	70	<250V	240g	379,- Kč
BL - EVG DP 2x58W*	GXOS009	8592660101521	315	30	30	2x58	-15 +50	70	<250V	300g	399,- Kč
BL - EVG RA 4x18W	GXOS015	8592660103754	280	37	31	4x18	-15 +50	70	<250V	300g	339,- Kč

*teplý start

BL - VVG

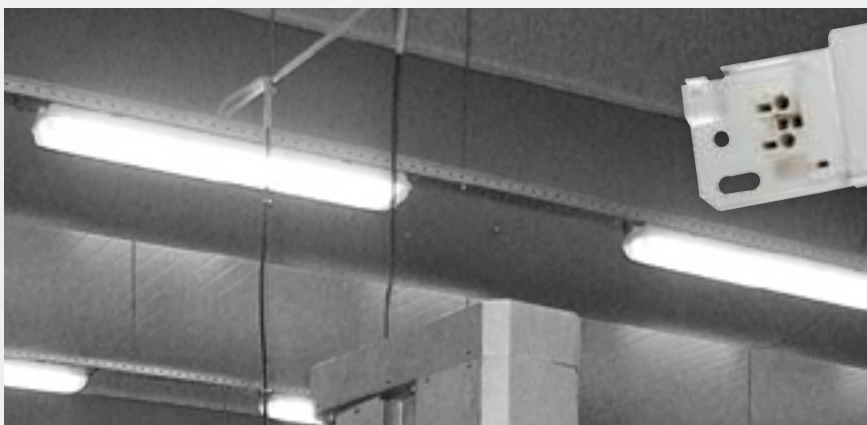

Předřadník EVG

- indukční předřadník (VVG)
- Třída energetické účinnosti (Ei): B2

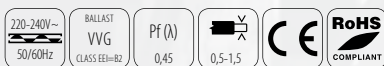
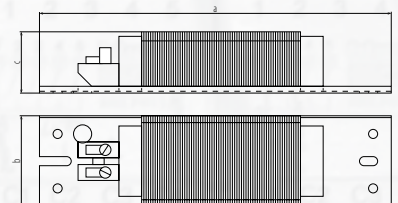

			a [mm]	b [mm]	c [mm]						DKC
						[W]	Ta [°C]	Tc [°C]	Tw [°C]	[g]	
BL - VVG 18W	GXOS052	8592660103365	155	42	28	18	-5 + 40	120	130	500g	129,- Kč
BL - VVG 36W	GXOS032	8592660102702	155	42	28	36	-5 + 40	120	130	500g	139,- Kč
BL - VVG 58W	GXOS033	8592660102719	195	42	28	58	-5 + 40	120	130	820g	199,- Kč

LH-E14

Keramická objímka

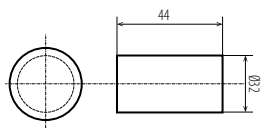

LH-E14



GXOS049



8592660103358

DKC

6,- Kč

LH-E27

Keramická objímka

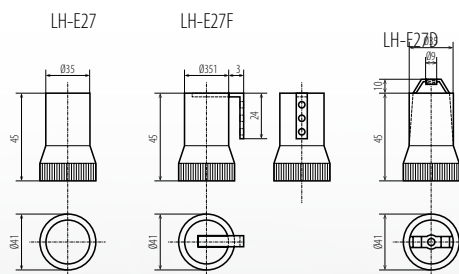

LH-E27



GXOS046



8592660103327

DKC

6,- Kč

LH-E27F

GXOS047

8592660103334

6,- Kč

LH-E27D

GXOS048

8592660103341

6,- Kč

ADAPTOR E27/GZ10 GU10

Keramická objímka



Adaptor E27/GZ10 GU10



GXLZ035



8592660104096

DKC

9,- Kč

LH-G9

Keramická objímka

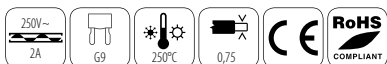
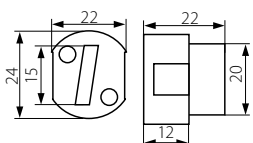

			DKC
LH-G9	GXOS069	8592660105390	10,- Kč

LH-GX5,3

Keramická objímka

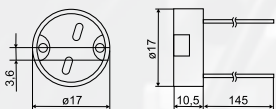

			DKC
LH-GX5,3	GXOS045	8592660103310	6,- Kč

LH-GZ10

Keramická objímka

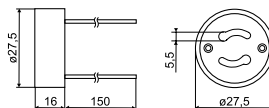

			DKC
LH-GZ10	GXOS043	8592660103297	9,- Kč

LH-R7S

Keramická objímka

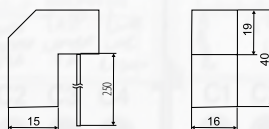

			DKC
LH-R7S	GXOS044	8592660103303	6,- Kč

RO

RO2-1 - Rozbočka typu 2x2P+Z / 1x2P
 RO3 - Rozbočka typu 3x2P+Z



RO2-1



RO3



				DKC
RO2-1	GXOS060	8592660103716	80	23,- Kč
RO3	GXOS061	8592660103723	85	28,- Kč

ZA / ZS

ZA - Zásuvka s ochranným kolíkem
 ZS - Zástrčka s ochranným kontaktem



ZA



ZS



				DKC
ZA	GXOS062	8592660103730	40	23,- Kč
ZS	GXOS063	8592660103747	40	23,- Kč

ZA / ZS IP44

ZA IP44 - Zásuvka s ochranným kolíkem
 ZS IP44 - Zástrčka s ochranným kontaktem
 - voděodolné



ZA IP44



ZS IP44



				DKC
ZA IP44	GXOS064	8592660103877	85	60,- Kč
ZS IP44	GXOS065	8592660103884	60	42,- Kč

WKW / WKD / WKU

Zástrčka

WKW - rozebíratelná zástrčka, s vypínačem, úhlová, s dvojitým systémem ochranných kontaktů pro spotřebiče I.třídy

WKD - rozebíratelná zástrčka s vypínačem a kontrolkou s dvojitým systémem ochranných kontaktů pro spotřebiče I.třídy

WKU - rozebíratelná zástrčka s úchytem, unischuko, pro spotřebiče I.třídy



WKW



WKD



WKU

NEW

				DKC
WKW	GXOS150	8592660109633	1-60	86,- Kč
WKD	GXOS151	8592660109640	1-60	104,- Kč
WKU	GXOS153	8592660109664	1-60	32,- Kč

WGP

zásuvka na prodlužovač

WGP - WGP - rozebíratelná zásuvka na prodlužovač s dvojitým systémem ochranných kontaktů pro spotřebiče I.třídy



WGP

NEW

				DKC
WGP	GXOS152	8592660109657	1-48	60,- Kč

GPH - WPH

GPH - voděodolná zásuvka, rozebíratelná, se šroubovacími kontakty, s ochranným kontaktem (2P+Z)

WPH - rozebíratelná zásuvka, s ochranným kontaktem pro spotřebiče I.třídy (2P+Z)





GPH IP44



WPH IP44

NEW

				DKC
GPH IP44	GXOS154	8592660109671	1-24	95,- Kč
WPH IP44	GXOS155	8592660109688	1-30	85,- Kč

STARTER

Startéry pro zářivky

STARTER 4 - 22W

STARTER 4 - 65W



STARTER 4 - 22W



STARTER 4 - 65W

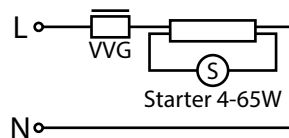
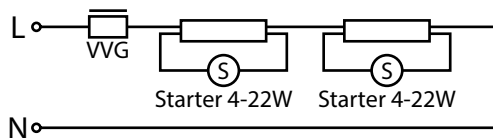
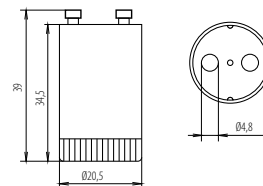

Starter 4-22W

Starter 4-65W



GXOS090

GXOS091



8592660104423

8592660104508



4-22

4-65

DKC

6- Kč

6- Kč

TB

Šroubová svorkovnice

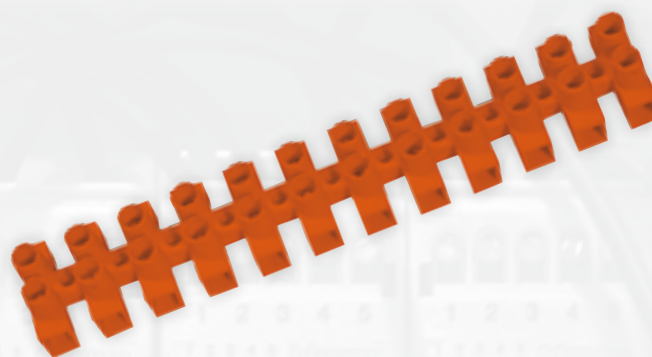
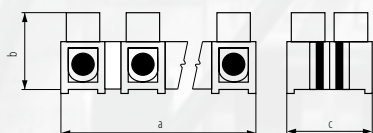

							a [mm]	b [mm]	c [mm]	DKC
TB - 2,5 mm PE	GXOS093	8592660104164	12P	1÷2,5 \square	oranžová	10-1000	76,4	13,0	17,0	*
TB - 4 mm PE	GXOS094	8592660104171	12P	1,5÷4 \square	oranžová	10-1000	94,8	15,5	18,8	*
TB - 6 mm PE	GXOS095	8592660104188	12P	2,5÷6 \square	oranžová	10-500	106,6	16,7	20,7	*
TB - 10 mm PE	GXOS096	8592660104195	12P	4÷10 \square	oranžová	10-500	115,1	18,7	22,6	*
TB - 16 mm PE	GXOS097	8592660104201	12P	6÷16 \square	oranžová	10-300	136,7	19,8	24,1	*





* Zboží dostupné jen v Polsku

UMPP

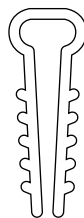
Montážní konzola

- pro ploché vodiče
- rychlá montáž, jistota upevnění
- profesionální vzhled instalace s nízkými náklady
- doporučený průměr vrtáku pro montáž \varnothing 6mm
- bílá barva
- 100 kusů v balení (cena za balení)



			Typ kabelu		DKC
UMPP-2	GXOS103	8592660105000	YDYp [2x1,5 ^o / 2x2,5 ^o / 3x1,0 ^o]	100-5000	43,- Kč
UMPP-3	GXOS104	8592660104997	YDYp [3x1,5 ^o / 3x2,5 ^o]	100-5000	43,- Kč
UMPP-4	GXOS106	8592660104973	YDYp [4x1,5 ^o / 4x2,5 ^o]	100-5000	51,- Kč
UMPP-5	GXOS111	8592660105505	YDYp [5x1,5 ^o / 5x2,5 ^o]	100-4500	59,- Kč

UMT

Oboustranná montážní konzola

- pro ploché vodiče
- rychlá montáž, jistota upevnění
- profesionální vzhled instalace s nízkými náklady
- doporučený průměr vrtáku pro montáž \varnothing 6mm
- bílá barva
- 100 kusů v balení (cena za balení)

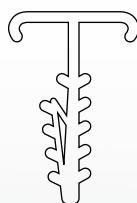



			Typ kabelu		DKC
UMT-3	GXOS105	8592660104980	YDYp 2x [2x1,5 ^o / 2x2,5 ^o]	100-3500	62,- Kč

UMPO

Montážní konzola



- pro vodiče s kruhovým průřezem
- rychlá montáž, jistota upevnění
- profesionální vzhled instalace s nízkými náklady
- doporučený průměr vrtáku pro montáž \varnothing 6mm
- bílá barva
- 100 kusů v balení (UMPO-6, UMPO-8, UMPO-10) (cena za balení);
- 50 kusů v balení (UMPO-16, UMPO-20) (cena za balení)



			Typ kabelu		DKC
UMPO-6	GXOS112	8592660105512	kabely do \varnothing 6mm	100-5000	43,- Kč
UMPO-8	GXOS107	8592660104966	kabely do \varnothing 8mm	100-5000	43,- Kč
UMPO-10	GXOS108	8592660104959	kabely do \varnothing 10mm	100-5000	43,- Kč
UMPO-16	GXOS109	8592660105093	kabely nebo trubky do \varnothing 16 mm	50-2500	43,- Kč
UMPO-20	GXOS110	8592660105109	kabely nebo trubky do \varnothing 20 mm	50-2500	43,- Kč

LEGENDA

OZNAČENÍ OCHRANY PŘED VZPLANUTÍM



SYMBOL	Vysvětlení
	Určeno k montáži na nehořlavé povrchy (kámen, beton)
	Určeno k montáži na normálně hořlavé povrchy. Teplota vzplanutí materiálu vyšší než 200°C.

TEPLoty CHROMATIČNOSTI



Teplota chromatičnosti Tc[K] je rovna teplotě černého zářiče, jehož záření má tutéž chromatičnost jako uvažované zařízení. Jinými slovy se jedná o objektivní míru barvy daného světelného zdroje.

	
<2700K	žlutě-bílá
2700K-3500K	teplá bílá
3500K-5000K	bílá (neutrální)
5000K-8000K	denní (studená bílá)
8000K-10000K	azurová (jasné nebe v poledne v zimě)
20000K	azurová (jasné nebe v poledne v létě)
28000-30000K	výboj blesku

OCHRANA PŘED ÚRAZEM ELEKTRICKÝM PROUDEM

Třída bezpečnosti	SYMBOL	Vysvětlení
0	-	Ochrana před úrazem elektrickým proudem je založena na základní izolaci. Ochrana před úrazem elektrickým proudem je zajištěna okolím a také polohou zařízení.
I		U zařízení třídy ochrany I je ochrana před úrazem elektrickým proudem zajištěna připojením neživých částí k ochrannému vodiči.
II		Zařízení třídy ochrany II nemají prostředky pro připojení ochranného vodiče, jsou vybaveny přídavnou nebo zesílenou izolací.
III		Ochrana před úrazem elektrickým proudem zařízení třídy III je založena na napájení bezpečným malým napětím.

VYSVĚTLENÍ STUPNÉ OCHRANY PŘED VNIKUTÍM PEVNÝCH PŘEDMĚTŮ

IP	SYMBOL	Vysvětlení
IPOX	-	Nechráněno
IP1X	-	Zařízení je chráněno před vniknutím pevných cizích těles o průměru 50mm a větších a před dotykem hřbetem ruky.
IP2X	-	Zařízení je chráněno před vniknutím pevných cizích těles o průměru 12,5mm a větších a před dotykem prstem.
IP3X	-	Zařízení je chráněno před vniknutím pevných cizích těles o průměru 2,5mm a větších a před dotykem nástrojem.
IP4X	-	Zařízení je chráněno před vniknutím pevných cizích těles o průměru 1mm a větších a před dotykem drátem.
IP5X		Částečně prachotěsné. Zařízení je chráněno před prachem a před dotykem drátem.
IP6X		Úplně prachotěsné. Zařízení je prachotěsné a je chráněno před dotykem drátem.

VYSVĚTLENÍ STUPNÉ OCHRANY PŘED VNIKUTÍM VODY

IP	SYMBOL	Vysvětlení
IPX0	-	Nechráněno.
IPX1	-	Svisle kapající.
IPX2	-	Kapající ve sklonu 15°.
IPX3		Venkovní prostředí. Kropení, déšť.
IPX4		Těsně zavřené proti stříkající vodě. Stříkající.
IPX5		Těsně zavřené proti proudící vodě. Tryskající.
IPX6		Do mokra. Intenzivně tryskající.
IPX7		Nepropustné, ponorné. Dočasné ponoření.
IPX8	-	Trvalé ponoření.

LEGENDA



DRUH ZDROJE SVĚTLA:

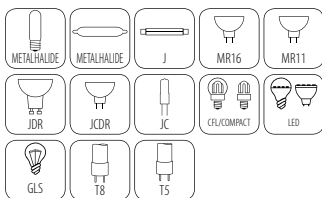

TYP PATICE:

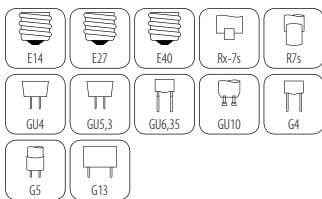

TYP ZATÍŽENÍ ČIDLA:



	název výrobku		minimální vzdálenost od osvětlovaného předmětu		mikrovlnný senzor
	kod / index		nevyžaduje použití v uzavřených svítidlech / s ochranným sklem		Pf (λ) účinnost (cos φ)
	čárový kód EAN		vyžaduje použití v uzavřených svítidlech / s ochranným sklem		elektrická odolnost izolace
	napájení		třída energetické účinnosti		typ reflektoru - symetrický / asymetrický
	příkon		energetická třída předřadníku		odpovídající výkon
	I. třída ochrany před úrazem el. proudem		životnost (h)		délka
	II. třída ochrany před úrazem el. proudem		rozsah teploty okolí		hmotnost
	III. třída ochrany před úrazem el. proudem		nehodné pro použití se stmívačem		balení
	světelný tok (lm)		vhodné pro použití se stmívačem		Hg množství rtuti
	teplota chromatičnosti (Tc)		odolnosti proti rychlému sledu zapnutí / vypnutí		shoda se směnicí EU o škodlivých látkách pro životní prostředí a zdraví
	index reprodukce barev (Ra)		čas k dosažení plného světelného výkonu		shoda s evropskými normami (CE)
	barva		vyzařovací úhel		
	technologie MCOB LED		tolerance pracovní pozice		
	technologie LED SMD		průměr kabelu		
	technologie LED / POWER LED		délka odizolování		
	k venkovnímu nebo vnitřnímu použití		délka přívodu		
	k vnitřnímu použití		přívod s vidlicí		
	k venkovnímu použití		vybaven vypínačem		
	k přisazení na zeď / strop		nastavení času		
	k přisazení ke stropu		regulace citlivosti		
	k zabudování do stropu		nastavitelný práh - režim noc / den		
	k montáži na běžně hořlavém povrchu		maximální vzdálenost detekce pohybu		
	stupeň krytí (IP)		horizontální úhel detekce		
	stupeň ochrany proti mechanickému poškození		vertikální úhel detekce		

Ceny uvedené v katalogu jsou bez DPH a bez recyklačních poplatků. Společnost Greenlux s.r.o. si vyhrazuje právo na změny. Aktuální sortiment a ceny zboží jsou uvedeny na www.greenlux.cz. Všem se omlouváme za případné tiskové chyby.



CZ GREENLUX s.r.o.,
Železniční II/174, 738 01 Staré Město u Frýdku-Místku, Česká republika
SKLAD – Greenlux s.r.o. (areál bývalého Slezanu 04)
Beskydská 1488, 738 01 Frýdek – Místek
sklad@greenlux.cz

IČ: 28 608 747
DIČ: CZ28608747
Tel.: 571 891 806
greenlux@greenlux.cz
www.GREENLUX.cz

SK GREENLUX s.r.o.
Bratislavská 51/123,
911 05 Trenčín, Slovensko

IČO: 45557756
DIČ: SK2023034794
Tel.: +421 327 430 884
greenlux@greenlux.sk
www.GREENLUX.sk

PL GREENLUX Sp. z o.o.
Biuro Handlowe: ul. Azotowa 21
41-503 Chorzów, Polska

Tel.: +48 32 888 61 00
Tel.: +48 32 888 61 01
biuro@greenlux.pl
www.GREENLUX.pl

HU GREENLUX Kft.
Mester utca 1,
9023 Győr,
Magyarország

Csz.: 08-09-024146
Asz.: 24126139-2-08
Tel.: +36 96 823 303
greenlux@greenlux.hu
www.GREENLUX.hu