



EGLO  
my light | my style



Außenleuchten

Outdoor luminaires

Luminaires extérieurs

2016/17





Dear customers and business partners,  
loyal EGLO friends,

what could be more beautiful than spending time in the nature? We offer you the perfect lightning for your garden, your terrace and balcony. Our assortment of outdoor luminaires ranges from classic, to traditional, modern and extravagant luminaires. Explore and find your favorite for every matching atmosphere and enhance your personal sense of well-being.

Have fun flipping through our outdoor luminaire range!

Geschätzte Kunden und Geschäfts-  
partner, treue EGLO-Freunde,

Was gibt es Schöneres als die Zeit im Grünen zu verbringen? Wir bieten Ihnen dazu die perfekte Beleuchtung für Ihren Garten, Ihre Terrasse oder Ihren Balkon. Unser Sortiment an Außenleuchten reicht von klassischen, über traditionelle bis hin zu modernen und extravaganten Leuchten. Finden Sie Ihre Favoriten der für die passende Atmosphäre und Ihren persönlichen Wohlfühleffekt sorgt.

Viel Spaß beim Durchstöbern unseres Außenleuchtensortiments!

Très chers clients et partenaires, fidèles  
amis de EGLO,

Qu'il y a t'il de plus agréable que de passer du temps à l'extérieur ? Nous vous proposons l'éclairage parfait pour le jardin, la terrasse ou le balcon. Notre palette d'éclairages extérieurs s'étend des modèles classiques et traditionnels aux éclairages modernes et extravagants. Vous trouverez vos éclairages préférés pour créer une atmosphère adaptée et pour votre bien-être personnel.

Amusez-vous à parcourir notre gamme d'éclairages extérieurs !

Mag. René Tiefenbacher  
CEO EGLO Group



	<b>Highlights</b> Sensor luminaires & Sensors Sensorleuchten & Sensoren Luminaires capteur & Capteurs	004 - 009
---	--	-----------

## Products

	<b>Modern</b> Modern Moderne	010 - 068
---	------------------------------------	-----------

	<b>Classic</b> Klassik Classique	069 - 117
--	--	-----------

	<b>Spots, Recessed &amp; Accessories</b> Spots, Einbauleuchten & Zubehör Spots, luminaires encastrés & accessoires	118 - 131
---	--	-----------

## Concepts

	<b>Garden Living</b>	132 - 137
---	----------------------	-----------

## Appendix

	<b>Register &amp; Legend</b> Register & Légende Registre & Légende	138 - 144
---	--	-----------



› Safe Money



› Hands free



› Safe Steps



› Security

# Light at the right time

## Light at the right time

Smart light activated by movement offers many advantages. It frightens uninvited guests, protects you and your family from confusing sleepers and falls, and after shopping, your hands remain free to carry your bags. EGLO sensors and sensors provide you with a great deal of comfort in your daily life and increase the safety of your own four walls. You also do not have to worry about the efficient and sustainable use of electricity, because nobody forgets to turn off the light. This saves money and reduces energy costs by up to 90%

## Licht zum richtigen Zeitpunkt

Smartes Licht, das durch Bewegungen aktiviert wird, bietet Ihnen viele Vorteile. Es schreckt ungebetene Gäste ab, schützt Sie und ihre Familie vor unübersichtlichen Schwellen sowie Stolperfallen und nach dem Einkauf bleiben die Hände frei um Ihre Taschen zu tragen. Mit den Sensorleuchten und Sensoren von EGLO bringen Sie erheblichen Komfort in Ihren Alltag und erhöhen die Sicherheit Ihrer eigenen vier Wände. Außerdem müssen Sie sich keine Gedanken mehr über effiziente und nachhaltige Verwendung von Strom machen, denn niemand vergisst mehr das Licht auszuschalten. Das spart Geld und senkt die Energiekosten um bis zu 90%

## Lumière au bon moment

Lumière intelligente, qui est activé par le mouvement, offre de nombreux avantages. Elle dissuade les visiteurs indésirables, protège vous et votre famille de confondre les seuils et le déclenchement et après le shopping rester les mains libres pour porter vos sacs. Avec les lumières des capteurs et des capteurs de EGLO apporter un confort considérable dans votre vie quotidienne et d'augmenter la sécurité de vos propres quatre murs. En outre, vous ne devez pas vous soucier de l'utilisation efficace et durable de l'énergie, parce que personne n'oubliera plus éteindre la lumière. Cela permet d'économiser de l'argent et réduit les coûts d'énergie jusqu'à 90%



Chapter / Kapitel / Chapitre **Modern**



**POLIENTO**  
p. 14



**TRONO STICK**  
p. 20



**HELSINKI**  
p. 26



**HELSINKI**  
p. 26



**HELSINKI**  
p. 27



**NISIA**  
p. 28



**ATOLLARI**  
p. 34



**ATOLLARI**  
p. 34



**SESIMBA 1**  
p. 40



**SESIMBA 1**  
p. 40



**SESIMBA 1**  
p. 40



**BREGANZO 1**  
p. 51



**BREGANZO 1**  
p. 51



**CITY LED**  
p. 54



**CITY 1**  
p. 55



**CITY**  
p. 55



**CITY**  
p. 55



**CERNO**  
p. 138



**CERNO**  
p. 56



**RALORA 1**  
p. 57



**TRABADA**  
p. 58



**TRABADA**  
p. 58



Chapter / Kapitel / Chapitre Classic



**SIDNEY**  
p. 96



**LISIO**  
p. 101



**MOUNA**  
p. 102



**NAVEDO**  
p. 106



**NAVEDO**  
p. 110



**LATERNA 5**  
p. 113



**LATERNA 4**  
p. 115

Chapter / Kapitel / Chapitre Spots, Recessed & Function



**FAEDO 1**  
p. 122



**FAEDO 1**  
p. 122



**FAEDO 1**  
p. 122



**FAEDO 1**  
p. 123



**DETECT ME 1**  
p. 128



**DETECT ME 1**  
p. 128



**DETECT ME 2**  
p. 128



**DETECT ME 2**  
p. 128



**DETECT ME 3**  
p. 128



**DETECT ME 3**  
p. 128



**DETECT ME 4**  
p. 129



**DETECT ME 4**  
p. 129



Modern



Übersicht  
 Overview  
 Aperçu

 <b>POLIENTO</b> p. 14	 <b>PENALVA</b> p. 16	 <b>PENALVA 1</b> p. 16	 <b>BASALGO 1</b> p. 18	 <b>TRONO 2</b> p. 20	 <b>TRONO STICK</b> p. 20	 <b>AGOLADA</b> p. 20	 <b>RIGA-LED</b> p. 22
 <b>RIGA-LED</b> p. 23	 <b>RIGA</b> p. 24	 <b>RIGA</b> p. 24	 <b>ASCOLI</b> p. 25	 <b>STOCKHOLM 1</b> p. 25	 <b>CABOS</b> p. 25	 <b>RIGA</b> p. 25	 <b>HELSINKI</b> p. 26
 <b>HELSINKI</b> p. 27	 <b>NISIA</b> p. 28	 <b>OHIO</b> p. 28	 <b>NISIA 1</b> p. 29	 <b>ROFFIA</b> p. 30	 <b>CALGARY</b> p. 31	 <b>KONYA</b> p. 32	 <b>BEVERLY</b> p. 32
 <b>RAVARINO</b> p. 32	 <b>ROBLEDO</b> p. 33	 <b>REDONDO</b> p. 35	 <b>ATOLLARI</b> p. 34	 <b>MORINO</b> p. 34	 <b>SERVOI</b> p. 36	 <b>COVALE</b> p. 36	 <b>BOSARO</b> p. 37
 <b>JORBA</b> p. 38	 <b>PERAFITA</b> p. 39	 <b>SESIMBA</b> p. 40	 <b>SESIMBA 1</b> p. 40	 <b>ONCALA</b> p. 42	 <b>COMIO</b> p. 42	 <b>VOLPINO</b> p. 43	 <b>OROPOS</b> p. 43
 <b>TABO-LED</b> p. 44	 <b>PIAS</b> p. 44	 <b>PARDELA 1</b> p. 44	 <b>CALGARY 1</b> p. 44	 <b>SITIA</b> p. 45	 <b>TABO</b> p. 46	 <b>ZAMORANA</b> p. 46	 <b>ACATE</b> p. 47
 <b>KIBEBA</b> p. 48	 <b>SOJO</b> p. 48	 <b>NADELA</b> p. 48	 <b>PREDAZZO</b> p. 48	 <b>PARK</b> p. 50	 <b>PARK</b> p. 50	 <b>MALGERA</b> p. 50	 <b>BREGANZO</b> p. 50

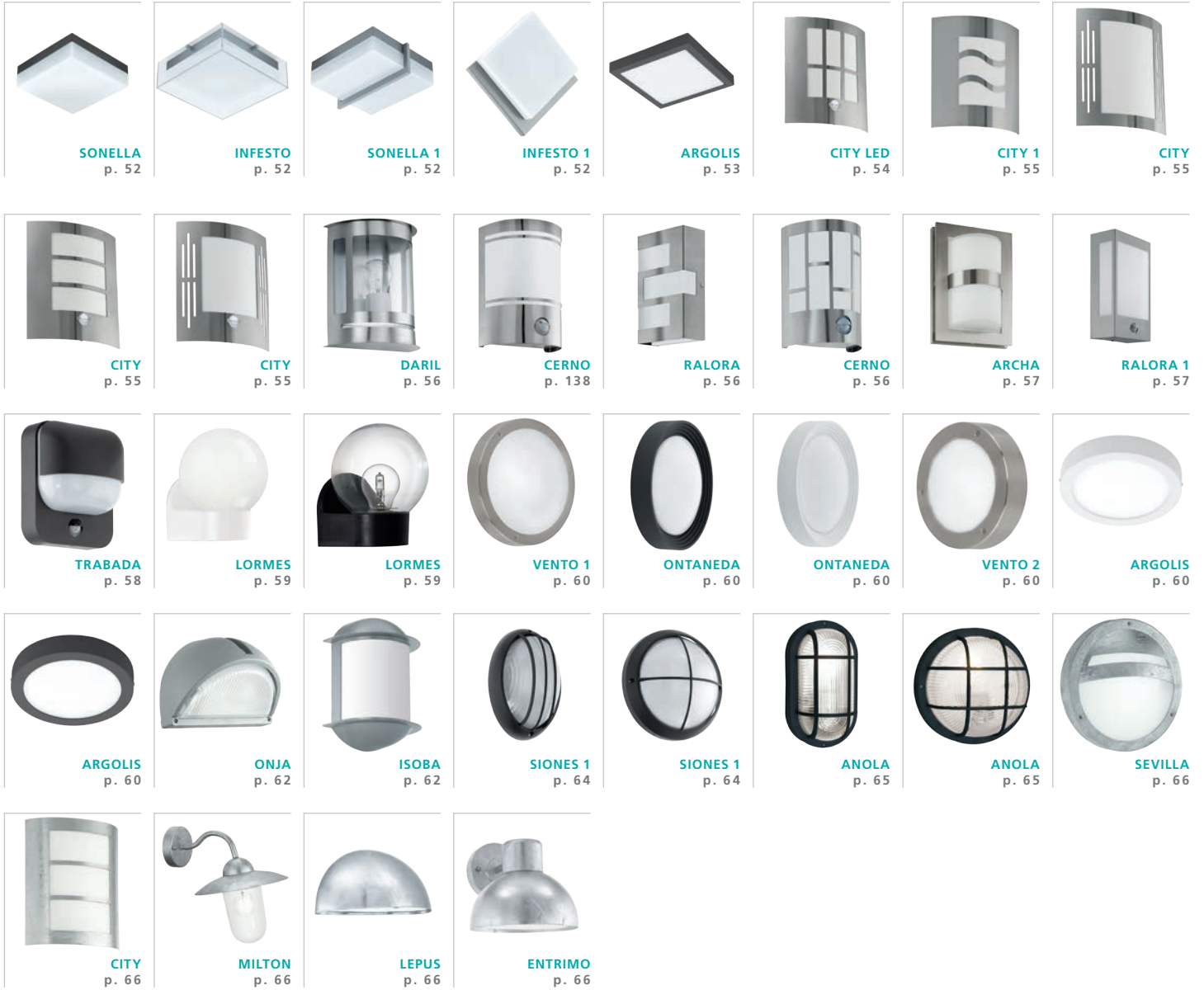



### 95019 POLIENTO

floor luminaire; stainless steel, stainless steel / glass, clear, white  
 Stehleuchte; Edelstahl, edelstahl / Glas, klar, weiss  
 lampadaire; acier inoxydable, acier inoxydable / verre, clair, blanc

H 1000, Ø 150, Base: Ø 115

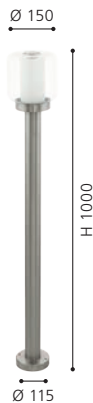

9 002759 950194



### 95016 POLIENTO

wall luminaire; stainless steel, stainless steel / glass, clear, white  
 Wandleuchte; Edelstahl, edelstahl / Glas, klar, weiss  
 applique; acier inoxydable, acier inoxydable / verre, clair, blanc

L 150, H 325, A 195



9 002759 950163



### 95017 POLIENTO

wall luminaire; stainless steel, stainless steel / glass, clear, white  
 Wandleuchte; Edelstahl, edelstahl / Glas, klar, weiss  
 applique; acier inoxydable, acier inoxydable / verre, clair, blanc

L 150, H 325, A 195



9 002759 950170



### 95018 POLIENTO

pedestal luminaire; stainless steel, stainless steel / glass, clear, white  
 Sockelleuchte; Edelstahl, edelstahl / Glas, klar, weiss  
 borne; acier inoxydable, acier inoxydable / verre, clair, blanc

H 500, Ø 150, Base: Ø 115



9 002759 950187





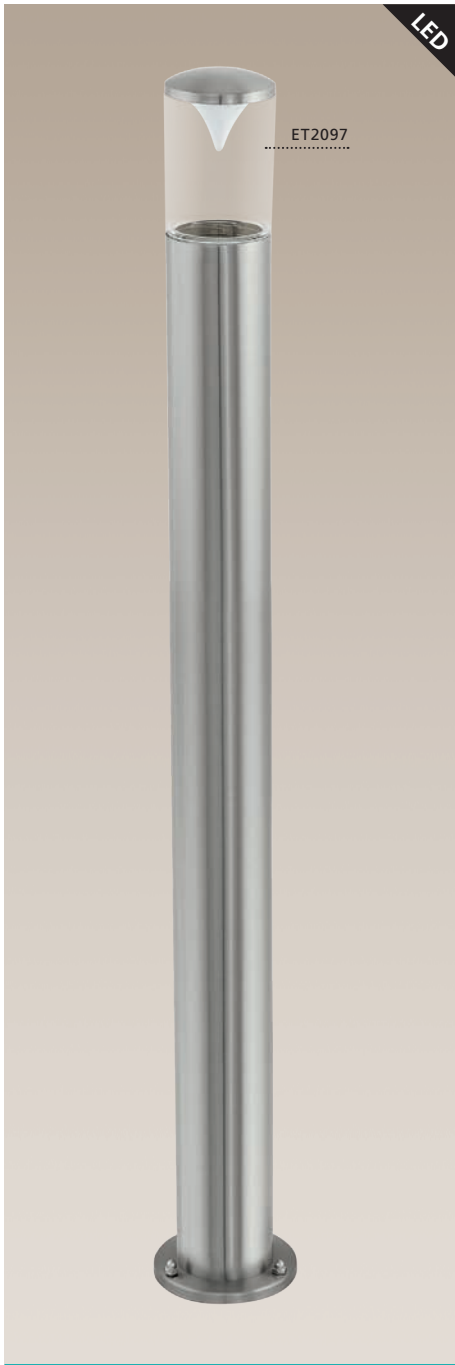

### 94813 PENALVA

floor luminaire; stainless steel, stainless steel / plastic, clear, white  
 Stehleuchte; Edelstahl, edelstahl / Kunststoff, klar, weiss  
 lampadaire; acier inoxydable, acier inoxydable / plastique, clair, blanc

L 75, H 995, Base: Ø 115

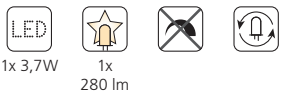

9 002759 948139



### 94811 PENALVA

wall luminaire; stainless steel, stainless steel / plastic, clear, white  
 Wandleuchte; Edelstahl, edelstahl / Kunststoff, klar, weiss  
 applique; acier inoxydable, acier inoxydable / plastique, clair, blanc

L 75, H 225, A 110



9 002759 948115



### 94817 PENALVA 1

wall luminaire; galvanized steel, black / plastic, gold  
 Wandleuchte; Stahl verzinkt, schwarz / Kunststoff, klar, gold  
 applique; acier galvanisé, noir / plastique, gold

L 75, H 225, A 110



9 002759 948177



### 94812 PENALVA

wall luminaire; stainless steel, stainless steel / plastic, clear, white  
 Wandleuchte; Edelstahl, edelstahl / Kunststoff, klar, weiss  
 applique; acier inoxydable, acier inoxydable / plastique, clair, blanc

L 75, H 335, A 110



9 002759 948122



### 94818 PENALVA 1

wall luminaire; galvanized steel, black / plastic, gold  
 Wandleuchte; Stahl verzinkt, schwarz / Kunststoff, klar, gold  
 applique; acier galvanisé, noir / plastique, gold

L 75, H 335, A 110

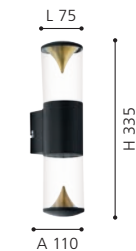

9 002759 948184





### 94819 PENALVA 1

floor luminaire; galvanized steel, black / plastic, gold  
 Stehleuchte; Stahl verzinkt, schwarz / Kunststoff, klar, gold  
 lampadaire; acier galvanisé, noir / plastique, gold

L 75, H 995, Base: Ø 115



1x 3,7W



1x 280 lm



IP44



9 002759 948191

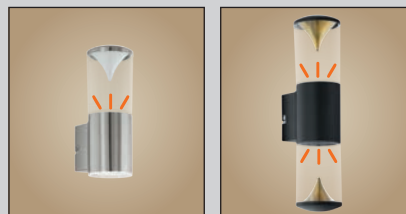

With direct and/or indirect light this luminaire create a spectacular effect.

Diese Leuchten schaffen durch direktes und / oder indirektes Licht einen tollen Effekt.

Ce luminaire crée un effets lumineux special pour une illumination direct et/ou indirect.



### 94277 BASALGO 1

wall luminaire; stainless steel, stainless steel / plastic, clear, white

Wandleuchte; Edelstahl, edelstahl / Kunststoff, klar, weiss

applique; acier inoxydable, acier inoxydable / plastique, clair, blanc

L 105, H 180, A 210



9 002759 942779

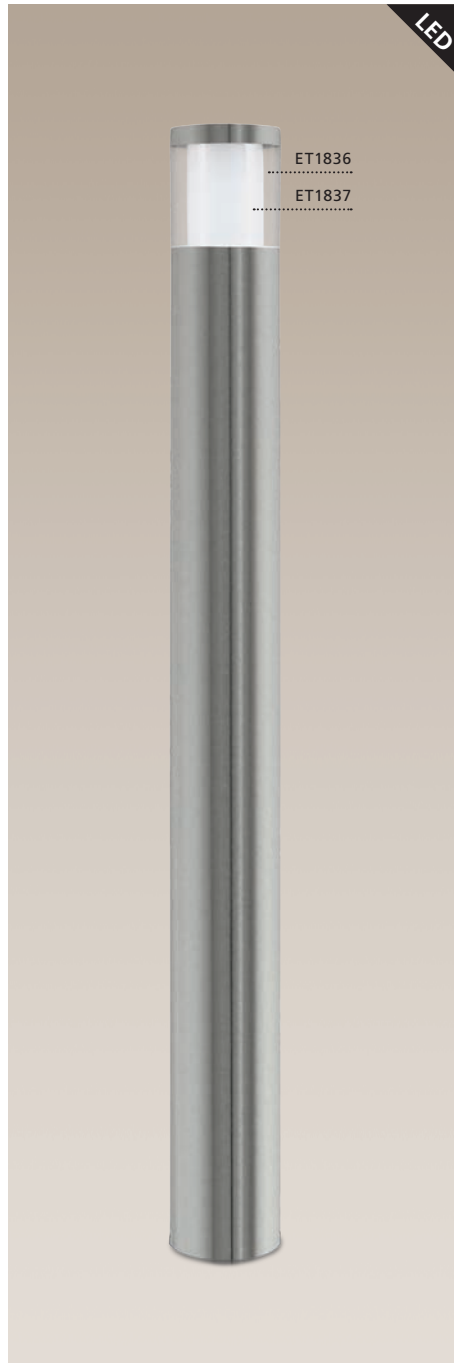

### 94279 BASALGO 1

floor luminaire; stainless steel, stainless steel / plastic, clear, white

Stehleuchte; Edelstahl, edelstahl / Kunststoff, klar, weiss

lampadaire; acier inoxydable, acier inoxydable / plastique, clair, blanc

H 1050, Ø 105

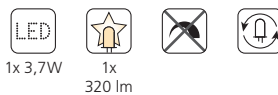

9 002759 942793

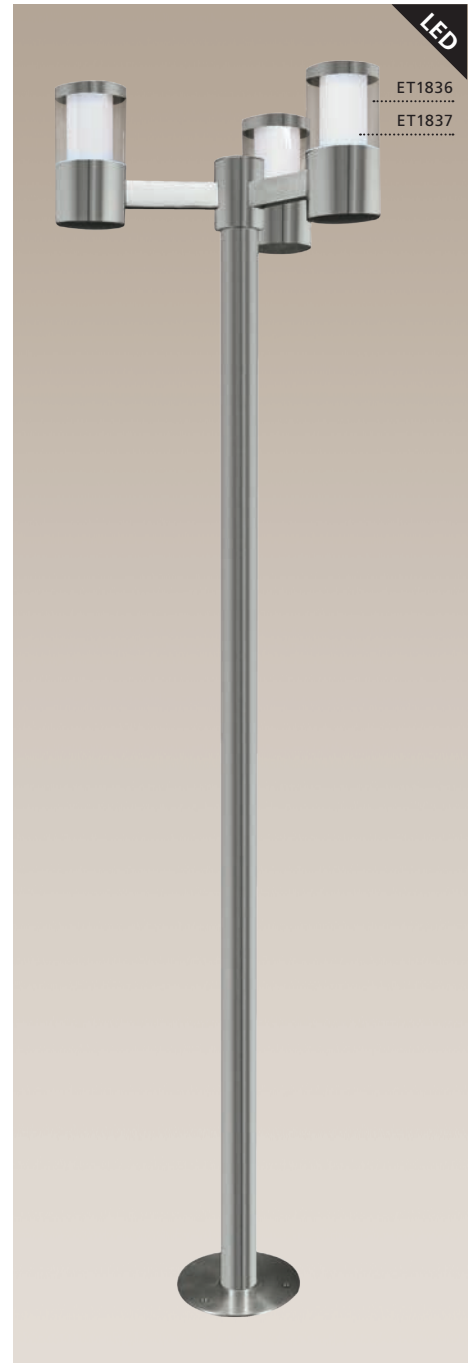
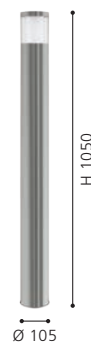

### 94281 BASALGO 1

floor luminaire; stainless steel, stainless steel / plastic, clear, white

Stehleuchte; Edelstahl, edelstahl / Kunststoff, klar, weiss

lampadaire; acier inoxydable, acier inoxydable / plastique, clair, blanc

H 1900, Ø 490

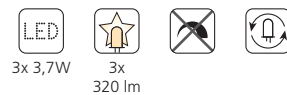

9 002759 942816

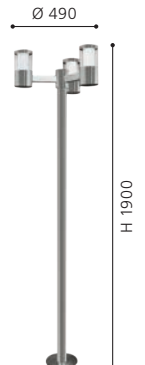





### 94125 TRONO 2

wall luminaire; stainless steel, stainless steel / glass, crystal, clear  
Wandleuchte; Edelstahl, edelstahl / Glas, Kristall, klar  
applique; acier inoxydable, acier inoxydable / verre, cristal, clair

L 105, H 350, A 115

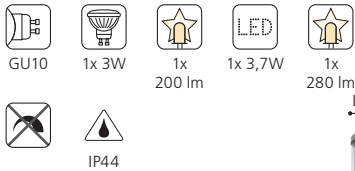

### 94127 TRONO STICK

wall luminaire; stainless steel, stainless steel / glass, plastic, clear  
Wandleuchte; Edelstahl, edelstahl / Glas, Kunststoff, klar  
applique; acier inoxydable, acier inoxydable / verre, plastique, clair

L 105, H 350, A 115

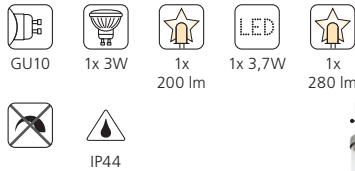

### 94128 TRONO STICK

wall luminaire; stainless steel, stainless steel / glass, plastic, clear  
Wandleuchte; Edelstahl, edelstahl / Glas, Kunststoff, klar  
applique; acier inoxydable, acier inoxydable / verre, plastique, clair

L 105, H 410, A 175

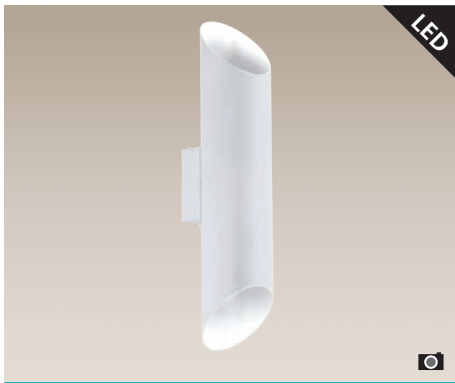

### 94802 AGOLADA

wall luminaire; galvanized steel, white  
Wandleuchte; Stahl verzinkt, weiss  
applique; acier galvanisé, blanc

L 75, H 360, A 110

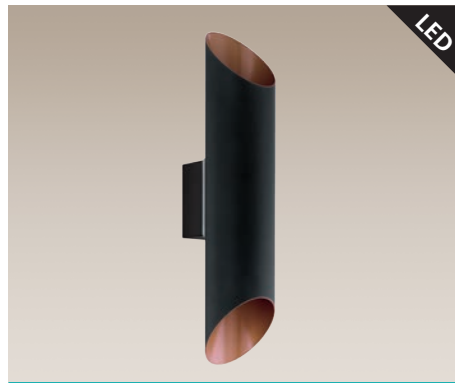

### 94804 AGOLADA

wall luminaire; galvanized steel, black, copper  
Wandleuchte; Stahl verzinkt, schwarz, kupfer  
applique; acier galvanisé, noir, cuivré

L 75, H 360, A 110

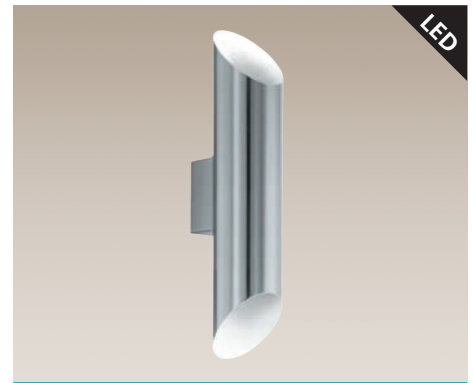

### 94803 AGOLADA

wall luminaire; stainless steel, stainless-steel, white  
Wandleuchte; Edelstahl, edelstahl, weiss  
applique; acier inoxydable, stainless-steel, white

L 75, H 360, A 110

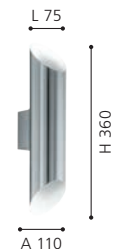





### 92735 RIGA-LED

wall luminaire; stainless steel, stainless steel / plastic, satiné  
Wandleuchte; Edelstahl, edelstahl / Kunststoff, satiniert  
applique; acier inoxydable, acier inoxydable / plastique, satiné

L 65, H 160, A 95



### 92736 RIGA-LED

wall luminaire; stainless steel, stainless steel / plastic, satiné  
Wandleuchte; Edelstahl, edelstahl / Kunststoff, satiniert  
applique; acier inoxydable, acier inoxydable / plastique, satiné

L 65, H 205, A 95

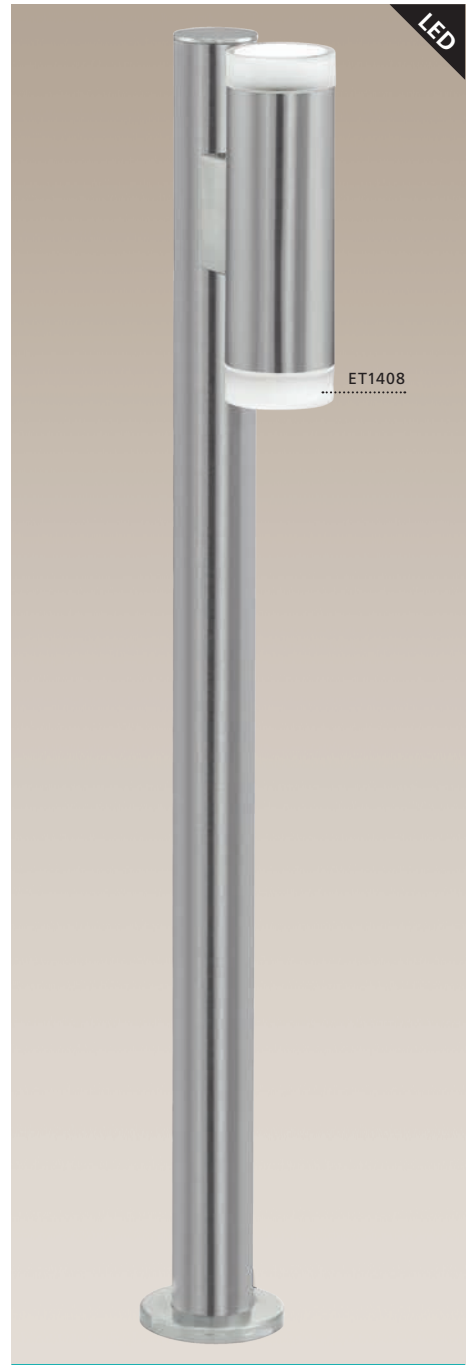
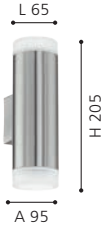
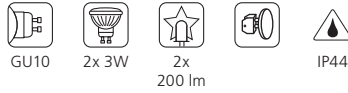

### 92738 RIGA-LED

floor luminaire; stainless steel, stainless steel / plastic, satiné  
Stehleuchte; Edelstahl, edelstahl / Kunststoff, satiniert  
lampadaire; acier inoxydable, acier inoxydable / plastique, satiné

L 130, B 65, H 805, Base: Ø 90

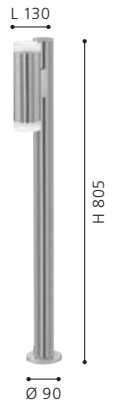
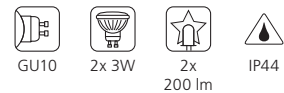

### 92737 RIGA-LED

floor luminaire; stainless steel, stainless steel / plastic, satiné  
Stehleuchte; Edelstahl, edelstahl / Kunststoff, satiniert  
lampadaire; acier inoxydable, acier inoxydable / plastique, satiné

L 130, B 65, H 355, Base: Ø 90

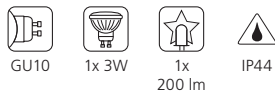



### 96505 RIGA-LED

wall luminaire; galvanized steel, black / plastic, satiné  
 Wandleuchte; Stahl verzinkt, schwarz / Kunststoff, satiniert  
 applique; acier galvanisé, noir / plastique, satiné

L 65, H 205, A 100



GU10



2x 5W



2x  
400 lm



IP44



9 002759 965051



WARM  
WHITE



### 96504 RIGA-LED

wall luminaire; galvanized steel, white / plastic, satiné  
 Wandleuchte; Stahl verzinkt, weiss / Kunststoff, satiniert  
 applique; acier galvanisé, blanc / plastique, satiné

L 65, H 205, A 100



GU10



2x 5W



2x  
400 lm



IP44



9 002759 965044



WARM  
WHITE





### 94105 RIGA

wall luminaire; galvanized steel, antique brown  
Wandleuchte; Stahl verzinkt, antik-braun  
applique; acier galvanisé, marron antique

L 65, H 200, A 95



### 94103 RIGA

wall luminaire; galvanized steel, anthracite  
Wandleuchte; Stahl verzinkt, anthrazit  
applique; acier galvanisé, anthracite

L 65, H 200, A 95



### 94101 RIGA

wall luminaire; galvanized steel, white  
Wandleuchte; Stahl verzinkt, weiss  
applique; acier galvanisé, blanc

L 65, H 200, A 95



### 94104 RIGA

wall luminaire; galvanized steel, antique brown  
Wandleuchte; Stahl verzinkt, antik-braun  
applique; acier galvanisé, marron antique

L 65, H 150, A 95



### 94102 RIGA

wall luminaire; galvanized steel, anthracite  
Wandleuchte; Stahl verzinkt, anthrazit  
applique; acier galvanisé, anthracite

L 65, H 150, A 95



### 94099 RIGA

wall luminaire; galvanized steel, white  
Wandleuchte; Stahl verzinkt, weiss  
applique; acier galvanisé, blanc

L 65, H 150, A 95



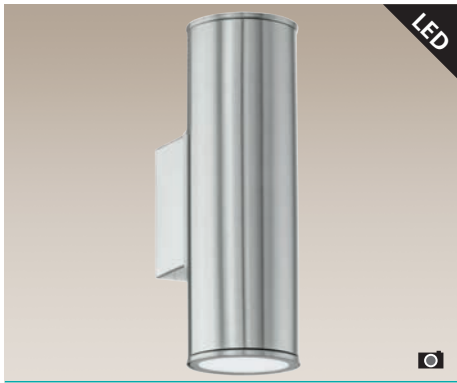

### 94107 RIGA

wall luminaire; stainless steel, stainless steel  
Wandleuchte; Edelstahl, edelstahl  
applique; acier inoxydable, acier inoxydable

L 65, H 200, A 95



### 94106 RIGA

wall luminaire; stainless steel, stainless steel  
Wandleuchte; Edelstahl, edelstahl  
applique; acier inoxydable, acier inoxydable

L 65, H 150, A 95



### 90121 ASCOLI

wall luminaire; stainless steel, stainless steel / glass, clear  
Wandleuchte; Edelstahl, edelstahl / Glas, klar  
applique; acier inoxydable, acier inoxydable / verre, clair

L 125, H 325, A 160

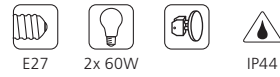

### 93271 CABOS

wall luminaire; stainless steel, stainless steel / glass, satined  
Wandleuchte; Edelstahl, edelstahl / Glas, satiniert  
applique; acier inoxydable, acier inoxydable / verre, satiné

L 75, H 210, A 90



### 93268 STOCKHOLM 1

wall luminaire; stainless steel, stainless steel / glass, clear  
Wandleuchte; Edelstahl, edelstahl / Glas, klar  
applique; acier inoxydable, acier inoxydable / verre, clair

Ø 65

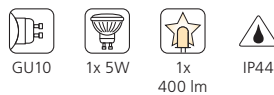

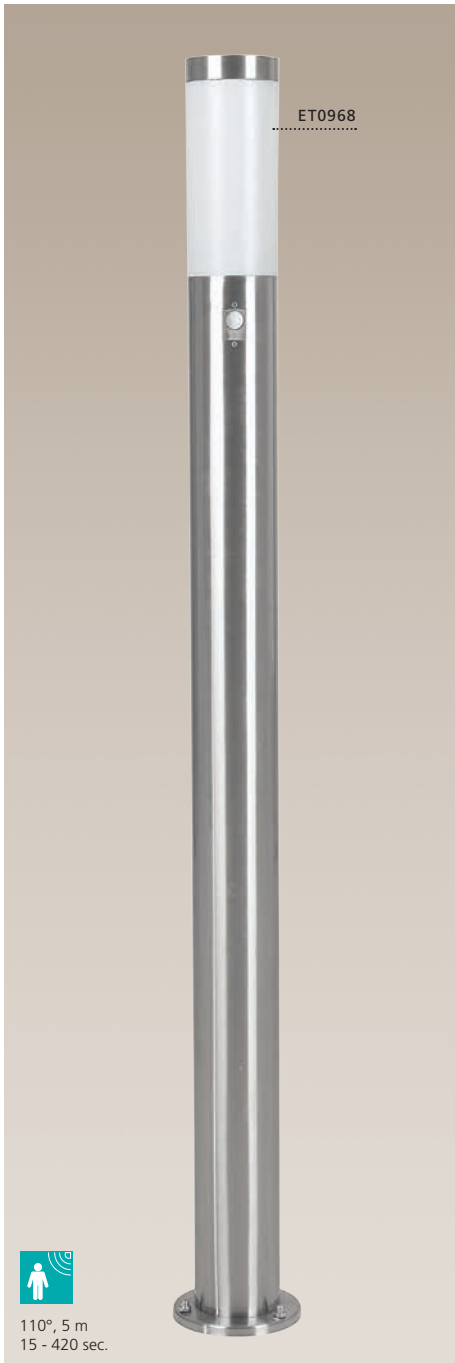

110°, 5 m  
15 - 420 sec.

### 83281 HELSINKI

floor luminaire; stainless steel, stainless steel / plastic, white  
Stehleuchte; Edelstahl, edelstahl / Kunststoff, weiss  
lampadaire; acier inoxydable, acier inoxydable / plastique, blanc

H 1100, Ø 75, Base: Ø 115

E27 1x 15W IP44

9 002759 832810

A++-B



### 81752 HELSINKI

floor luminaire; stainless steel, stainless steel / plastic, white  
Stehleuchte; Edelstahl, edelstahl / Kunststoff, weiss  
lampadaire; acier inoxydable, acier inoxydable / plastique, blanc

H 1100, Ø 75, Base: Ø 115

E27 1x 15W IP44

9 002759 817527

A++-B



110°, 5 m  
15 - 420 sec.

### 83279 HELSINKI

floor luminaire; stainless steel, stainless steel / plastic, white  
Stehleuchte; Edelstahl, edelstahl / Kunststoff, weiss  
lampadaire; acier inoxydable, acier inoxydable / plastique, blanc

H 450, Ø 75, Base: Ø 115

E27 1x 15W IP44



A++-B

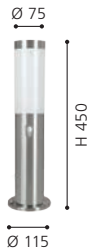

### 81751 HELSINKI

floor luminaire; stainless steel, stainless steel / plastic, white  
Stehleuchte; Edelstahl, edelstahl / Kunststoff, weiss  
lampadaire; acier inoxydable, acier inoxydable / plastique, blanc

H 450, Ø 75, Base: Ø 115

E27 1x 15W IP44

9 002759 817510

A++-B

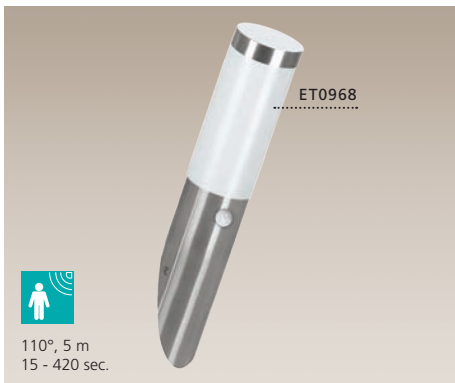

### 83278 HELSINKI

wall luminaire; stainless steel, stainless steel / plastic, white  
 Wandleuchte; Edelstahl, edelstahl / Kunststoff, weiss  
 applique; acier inoxydable, acier inoxydable / plastique, blanc

H 425, Ø 75, A 165



E27



1x 15W



IP44

Ø 75



H 425

A 165



9 002759 832780



A++-B



### 81753 HELSINKI

wall luminaire; stainless steel, stainless steel / plastic, white  
 Wandleuchte; Edelstahl, edelstahl / Kunststoff, weiss  
 applique; acier inoxydable, acier inoxydable / plastique, blanc

H 390, Ø 75, A 165



E27



1x 15W



IP44

Ø 75



H 390

A 165



9 002759 817534



A++-B





GL2852



GL2852



90°, 8 m  
5 - 240 sec.

### 27126 NISIA

wall luminaire; stainless steel, stainless steel / glass, white

Wandleuchte; Edelstahl, edelstahl / Glas, weiss

applique; acier inoxydable, acier inoxydable / verre, blanc

H 343, Ø 200



E27



1x 60W



IP44



9 002759 271268



GL2852

### 30206 NISIA

floor luminaire; stainless steel, stainless steel / satinated glass, white

Stehleuchte; Edelstahl, edelstahl / Glas satiniert, weiss

lampadaire; acier inoxydable, acier inoxydable / verre satiné, blanc

H 500, Ø 200, Base: Ø 130



E27



1x 60W



IP44



9 002759 302061

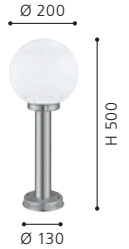

GL2852

### 30205 NISIA

wall luminaire; stainless steel, stainless steel / satinated glass, white

Wandleuchte; Edelstahl, edelstahl / Glas satiniert, weiss

applique; acier inoxydable, acier inoxydable / verre satiné, blanc

L 200, H 360, A 240



E27



1x 60W



IP44



9 002759 302054

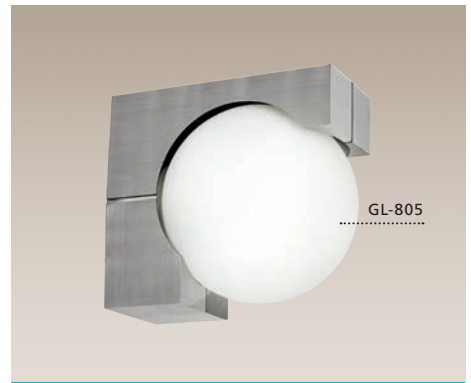

GL-805

### 89314 OHIO

wall luminaire; cast aluminium, stainless steel / opal glass, white

Wandleuchte; Aluguss, edelstahl / Glas opal-matt, weiss

applique; aluminium moulé, acier inoxydable / verre opale, blanc

L 190, H 215, A 235



E27



1x 60W



IP54



9 002759 893149

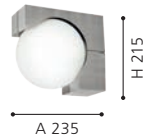

### 30207 NISIA

floor luminaire; stainless steel, stainless steel / satinated glass, white

Stehleuchte; Edelstahl, edelstahl / Glas satiniert, weiss

lampadaire; acier inoxydable, acier inoxydable / verre satiné, blanc

H 1000, Ø 200



E27



1x 60W



IP44



9 002759 302078

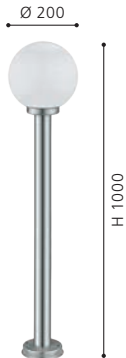



GL2968

### 93366 NISIA 1

wall luminaire; stainless steel, stainless steel / glass with wires, clear, aluminium

Wandleuchte; Edelstahl, edelstahl / Glas mit Draht, klar, alu

applique; acier inoxydable, acier inoxydable / verre avec fil, clair, aluminium

H 360, Ø 200, A 240



E27



1x 60W



IP44



9 002759 933661



A++-E

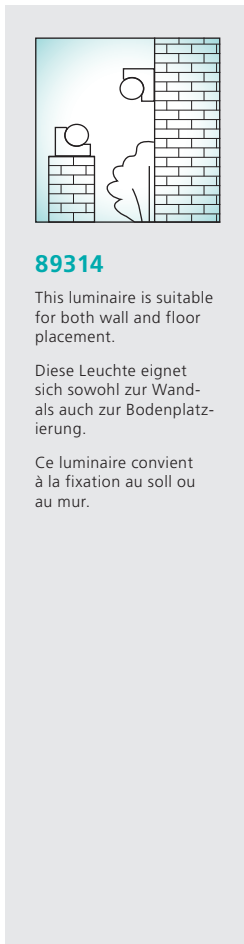

### 89314

This luminaire is suitable for both wall and floor placement.

Diese Leuchte eignet sich sowohl zur Wand- als auch zur Bodenplatzierung.

Ce luminaire convient à la fixation au sol ou au mur.



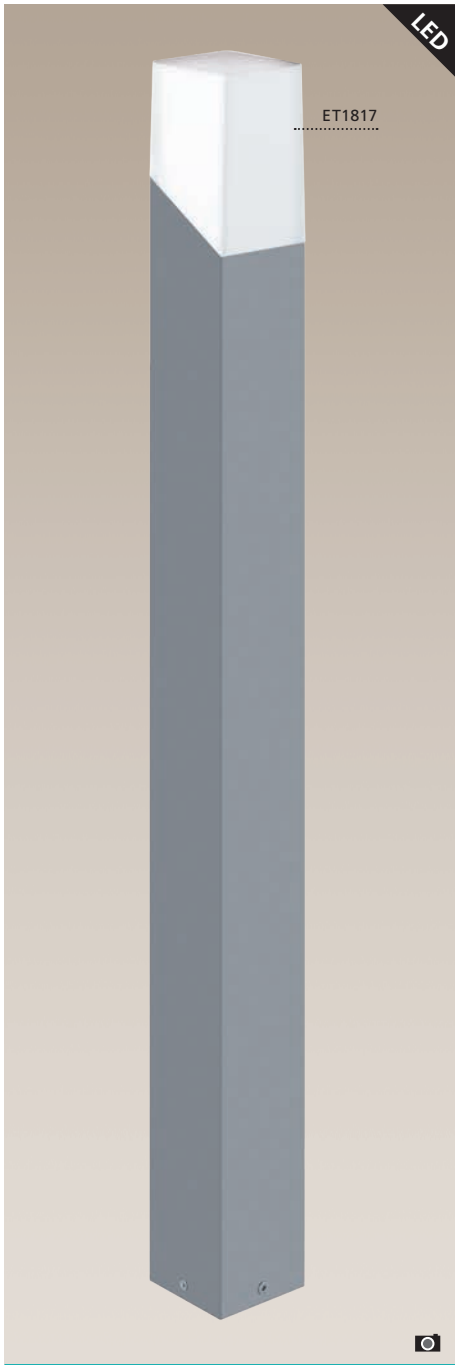

**94088 ROFFIA**

floor luminaire; aluminium, silver / plastic, white  
 Stehleuchte; Alu, silber / Kunststoff, weiss  
 lampadaire; aluminium, argent / plastique, blanc

L 90, B 90, H 1000



9 002759 940881

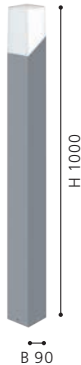

**94087 ROFFIA**

wall luminaire; aluminium, silver / plastic, white  
 Wandleuchte; Alu, silber / Kunststoff, weiss  
 applique; aluminium, argent / plastique, blanc

L 90, H 210, A 120



9 002759 940874

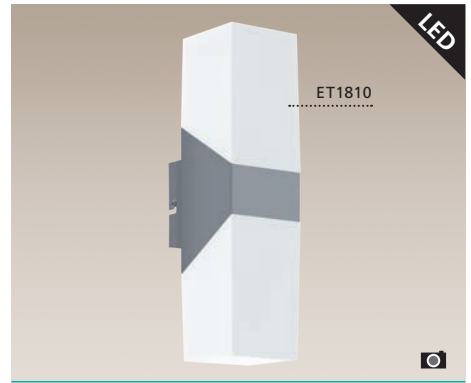

**94118 ROFFIA**

wall luminaire; aluminium, silver / plastic, white  
 Wandleuchte; Alu, silber / Kunststoff, weiss  
 applique; aluminium, argent / plastique, blanc

L 90, H 340, A 120



9 002759 941185

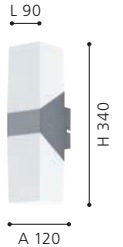



### 86389 CALGARY

floor luminaire; stainless steel, stainless steel / opal glass, white  
 Stehleuchte; Edelstahl, edelstahl / Glas opal-matt, weiss  
 lampadaire; acier inoxydable, acier inoxydable / verre opale, blanc

L 100, B 100, H 1100, Base: B 90, T 90



E27

1x 60W

IP44

B 100



H 1100



9 002759 863890



### 86388 CALGARY

floor luminaire; stainless steel, stainless steel / opal glass, white  
 Stehleuchte; Edelstahl, edelstahl / Glas opal-matt, weiss  
 lampadaire; acier inoxydable, acier inoxydable / verre opale, blanc

L 100, B 100, H 435, Base: B 90, T 90



E27

1x 60W

IP44

B 100



H 435



9 002759 863883



### 86387 CALGARY

wall luminaire; stainless steel, stainless steel / opal glass, white  
 Wandleuchte; Edelstahl, edelstahl / Glas opal-matt, weiss  
 applique; acier inoxydable, acier inoxydable / verre opale, blanc

L 100, H 270, A 120, Base: B 90, T 90



E27

1x 60W

IP44

L 100



H 270



9 002759 863876





### 86541 BEVERLY

wall luminaire; stainless steel, stainless steel, silver / satinated glass, white

Wandleuchte; Edelstahl, edelstahl, silber / Glas satiniert, weiss

applique; acier inoxydable, acier inoxydable, argent / verre satiné, blanc

L 200, H 350, A 135



### 94119 RAVARINO

wall luminaire; aluminium, silver / plastic, white

Wandleuchte; Alu, silber / Kunststoff, weiss

applique; aluminium, argent / plastique, blanc

L 140, H 270, A 110



### 86385 KONYA

wall luminaire; stainless steel, stainless steel / satinated glass, white

Wandleuchte; Edelstahl, edelstahl / Glas satiniert, weiss

applique; acier inoxydable, acier inoxydable / verre satiné, blanc

L 80, H 215, A 120

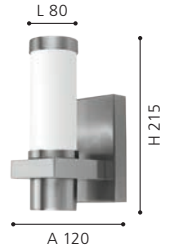
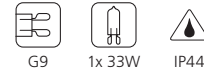

### 86248 KONYA

pedestal luminaire; stainless steel, stainless steel / satinated glass, white

Sockelleuchte; Edelstahl, edelstahl / Glas satiniert, weiss

borne; acier inoxydable, acier inoxydable / verre satiné, blanc

H 350, Base: Ø 90

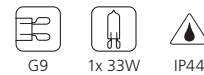



### 96014 ROBLEDO

wall luminaire; galvanized steel, anthracite / plastic, transparent  
 Wandleuchte; Stahl verzinkt, anthrazit / Kunststoff, transparent  
 applique; acier galvanisé, anthracite / plastique, transparent

L 75, H 260, A 120



2x 3,7W



2x  
320 lm



IP44



9 002759 960148



L 75



H 260

A 120



### 96013 ROBLEDO

wall luminaire; stainless steel, stainless steel /  
 plastic, transparent

Wandleuchte; Edelstahl, edelstahl /  
 Kunststoff, transparent

applique; acier inoxydable, acier inoxydable /  
 plastique, transparent

L 75, H 260, A 120



2x 3,7W



2x  
320 lm



IP44



9 002759 960131



L 75



H 260

A 120





### 93319 MORINO

wall luminaire; cast aluminium, anthracite  
Wandleuchte; Aluguss, anthrazit  
applique; aluminium moulé, anthracite

L 140, H 180, A 105

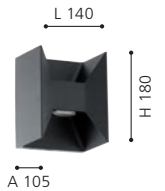

### 96276 ATOLLARI

wall luminaire; cast aluminium, anthracite / plastic, white

Wandleuchte; Aluguss, anthrazit / Kunststoff, weiss

applique; aluminium moulé, anthracite / plastique, blanc

L 100, H 230, A 155



### 96277 ATOLLARI

wall luminaire; cast aluminium, stainless steel, silver / plastic, white

Wandleuchte; Aluguss, edelstahl, silber / Kunststoff, weiss

applique; aluminium moulé, acier inoxydable, argent / plastique, blanc

L 100, H 230, A 155

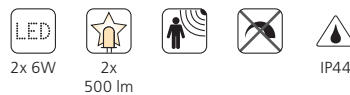

### 93318 MORINO

wall luminaire; cast aluminium, white

Wandleuchte; Aluguss, weiss

applique; aluminium moulé, blanc

L 140, H 180, A 105

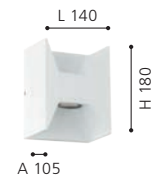



### 93367 REDONDO

wall luminaire; cast aluminium, white  
 Wandleuchte; Aluguss, weiss  
 applique; aluminium moulé, blanc

L 160, H 175, A 125



2x 2,5W



2x  
180 lm



IP44



9 002759 933678



WARM  
WHITE



### 93368 REDONDO

wall luminaire; cast aluminium, anthracite  
 Wandleuchte; Aluguss, anthrazit  
 applique; aluminium moulé, anthracite

L 160, H 175, A 125



2x 2,5W



2x  
180 lm



IP44



9 002759 933685



WARM  
WHITE





### 95992 SERVOI

wall luminaire; galvanized steel, anthracite / plastic, transparent  
Wandleuchte; Stahl verzinkt, anthrazit / Kunststoff, transparent  
applique; acier galvanisé, anthracite / plastique, transparent

L 100, H 250, A 85



### 95991 SERVOI

wall luminaire; galvanized steel, white / plastic, transparent  
Wandleuchte; Stahl verzinkt, weiss / Kunststoff, transparent  
applique; acier galvanisé, blanc / plastique, transparent

L 100, H 250, A 85



### 96015 COVALE

wall luminaire; stainless steel, stainless steel / plastic, white  
Wandleuchte; Edelstahl, edelstahl / Kunststoff, weiss  
applique; acier inoxydable, acier inoxydable / plastique, blanc

L 75, H 285, A 125



### 96016 COVALE

wall luminaire; galvanized steel, anthracite / plastic, white  
Wandleuchte; Stahl verzinkt, anthrazit / Kunststoff, weiss  
applique; acier galvanisé, anthracite / plastique, blanc

L 75, H 285, A 125

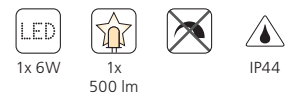



### 93991 BOSARO

wall luminaire; galvanized steel, white  
 Wandleuchte; Stahl verzinkt, weiss  
 applique; acier galvanisé, blanc

L 170, H 270, A 105



2x 2,5W



2x  
180 lm



IP44



9 002759 939915



### 94779 BOSARO

wall luminaire; stainless steel, stainless steel  
 Wandleuchte; Edelstahl, edelstahl  
 applique; acier inoxydable, acier inoxydable

L 170, H 270, A 105



2x 2,5W



2x  
180 lm



IP44



9 002759 947798





### 96256 JORBA

wall luminaire; cast aluminium, anthracite / plastic, white  
Wandleuchte; Aluguss, anthrazit / Kunststoff, weiss  
applique; aluminium moulé, anthracite / plastique, blanc

L 110, H 110, A 110



1x 6W



1x  
500 lm



IP44



9 002759 962562



WARM  
WHITE

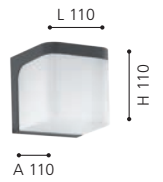

### 96255 JORBA

wall luminaire; cast aluminium, white / plastic, white  
Wandleuchte; Aluguss, weiss / Kunststoff, weiss  
applique; aluminium moulé, blanc / plastique, blanc

L 110, H 110, A 110



1x 6W



1x  
500 lm



IP44



9 002759 962555



WARM  
WHITE

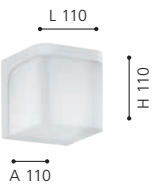



### 96007 PERAFITA

wall luminaire; cast aluminium, anthracite / plastic, white  
Wandleuchte; Aluguss, anthrazit / Kunststoff, weiss  
applique; aluminium moulé, anthracite / plastique, blanc

L 175, H 170, A 95



2x 6W



2x

500 lm



IP44



9 002759 960070



L 175



H 170

A 95



### 96006 PERAFITA

wall luminaire; cast aluminium, white / plastic, white  
Wandleuchte; Aluguss, weiss / Kunststoff, weiss  
applique; aluminium moulé, blanc / plastique, blanc

L 175, H 170, A 95



2x 6W



2x

500 lm



IP44



9 002759 960063



L 175



H 170

A 95



### 94849 SESIMBA

wall luminaire; steel, white / plastic, clear  
Wandleuchte; Stahl, weiss / Kunststoff, klar  
applique; acier, blanc / plastique, clair

L 130, H 195, A 140



### 94848 SESIMBA

wall luminaire; galvanized steel, black / plastic, clear  
Wandleuchte; Stahl verzinkt, schwarz / Kunststoff, klar  
applique; acier galvanisé, noir / plastique, clair

L 130, H 195, A 140



### 94796 SESIMBA

wall luminaire; galvanized steel, silver / plastic, clear  
Wandleuchte; Stahl verzinkt, silber / Kunststoff, klar  
applique; acier galvanisé, argent / plastique, clair

L 130, H 195, A 140

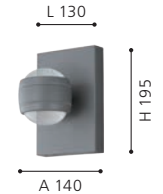

### 96022 SESIMBA 1

wall luminaire; galvanized steel, white / plastic, clear  
Wandleuchte; Stahl verzinkt, weiss / Kunststoff, klar  
applique; acier galvanisé, blanc / plastique, clair

L 130, H 195, A 140



### 96021 SESIMBA 1

wall luminaire; galvanized steel, black / plastic, clear  
Wandleuchte; Stahl verzinkt, schwarz / Kunststoff, klar  
applique; acier galvanisé, noir / plastique, clair

L 130, H 195, A 140



### 96019 SESIMBA 1

wall luminaire; galvanized steel, silver / plastic, clear  
Wandleuchte; Stahl verzinkt, silber / Kunststoff, klar  
applique; acier galvanisé, argent / plastique, clair

L 130, H 195, A 140

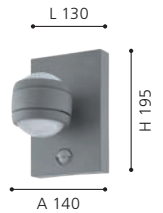



### SESIMBA 1



These lights are equipped with one day and night sensor.

Diese Leuchten sind mit einem Tag und Nacht Sensor ausgestattet.

Ces lumières sont équipées d'un jour et nuit le détecteur.

[see page / siehe Seite / voir page 139](#)



### 95981 ONCALA

wall luminaire; galvanized steel, black / satinated glass, white  
Wandleuchte; Stahl verzinkt, schwarz / Glas satiniert, weiss  
applique; acier galvanisé, noir / verre satiné, blanc

L 150, H 140, A 190



### 95982 ONCALA

wall luminaire; stainless steel, stainless steel / satinated glass, white  
Wandleuchte; Edelstahl, edelstahl / Glas satiniert, weiss  
applique; acier inoxydable, acier inoxydable / verre satiné, blanc

L 150, H 140, A 190



### 95986 COMIO

floor luminaire; galvanized steel, anthracite / plastic, clear  
Stehleuchte; Stahl verzinkt, anthrazit / Kunststoff, klar  
lampadaire; acier galvanisé, anthracite / plastique, clair

B 110, H 1020, Base: Ø 110

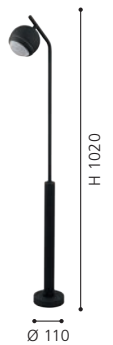

### 95985 COMIO

wall luminaire; galvanized steel, anthracite / plastic, clear  
Wandleuchte; Stahl verzinkt, anthrazit / Kunststoff, klar  
applique; acier galvanisé, anthracite / plastique, clair

Ø 110, A 135





### 91769 VOLPINO

wall luminaire; galvanized steel, silver / plastic, white  
Wandleuchte; Stahl verzinkt, silber / Kunststoff, weiss  
applique; acier galvanisé, argent / plastique, blanc

L 290, H 115, A 60

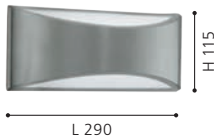
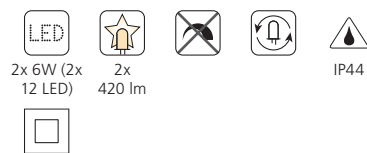

### 96238 OROPOS

wall luminaire; galvanized steel, anthracite / plastic, white  
Wandleuchte; Stahl verzinkt, anthrazit / Kunststoff, weiss  
applique; acier galvanisé, anthracite / plastique, blanc

Ø 250, A 75



### 96237 OROPOS

wall luminaire; galvanized steel, silver / plastic, white  
Wandleuchte; Stahl verzinkt, silber / Kunststoff, weiss  
applique; acier galvanisé, argent / plastique, blanc

Ø 250, A 75



### 96237, 96238

1x A-F      3x 0-9

Letters and numbers included in delivery.  
Buchstaben und Zahlen im Lieferumfang enthalten.  
Les lettres et les nombres sont inclus dans la livraison.



### 93365 PIAS

wall luminaire; stainless steel, stainless steel  
Wandleuchte; Edelstahl, edelstahl  
applique; acier inoxydable, acier inoxydable

L 150, H 250, A 55



### 93364 TABO-LED

wall luminaire; stainless steel, stainless steel  
Wandleuchte; Edelstahl, edelstahl  
applique; acier inoxydable, acier inoxydable

L 80, H 195, A 110



### 94114 CALGARY 1

wall luminaire; stainless steel, stainless steel / plastic, white  
Wandleuchte; Edelstahl, edelstahl / Kunststoff, weiss  
applique; acier inoxydable, acier inoxydable / plastique, blanc

L 200, H 200, A 95

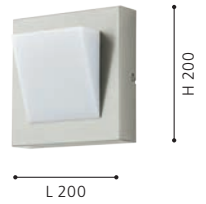

### 93369 PARDELA 1

wall luminaire; stainless steel, stainless steel  
Wandleuchte; Edelstahl, edelstahl  
applique; acier inoxydable, acier inoxydable

L 170, H 280, A 100

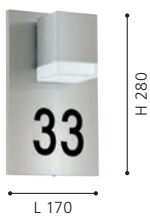

### 93369

1x A-F 3x 0-9

Letters and numbers included in delivery.  
Buchstaben und Zahlen im Lieferumfang enthalten.  
Les lettres et les nombres sont inclus dans la livraison.



### 95988 SITIA

wall luminaire; galvanized steel, anthracite / plastic, white  
 Wandleuchte; Stahl verzinkt, anthrazit / Kunststoff, weiss  
 applique; acier galvanisé, anthracite / plastique, blanc

L 180, H 180, A 55



2x 4,8W



2x  
550 lm



IP44



9 002759 959883

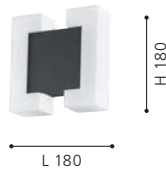

### 95987 SITIA

wall luminaire; galvanized steel, satin nickel / plastic, white  
 Wandleuchte; Stahl verzinkt, nickel-matt / Kunststoff, weiss  
 applique; acier galvanisé, nickel mat / plastique, blanc

L 180, H 180, A 55



2x 4,8W



2x  
550 lm



IP44



9 002759 959876

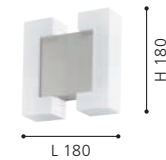



### 94793 ZAMORANA

wall luminaire; stainless steel, stainless steel  
Wandleuchte; Edelstahl, edelstahl  
applique; acier inoxydable, acier inoxydable

L 65, H 165, A 65

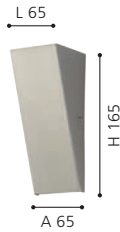

### 94794 ZAMORANA

wall luminaire; stainless steel, stainless steel  
Wandleuchte; Edelstahl, edelstahl  
applique; acier inoxydable, acier inoxydable

L 95, H 215, A 95

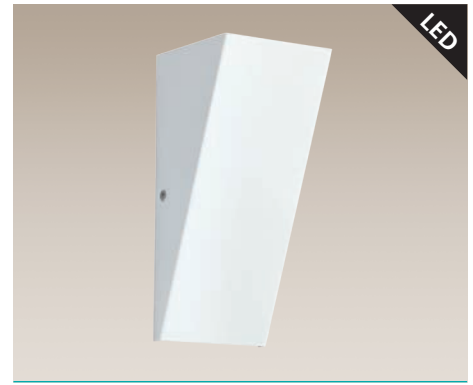

### 94851 ZAMORANA

wall luminaire; galvanized steel, white  
Wandleuchte; Stahl verzinkt, weiss  
applique; acier galvanisé, blanc

L 95, H 215, A 95

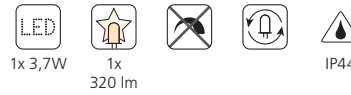

### 94184 TABO

ceiling luminaire; aluminium, silver  
Deckenleuchte; Alu, silber  
plafonnier; aluminium, argent

L 75, B 75, H 80

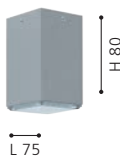
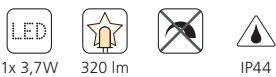

### 94185 TABO

wall luminaire; aluminium, silver  
Wandleuchte; Alu, silber  
applique; aluminium, argent

L 75, B 75, H 140, A 105

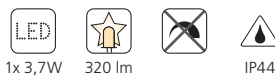

### 94186 TABO

wall luminaire; aluminium, silver  
Wandleuchte; Alu, silber  
applique; aluminium, argent

L 75, B 75, H 195, A 105

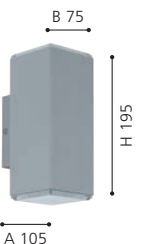
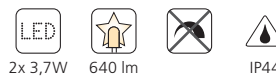

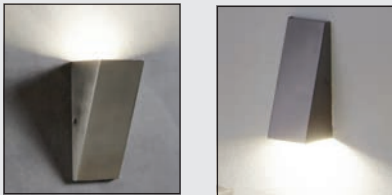

### ZAMORANO

This luminaire is suitable for up- and downward placement.

Diese Leuchte kann sowohl nach oben als auch nach unten strahlend montiert werden.

Ce luminaire peut être installé vers le haut ou vers le bas, selon l'effet lumineux désiré.



### 94845 ACATE

wall / ceiling luminaire; aluminium, steel, silver / plastic, white  
Wand- / Deckenleuchte; Alu, Stahl, silber / Kunststoff, weiss  
applique / plafonnier; aluminium, acier, argent / plastique, blanc

L 100, H 350, A 60



8W



770 lm



IP44



9 002759 948450

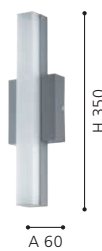



### 93256 SOJO

wall luminaire; galvanized steel, white  
Wandleuchte; Stahl verzinkt, weiss  
applique; acier galvanisé, blanc

L 180, H 265, A 135

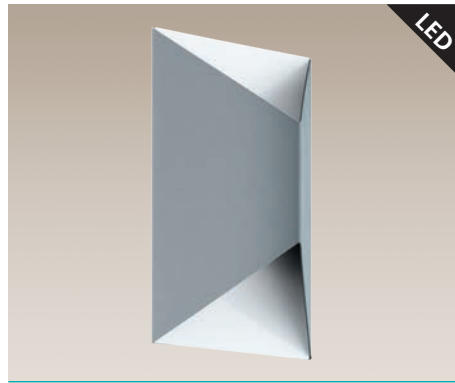

### 93993 PREDAZZO

wall luminaire; galvanized steel, silver, white  
Wandleuchte; Stahl verzinkt, silber, weiss  
applique; acier galvanisé, argent, blanc

L 140, H 210, A 75

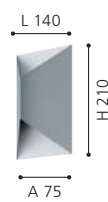

### 93994 PREDAZZO

wall luminaire; galvanized steel, anthracite, white  
Wandleuchte; Stahl verzinkt, anthrazit, weiss  
applique; acier galvanisé

L 140, H 210, A 75

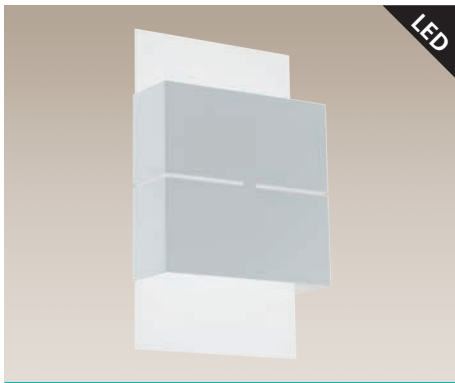

### 93253 KIBEA

wall luminaire; galvanized steel, white  
Wandleuchte; Stahl verzinkt, weiss  
applique; acier galvanisé, blanc

L 150, H 260, A 75



### 93254 KIBEA

wall luminaire; galvanized steel, white, anthracite  
Wandleuchte; Stahl verzinkt, weiss, anthrazit  
applique; acier galvanisé, blanc, anthracite

L 150, H 260, A 75



### 93438 NADELA

wall luminaire; stainless steel, stainless steel / satinated glass, white  
Wandleuchte; Edelstahl, edelstahl / Glas satiniert, weiss  
applique; acier inoxydable, acier inoxydable / verre satiné, blanc

L 215, H 290, A 90







### 94138 BREGANZO

wall luminaire; galvanized steel, anthracite / plastic, white  
Wandleuchte; Stahl verzinkt, anthrazit / Kunststoff, weiss  
applique; acier galvanisé, anthracite / plastique, blanc

### 94137 BREGANZO

wall luminaire; galvanized steel, silver / plastic, white  
Wandleuchte; Stahl verzinkt, silber / Kunststoff, weiss  
applique; acier galvanisé, argent / plastique, blanc

### 94133 MALGERA

wall luminaire; galvanized steel, silver / plastic, white  
Wandleuchte; Stahl verzinkt, silber / Kunststoff, weiss  
applique; acier galvanisé, argent / plastique, blanc

L 180, H 250, A 115



L 180, H 250, A 115



L 170, H 270, A 115



### 83433 PARK

wall luminaire; cast aluminium, anthracite / satinated glass, white  
Wandleuchte; Aluguss, anthrazit / Glas satiniert, weiss  
applique; aluminium moulé, anthracite / verre satiné, blanc

L 200, H 350, A 145

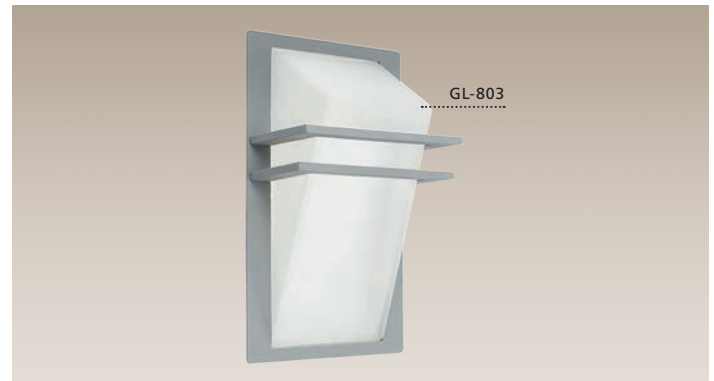

### 83432 PARK

wall luminaire; cast aluminium, silver / satinated glass, white  
Wandleuchte; Aluguss, silber / Glas satiniert, weiss  
applique; aluminium moulé, argent / verre satiné, blanc

L 200, H 350, A 145





### 96018 BREGANZO 1

wall luminaire; galvanized steel, anthracite / plastic, white  
 Wandleuchte; Stahl verzinkt, anthrazit / Kunststoff, weiss  
 applique; acier galvanisé, anthracite / plastique, blanc

L 190, H 300, A 125



2x 2,5W



2x  
180 lm



IP44



### 96017 BREGANZO 1

wall luminaire; galvanized steel, silver / plastic, white  
 Wandleuchte; Stahl verzinkt, silber / Kunststoff, weiss  
 applique; acier galvanisé, argent / plastique, blanc

L 190, H 300, A 125



2x 2,5W



2x  
180 lm



IP44



### 96018 & 96017



These lights are equipped with day and night sensor.

Diese Leuchten sind mit einem Tag und Nacht Sensor ausgestattet.

Ces lumières sont équipées d'un jour et nuit le détecteur.

see page / siehe Seite / voir page 139



### 94871 SONELLA

wall / ceiling luminaire; plastic, white / plastic, white

Wand- / Deckenleuchte; Kunststoff, weiss / Kunststoff, weiss

applique / plafonnier; plastique, blanc / plastique, blanc

L 215, H 215, A 70



### 94872 SONELLA

wall / ceiling luminaire; plastic, anthracite / plastic, white

Wand- / Deckenleuchte; Kunststoff, anthrazit / Kunststoff, weiss

applique / plafonnier; plastique, anthracite / plastique, blanc

L 215, H 215, A 70

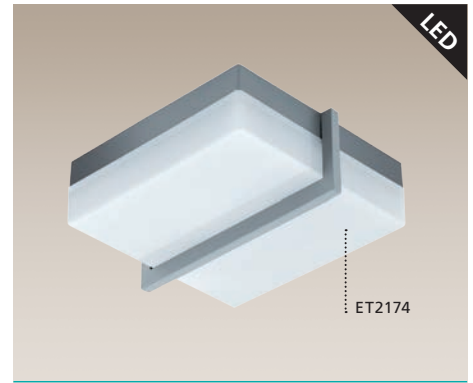

### 94876 SONELLA 1

wall / ceiling luminaire; plastic, aluminium, anthracite / plastic, white

Wand- / Deckenleuchte; Kunststoff, Alu, anthrazit / Kunststoff, weiss

applique / plafonnier; plastique, aluminium, anthracite / plastique, blanc

L 215, H 240, A 85



### 94877 INFESTO 1

wall / ceiling luminaire; stainless steel, plastic, stainless steel, silver / plastic, white

Wand- / Deckenleuchte; Edelstahl, Kunststoff, edelstahl, silber / Kunststoff, weiss

applique / plafonnier; acier inoxydable, plastique, acier inoxydable, argent / plastique, blanc

L 250, H 250, A 70

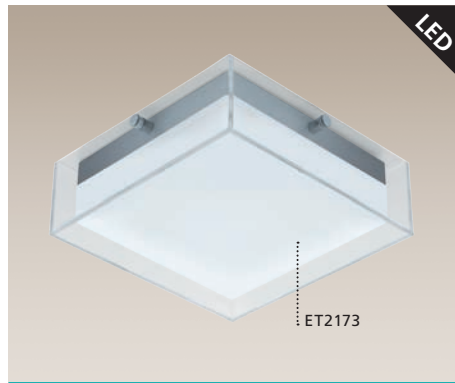

### 94874 INFESTO

wall / ceiling luminaire; plastic, steel, silver / glass, plastic, clear, anthracite

Wand- / Deckenleuchte; Kunststoff, Stahl, silber / Glas, Kunststoff, klar, anthrazit

applique / plafonnier; plastique, acier, argent / verre, plastique, clear, anthracite

L 250, H 250, A 85

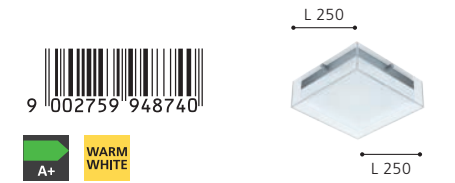



LED

### 96494 ARGOLIS

wall / ceiling luminaire; cast aluminium, white / plastic, white

Wand- / Deckenleuchte; Aluguss, weiss / Kunststoff, weiss

applique / plafonnier; aluminium moulé, blanc / plastique, blanc

L 300, B 300, H 40



9 002759 964948

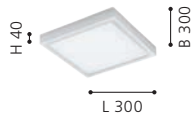

LED

### 96495 ARGOLIS

wall / ceiling luminaire; cast aluminium, anthracite / plastic, white

Wand- / Deckenleuchte; Aluguss, anthrazit / Kunststoff, weiss

applique / plafonnier; aluminium moulé, anthracite / plastique, blanc

L 300, B 300, H 40



22W



2600 lm



IP44



9 002759 964955

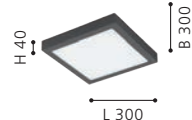



90°, 7 m  
10 - 300 sec.

### 94213 CITY LED

wall luminaire; stainless steel, stainless steel / plastic, white  
Wandleuchte; Edelstahl, edelstahl / Kunststoff, weiss  
applique; acier inoxydable, acier inoxydable / plastique, blanc

L 235, H 260, A 90

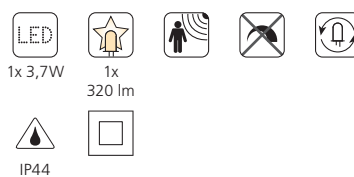

### 94212 CITY LED

wall luminaire; stainless steel, stainless steel / plastic, white  
Wandleuchte; Edelstahl, edelstahl / Kunststoff, weiss  
applique; acier inoxydable, acier inoxydable / plastique, blanc

L 235, H 260, A 90

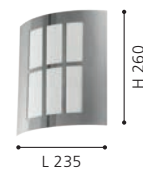
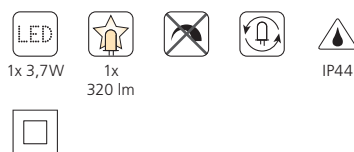



### 88144 CITY

wall luminaire; stainless steel, stainless steel / plastic, white  
Wandleuchte; Edelstahl, edelstahl / Kunststoff, weiss  
applique; acier inoxydable, acier inoxydable / plastique, blanc

L 235, H 260, A 90



### 88142 CITY

wall luminaire; stainless steel, stainless steel / plastic, white  
Wandleuchte; Edelstahl, edelstahl / Kunststoff, weiss  
applique; acier inoxydable, acier inoxydable / plastique, blanc

L 235, H 260, A 90

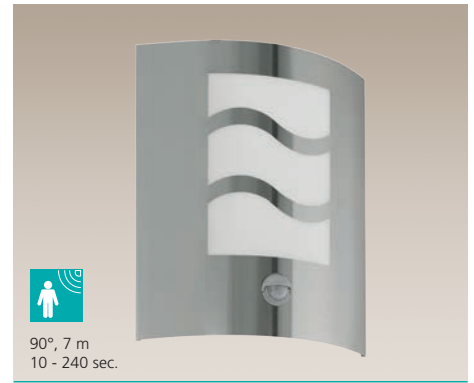
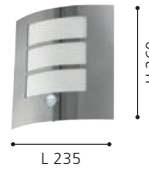

### 30194 CITY 1

wall luminaire; stainless steel, stainless steel / plastic, white  
Wandleuchte; Edelstahl, edelstahl / Kunststoff, weiss  
applique; acier inoxydable, acier inoxydable / plastique, blanc

L 230, H 300, A 90

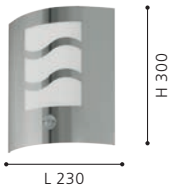

### 82309 CITY

wall luminaire; stainless steel, stainless steel / plastic, white  
Wandleuchte; Edelstahl, edelstahl / Kunststoff, weiss  
applique; acier inoxydable, acier inoxydable / plastique, blanc

L 235, H 260, A 90

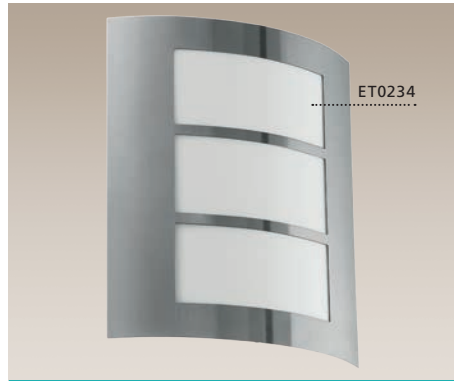
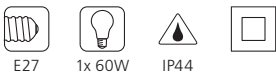

### 88139 CITY

wall luminaire; stainless steel, stainless steel / plastic, white  
Wandleuchte; Edelstahl, edelstahl / Kunststoff, weiss  
applique; acier inoxydable, acier inoxydable / plastique, blanc

L 235, H 260, A 90

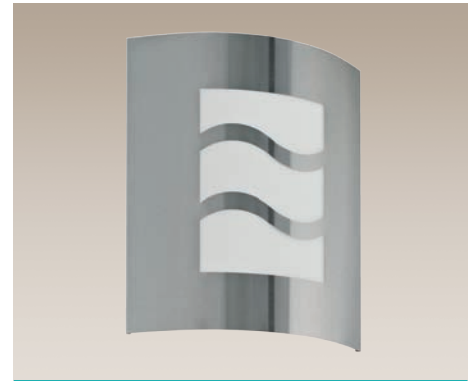
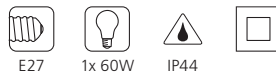

### 30193 CITY 1

wall luminaire; stainless steel, stainless steel / plastic, white  
Wandleuchte; Edelstahl, edelstahl / Kunststoff, weiss  
applique; acier inoxydable, acier inoxydable / plastique, blanc

L 230, H 300, A 90

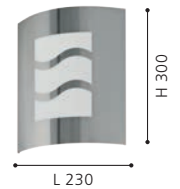
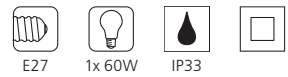



### 30191 CERNO

wall luminaire; stainless steel, stainless steel / satinated glass, white

Wandleuchte; Edelstahl, edelstahl / Glas satiniert, weiss

applique; acier inoxydable, acier inoxydable / verre satiné, blanc

L 140, H 165, A 105



### 30192 CERNO

wall luminaire; stainless steel, stainless steel / satinated glass, white

Wandleuchte; Edelstahl, edelstahl / Glas satiniert, weiss

applique; acier inoxydable, acier inoxydable / verre satiné, blanc

L 140, H 190, A 110



### 30173 DARIL

wall luminaire; stainless steel, stainless steel / plastic, clear

Wandleuchte; Edelstahl, edelstahl / Kunststoff, klar

applique; acier inoxydable, acier inoxydable / plastique, clair

L 195, H 240, A 110

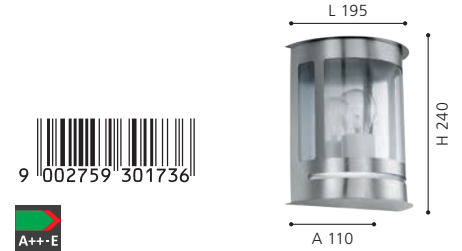

### 94797 CERNO

wall luminaire; stainless steel, stainless steel / satinated glass, white

Wandleuchte; Edelstahl, edelstahl / Glas satiniert, weiss

applique; acier inoxydable, acier inoxydable / verre satiné, blanc

L 135, H 165, A 105



### 94798 CERNO

wall luminaire; stainless steel, stainless steel / satinated glass, white

Wandleuchte; Edelstahl, edelstahl / Glas satiniert, weiss

applique; acier inoxydable, acier inoxydable / verre satiné, blanc

L 135, H 200, A 105



### 94086 RALORA

wall luminaire; stainless steel, stainless steel / plastic, white

Wandleuchte; Edelstahl, edelstahl / Kunststoff, weiss

applique; acier inoxydable, acier inoxydable / plastique, blanc

L 140, H 240, A 70





### 89366 ARCHA

wall luminaire; cast aluminium, stainless steel, satin nickel / corroded glass, white

Wandleuchte; Aluguss, edelstahl, nickel-matt / Glas geätzt, weiss

applique; aluminium moulé, acier inoxydable, nickel mat / verre rouillé, blanc

L 220, H 330, A 112



E27



1x 60W



IP54

L 220



H 330

A 112



9 002759 893668



2000 lux

### 95989 RALORA 1

wall luminaire; stainless steel, stainless steel / plastic, white

Wandleuchte; Edelstahl, edelstahl / Kunststoff, weiss

applique; acier inoxydable, acier inoxydable / plastique, blanc

L 170, H 290, A 100



12W



1000 lm



2000 lux



IP44

L 170



H 290

A 100



9 002759 959890



### 89366

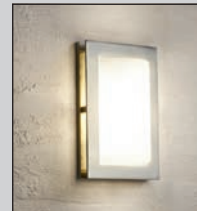

This luminaire comes with adjustable design elements made of stainless steel.

Diese Leuchte wird mit verstellbaren Zierelementen aus Edelstahl geliefert.

Ce luminaire vient avec éléments de décoration interchangeables en acier inoxydable.

### 95989



This light is equipped with one day and night sensor.

Diese Leuchte ist mit einem Tag und Nacht Sensor ausgestattet.

Cette lumière est équipée d'un jour et nuit le détecteur.

[see page / siehe Seite / voir page 139](#)



### 95073 TRABADA

wall luminaire; cast aluminium, white / plastic, white  
Wandleuchte; Aluguss, weiss / Kunststoff, weiss  
applique; aluminium moulé, blanc / plastique, blanc

L 160, H 190, A 115



### 94852 TRABADA

wall luminaire; cast aluminium, black / plastic, white  
Wandleuchte; Aluguss, schwarz / Kunststoff, weiss  
applique; aluminium moulé, noir / plastique, blanc

L 160, H 190, A 115

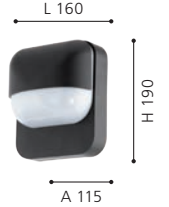

### 95074 TRABADA

wall luminaire; cast aluminium, white / plastic, white  
Wandleuchte; Aluguss, weiss / Kunststoff, weiss  
applique; aluminium moulé, blanc / plastique, blanc

L 160, H 190, A 115



### 94853 TRABADA

wall luminaire; cast aluminium, black / plastic, white  
Wandleuchte; Aluguss, schwarz / Kunststoff, weiss  
applique; aluminium moulé, noir / plastique, blanc

L 160, H 190, A 115

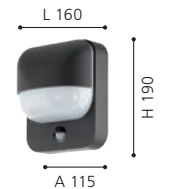



**96583 LORMES**

wall luminaire; plastic, white / plastic, white  
 Wandleuchte; Kunststoff, weiss / Kunststoff, weiss  
 applique; plastique, blanc / plastique, blanc

L 150, H 195, A 165

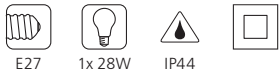

E27

1x 28W

IP44



**96584 LORMES**

wall luminaire; plastic, black / plastic, clear  
 Wandleuchte; Kunststoff, schwarz / Kunststoff, klar  
 applique; plastique, noir / plastique, clair

L 150, H 195, A 165

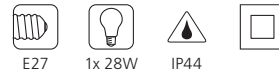

E27

1x 28W

IP44

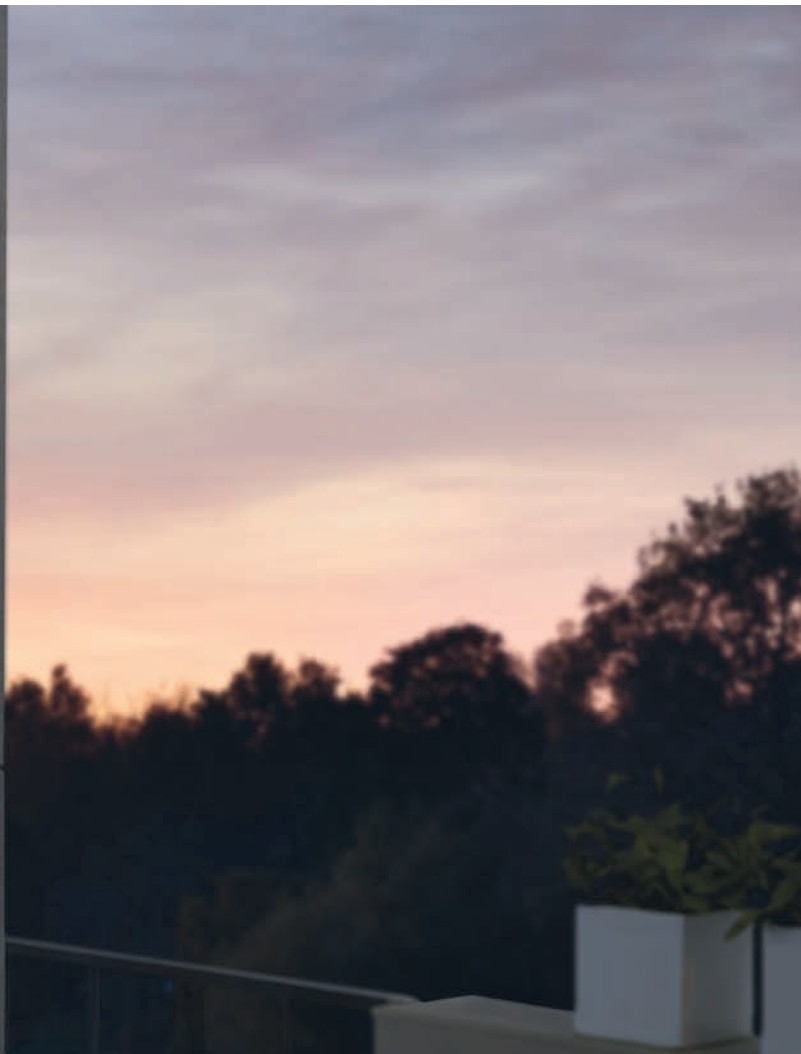



### 96491 ARGOLIS

wall / ceiling luminaire; cast aluminium, white / plastic, white

Wand- / Deckenleuchte; Aluguss, weiss / Kunststoff, weiss

applique / plafonnier; aluminium moulé, blanc / plastique, blanc

H 35, Ø 225

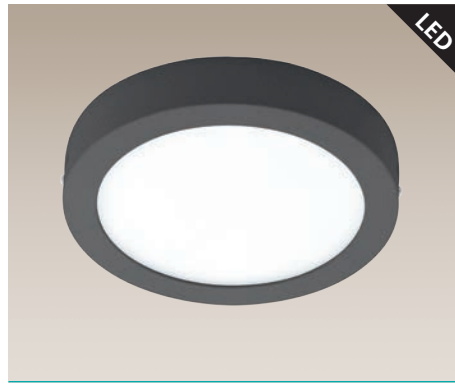

### 96492 ARGOLIS

wall / ceiling luminaire; cast aluminium, anthracite / plastic, white

Wand- / Deckenleuchte; Aluguss, anthrazit / Kunststoff, weiss

applique / plafonnier; aluminium moulé, anthracite / plastique, blanc

H 35, Ø 225



### 96365 VENTO 2

wall / ceiling luminaire; stainless steel, stainless steel / plastic, white

Wand- / Deckenleuchte; Edelstahl, edelstahl / Kunststoff, weiss

applique / plafonnier; acier inoxydable, acier inoxydable / plastique, blanc

Ø 185, A 70



### 94785 ONTANEDA

wall / ceiling luminaire; plastic, white / plastic, white

Wand- / Deckenleuchte; Kunststoff, weiss / Kunststoff, weiss

applique / plafonnier; plastique, blanc / plastique, blanc

Ø 325, A 75



### 94784 ONTANEDA

wall / ceiling luminaire; plastic, black / plastic, white

Wand- / Deckenleuchte; Kunststoff, schwarz / Kunststoff, weiss

applique / plafonnier; plastique, noir / plastique, blanc

Ø 325, A 75



### 94121 VENTO 1

wall / ceiling luminaire; stainless steel, stainless steel / glass, coated white

Wand- / Deckenleuchte; Edelstahl, edelstahl / Glas, weiss lackiert

applique / plafonnier; acier inoxydable, acier inoxydable / verre, blanc laqué

Ø 285, A 80







### 89768 ONJA

wall luminaire; cast aluminium, white / ribbed glass, clear  
Wandleuchte; Aluguss, weiss / Glas geriffelt, klar  
applique; aluminium moulé, blanc / verre strié, clair

L 220, H 155, A 150



### 89769 ONJA

wall luminaire; cast aluminium, silver / ribbed glass, clear  
Wandleuchte; Aluguss, silber / Glas geriffelt, klar  
applique; aluminium moulé, argent / verre strié, clair

L 220, H 155, A 150

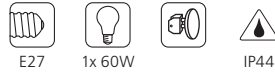

### 89767 ONJA

wall luminaire; cast aluminium, black / ribbed glass, clear  
Wandleuchte; Aluguss, schwarz / Glas geriffelt, klar  
applique; aluminium moulé, noir / verre strié, clair

L 220, H 155, A 150

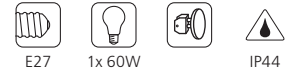

### ONJA

With direkt and/or indirect light this luminaire create a spectacular effect.

Diese Leuchten schaffen durch direktes und/oder indirektes Licht einen tollen Effekt.

Ce luminaire créé un effets lumineux special pour une illumination direct et/ou indirect.



### 96353 ISOBA

wall luminaire; cast aluminium, white / plastic, white  
Wandleuchte; Aluguss, weiss / Kunststoff, weiss  
applique; aluminium moulé, blanc / plastique, blanc

L 160, H 220, A 105

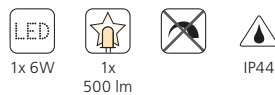

WARM WHITE



### 96354 ISOBA

wall luminaire; cast aluminium, silver / plastic, white  
Wandleuchte; Aluguss, silber / Kunststoff, weiss  
applique; aluminium moulé, argent / plastique, blanc

L 160, H 220, A 105

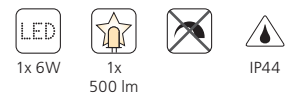

WARM WHITE

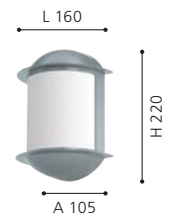





### 96338 SIONES 1

wall / ceiling luminaire; cast aluminium, white / structured glass, white

Wand- / Deckenleuchte; Aluguss, weiss / Glas mit Struktur, weiss

applique / plafonnier; aluminium moulé, blanc / verre structuré, blanc

L 145, H 215, A 100

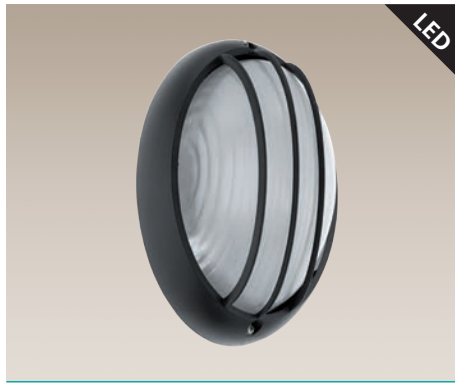
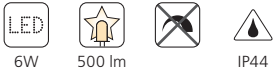

### 96339 SIONES 1

wall / ceiling luminaire; cast aluminium, black / structured glass, white

Wand- / Deckenleuchte; Aluguss, schwarz / Glas mit Struktur, weiss

applique / plafonnier; aluminium moulé, noir / verre structuré, blanc

L 145, H 215, A 100



### 96341 SIONES 1

wall / ceiling luminaire; cast aluminium, white / structured glass, white

Wand- / Deckenleuchte; Aluguss, weiss / Glas mit Struktur, weiss

applique / plafonnier; aluminium moulé, blanc / verre structuré, blanc

Ø 260, A 100



### 96342 SIONES 1

wall / ceiling luminaire; cast aluminium, black / structured glass, white

Wand- / Deckenleuchte; Aluguss, schwarz / Glas mit Struktur, weiss

applique / plafonnier; aluminium moulé, noir / verre structuré, blanc

Ø 260, A 100





### 88807 ANOLA

wall / ceiling luminaire; plastic, white / glass, clear  
Wand- / Deckenleuchte; Kunststoff, weiss / Glas, klar  
applique / plafonnier; plastique, blanc / verre, clair

Ø 185, A 100



E27



1x 40W



10x



IP44



9 002759 888077



Ø 185



A 100

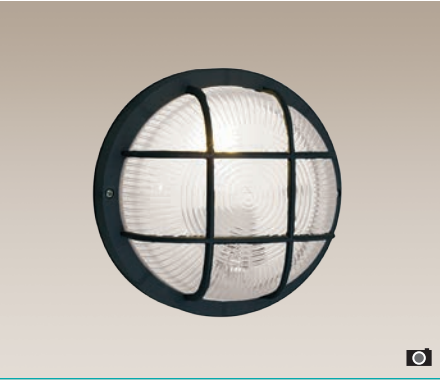

### 88803 ANOLA

wall / ceiling luminaire; plastic, black / glass, clear  
Wand- / Deckenleuchte; Kunststoff, schwarz / Glas, klar  
applique / plafonnier; plastique, noir / verre, clair

Ø 185, A 100



E27



1x 40W



10x



IP44



9 002759 888039



Ø 185



A 100



### 88802 ANOLA

wall / ceiling luminaire; plastic, black / glass, clear  
Wand- / Deckenleuchte; Kunststoff, schwarz / Glas, klar  
applique / plafonnier; plastique, noir / verre, clair

L 203, B 113, A 94



E27



1x 40W



10x



IP44



9 002759 888022



B 113



L 203

A 94





### 88489 MILTON

wall luminaire; steel, hot-dip galvanised / glass, clear

Wandleuchte; Stahl, feuerverzinkt / Glas, klar

applique; acier, galvanisé à chaud / verre, clair

H 310, A 310



### 88119 SEVILLA

wall / ceiling luminaire; steel, hot-dip galvanised / satinated glass, white

Wand- / Deckenleuchte; Stahl, feuerverzinkt / Glas satiniert, weiss

applique / plafonnier; acier, galvanisé à chaud / verre satiné, blanc

Ø 285, A 83



### 96206 ENTRIMO

wall luminaire; galvanized steel, hot-dip galvanised / plastic, white

Wandleuchte; Stahl verzinkt, feuerverzinkt / Kunststoff, weiss

applique; acier galvanisé, galvanisé à chaud / plastique, blanc

L 200, H 185, A 235



### 88487 CITY

wall luminaire; stainless steel, hot-dip galvanised / plastic, white

Wandleuchte; Edelstahl, feuerverzinkt / Kunststoff, weiss

applique; acier inoxydable, galvanisé à chaud / plastique, blanc

L 235, H 260, A 90

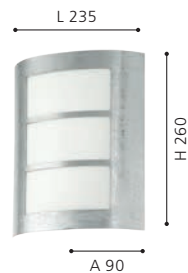
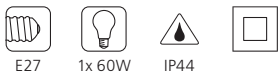

### 90867 LEPUS

wall luminaire; steel, hot-dip galvanised / plastic, white

Wandleuchte; Stahl, feuerverzinkt / Kunststoff, weiss

applique; acier, galvanisé à chaud / plastique, blanc

L 235, H 120, A 125





15 years guarantee against corrosion on the hot dipped galvanized surface.

15 Jahre Garantie gegen Korrosion der feuerverzinkten Oberfläche.

Garantie de 15 ans contre la corrosion de surface galvanisé à chaud.



Klassik  
Classic  
Classique

Übersicht  
 Overview  
 Apersu

 <b>COMUNERO</b> p. 70	 <b>ALAMONTE</b> p. 72	 <b>ALAMONTE 1</b> p. 74	 <b>BARROSELA</b> p. 76	 <b>HILBURN 1</b> p. 76	 <b>HILBURN</b> p. 78	 <b>PULFERO</b> p. 80	 <b>PULFERO 1</b> p. 82
 <b>MONASTERIO</b> p. 84	 <b>MONASTERIO</b> p. 84	 <b>MELGOA</b> p. 86	 <b>BARROSELA</b> p. 86	 <b>COLINDRES 1</b> p. 86	 <b>COLINDRES</b> p. 87	 <b>BARROSELA</b> p. 87	 <b>MELGOA</b> p. 87
 <b>ENTRIMO</b> p. 88	 <b>TOLLERA</b> p. 88	 <b>FACUNDA</b> p. 88	 <b>ALBACETE</b> p. 88	 <b>MAMURRA</b> p. 90	 <b>APIMARE</b> p. 90	 <b>APIMARE</b> p. 90	 <b>VALDEO</b> p. 90
 <b>SESIMBA</b> p. 92	 <b>BREGANZO</b> p. 92	 <b>SEVILIA</b> p. 92	 <b>ALAMONTE 2</b> p. 92	 <b>ISOBA</b> p. 92	 <b>ALORIA</b> p. 95	 <b>SIDNEY</b> p. 96	 <b>ALORIA</b> p. 98
 <b>LISIO</b> p. 100	 <b>MOUNA</b> p. 102	 <b>MINORCA</b> p. 104	 <b>MILTON</b> p. 105	 <b>SAN TELMO</b> p. 105	 <b>NABILA 1</b> p. 105	 <b>NAVEDO</b> p. 106	 <b>LATERNA 7</b> p. 107
 <b>NAVEDO</b> p. 108	 <b>NAVEDO</b> p. 109	 <b>NAVEDO</b> p. 110	 <b>LATERNA 5</b> p. 112	 <b>LATERNA 5</b> p. 113	 <b>LATERNA 4</b> p. 114	 <b>LATERNA 4</b> p. 115	 <b>OUTDOOR CLASSIC</b> p. 117



### 96297 COMUNERO

floor luminaire; cast aluminium, black, silver / plastic, clear, white

Stehleuchte; Aluguss, schwarz, silber / Kunststoff, klar, weiss

lampadaire; aluminium moulé, noir, argent / plastique, clair, blanc

H 1000, Ø 175, Base: Ø 110

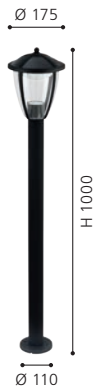

### 96295 COMUNERO

wall luminaire; cast aluminium, black, silver / plastic, clear, white  
Wandleuchte; Aluguss, schwarz, silber / Kunststoff, klar, weiss  
applique; aluminium moulé, noir, argent / plastique, clair, blanc

L 175, H 275, A 225



### 96294 COMUNERO

wall luminaire; cast aluminium, black, silver / plastic, clear, white  
Wandleuchte; Aluguss, schwarz, silber / Kunststoff, klar, weiss  
applique; aluminium moulé, noir, argent / plastique, clair, blanc

L 175, H 275, A 225



### 96296 COMUNERO

pedestal luminaire; cast aluminium, black, silver / plastic, clear, white

Sockelleuchte; Aluguss, schwarz, silber / Kunststoff, klar, weiss

borne; aluminium moulé, noir, argent / plastique, clair, blanc

H 300, Ø 175, Base: Ø 110

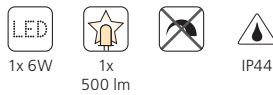





### 94786 ALAMONTE

pendant luminaire; stainless steel, stainless steel / glass, clear  
 Hängeleuchte; Edelstahl, edelstahl / Glas, klar  
 luminaire suspension; acier inoxydable, acier inoxydable / verre, clair

### 94827 ALAMONTE

wall luminaire; stainless steel, stainless steel / glass, clear  
 Wandleuchte; Edelstahl, edelstahl / Glas, klar  
 applique; acier inoxydable, acier inoxydable / verre, clair

L 150, B 150, H 1285



L 170, H 260, A 100

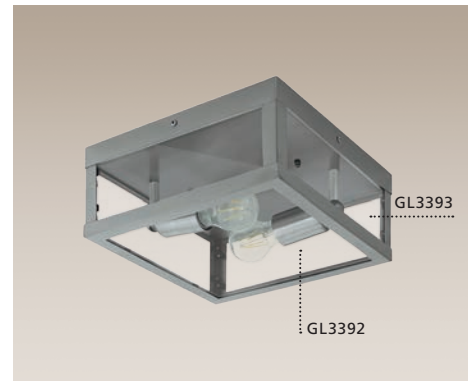
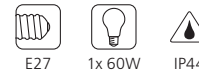

### 94787 ALAMONTE

table luminaire; stainless steel, stainless steel / glass, clear  
 Tischleuchte; Edelstahl, edelstahl / Glas, klar  
 luminaire de table; acier inoxydable, acier inoxydable / verre, clair

### 94828 ALAMONTE

wall / ceiling luminaire; stainless steel, stainless steel / glass, clear  
 Wand- / Deckenleuchte; Edelstahl, edelstahl / Glas, klar  
 applique / plafonnier; acier inoxydable, acier inoxydable / verre, clair

L 150, B 150, H 1015, Base: Ø 110

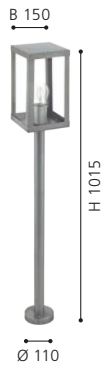

L 150, B 150, H 275

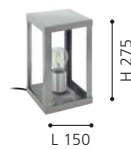
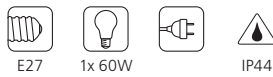

L 290, H 290, A 130

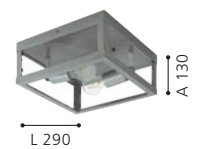
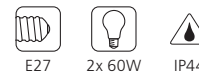





### 94833 ALAMONTE 1

floor luminaire; galvanized steel, black / glass, clear  
 Stehleuchte; Stahl verzinkt, schwarz / Glas, klar  
 lampadaire; acier galvanisé, noir / verre, clair

L 150, B 150, H 1015, Base: Ø 110



### 94788 ALAMONTE 1

pendant luminaire; galvanized steel, black / glass, clear  
 Hängeleuchte; Stahl verzinkt, schwarz / Glas, klar  
 luminaire suspension; acier galvanisé, noir / verre, clair

L 150, B 150, H 1285



### 94831 ALAMONTE 1

wall luminaire; galvanized steel, black / glass, clear  
 Wandleuchte; Stahl verzinkt, schwarz / Glas, klar  
 applique; acier galvanisé, noir / verre, clair

L 170, H 260, A 100



### 94789 ALAMONTE 1

table luminaire; galvanized steel, black / glass, clear  
 Tischleuchte; Stahl verzinkt, schwarz / Glas, klar  
 luminaire de table; acier galvanisé, noir / verre, clair

L 150, B 150, H 275

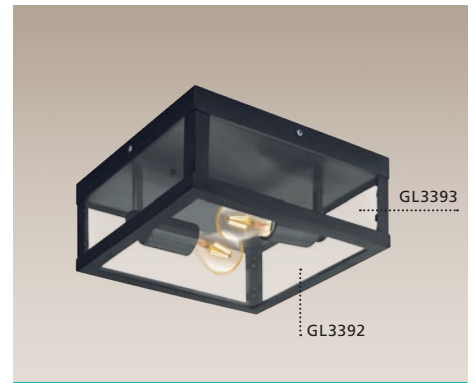
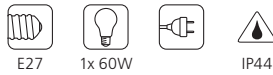

### 94832 ALAMONTE 1

wall / ceiling luminaire; galvanized steel, black / glass, clear  
 Wand- / Deckenleuchte; Stahl verzinkt, schwarz / Glas, klar  
 applique / plafonnier; acier galvanisé, noir / verre, clair

L 290, H 290, A 130







### 94868 HILBURN 1

floor luminaire; galvanized steel, antique silver / plastic, transparent

Stehleuchte; Stahl verzinkt, silber-antik / Kunststoff, transparent

lampadaire; acier galvanisé, argent antique / plastique, transparent

L 200, B 135, H 1030



9 002759 948689



### 94865 HILBURN 1

wall luminaire; galvanized steel, antique silver / plastic, transparent

Wandleuchte; Stahl verzinkt, silber-antik / Kunststoff, transparent

applique; acier galvanisé, argent antique / plastique, transparent

L 200, H 375, A 170

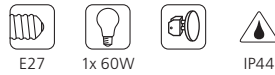

9 002759 948658



### 94866 HILBURN 1

wall luminaire; galvanized steel, antique silver / plastic, transparent

Wandleuchte; Stahl verzinkt, silber-antik / Kunststoff, transparent

applique; acier galvanisé, argent antique / plastique, transparent

L 200, H 280, A 200

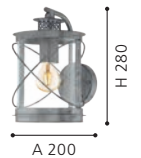
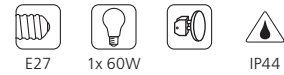

9 002759 948665



### 94867 HILBURN 1

pedestal luminaire; galvanized steel, antique silver / plastic, transparent

Sockelleuchte; Stahl verzinkt, silber-antik / Kunststoff, transparent

borne; acier galvanisé, argent antique / plastique, transparent

L 200, B 135, H 410



9 002759 948672



### 94859 BARROSELA

wall luminaire; galvanized steel, antique silver / plastic, white

Wandleuchte; Stahl verzinkt, silber-antik / Kunststoff, weiss

applique; acier galvanisé, argent antique / plastique, blanc

L 220, H 240, A 230

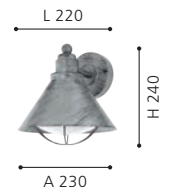
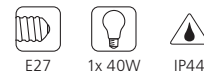

9 002759 948597







### 94844 HILBURN

floor luminaire; galvanized steel, black / plastic, transparent  
 Stehleuchte; Stahl verzinkt, schwarz / Kunststoff, transparent  
 lampadaire; acier galvanisé, noir / plastique, transparent

L 200, B 135, H 1030



9 002759 948443



### 94842 HILBURN

wall luminaire; galvanized steel, black / plastic, transparent  
 Wandleuchte; Stahl verzinkt, schwarz / Kunststoff, transparent  
 applique; acier galvanisé, noir / plastique, transparent

L 200, H 375, A 170

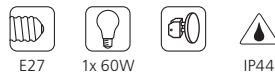

9 002759 948429



### 94843 HILBURN

wall luminaire; galvanized steel, black / plastic, transparent  
 Wandleuchte; Stahl verzinkt, schwarz / Kunststoff, transparent  
 applique; acier galvanisé, noir / plastique, transparent

L 200, H 280, A 200

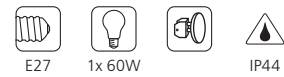

9 002759 948436



### 94864 HILBURN

pedestal luminaire; galvanized steel, black / plastic, transparent  
 Sockelleuchte; Stahl verzinkt, schwarz / Kunststoff, transparent  
 borne; acier galvanisé, noir / plastique, transparent

L 200, B 135, H 410



9 002759 948641







### 94836 PULFERO

floor luminaire; galvanized steel, black / plastic, transparent  
 Stehleuchte; Stahl verzinkt, schwarz / Kunststoff, transparent  
 lampadaire; acier galvanisé, noir / plastique, transparent

H 1020, Ø 220, Base: Ø 110



### 94834 PULFERO

wall luminaire; galvanized steel, black / plastic, transparent  
 Wandleuchte; Stahl verzinkt, schwarz / Kunststoff, transparent  
 applique; acier galvanisé, noir / plastique, transparent

L 220, H 280, A 280



### 94841 PULFERO

wall luminaire; galvanized steel, black / plastic, transparent  
 Wandleuchte; Stahl verzinkt, schwarz / Kunststoff, transparent  
 applique; acier galvanisé, noir / plastique, transparent

L 220, H 280, A 280



### 94835 PULFERO

pedestal luminaire; galvanized steel, black / plastic, transparent  
 Sockelleuchte; Stahl verzinkt, schwarz / Kunststoff, transparent  
 borne; acier galvanisé, noir / plastique, transparent

H 415, Ø 220, Base: Ø 110







### 94857 PULFERO 1

floor luminaire; galvanized steel, brown / plastic, transparent  
 Stehleuchte; Stahl verzinkt, braun / Kunststoff, transparent  
 lampadaire; acier galvanisé, marron / plastique, transparent

H 1020, Ø 220, Base: Ø 110

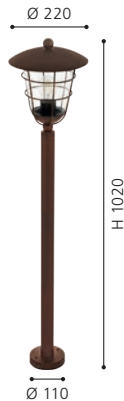

### 94854 PULFERO 1

wall luminaire; galvanized steel, brown / plastic, transparent  
 Wandleuchte; Stahl verzinkt, braun / Kunststoff, transparent  
 applique; acier galvanisé, marron / plastique, transparent

L 220, H 280, A 280



### 94855 PULFERO 1

wall luminaire; galvanized steel, brown / plastic, transparent  
 Wandleuchte; Stahl verzinkt, braun / Kunststoff, transparent  
 applique; acier galvanisé, marron / plastique, transparent

L 220, H 280, A 280



### 94856 PULFERO 1

pedestal luminaire; galvanized steel, brown / plastic, transparent  
 Sockelleuchte; Stahl verzinkt, braun / Kunststoff, transparent  
 borne; acier galvanisé, marron / plastique, transparent

H 415, Ø 220, Base: Ø 110







### 95976 MONASTERIO

wall luminaire; galvanized steel, black / satinated glass, white  
 Wandleuchte; Stahl verzinkt, schwarz / Glas satiniert, weiss  
 applique; acier galvanisé, noir / verre satiné, blanc

L 220, H 265, A 235



### 95978 MONASTERIO

floor luminaire; galvanized steel, antique silver / satinated glass, white  
 Stehleuchte; Stahl verzinkt, silber-antik / Glas satiniert, weiss  
 lampadaire; acier galvanisé, argent antique / verre satiné, blanc

L 320, B 220, H 1065, Base: Ø 110

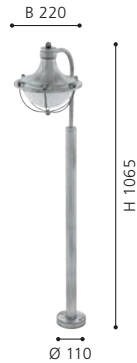

### 95977 MONASTERIO

floor luminaire; galvanized steel, black / satinated glass, white  
 Stehleuchte; Stahl verzinkt, schwarz / Glas satiniert, weiss  
 lampadaire; acier galvanisé, noir / verre satiné, blanc

L 320, B 220, H 1065, Base: Ø 110

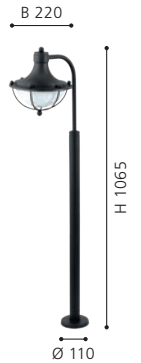
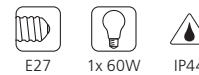

### 95978 MONASTERIO

wall luminaire; galvanized steel, antique silver / satinated glass, white  
 Wandleuchte; Stahl verzinkt, silber-antik / Glas satiniert, weiss  
 applique; acier galvanisé, argent antique / verre satiné, blanc

L 220, H 265, A 235

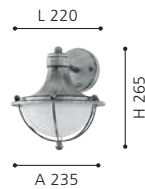





**94861 COLINDRES 1**

pendant luminaire; galvanized steel, black / plastic, white

Hängeleuchte; Stahl verzinkt, schwarz / Kunststoff, weiss

luminaire suspension; acier galvanisé, noir / plastique, blanc

H 1270, Ø 215



**94862 COLINDRES 1**

wall luminaire; galvanized steel, black / plastic, white

Wandleuchte; Stahl verzinkt, schwarz / Kunststoff, weiss

applique; acier galvanisé, noir / plastique, blanc

L 215, H 290, A 275



**94805 BARROSELA**

wall luminaire; galvanized steel, black / plastic, white

Wandleuchte; Stahl verzinkt, schwarz / Kunststoff, weiss

applique; acier galvanisé, noir / plastique, blanc

L 220, H 240, A 230



**94792 MELGOA**

wall luminaire; galvanized steel, black / glass, clear

Wandleuchte; Stahl verzinkt, schwarz / Glas, klar

applique; acier galvanisé, noir / verre, clair

L 300, H 250, A 380



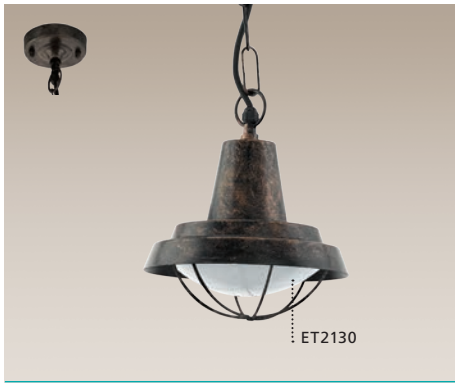

### 94837 COLINDRES

pendant luminaire; galvanized steel, copper-antique / plastic, white

Hängeleuchte; Stahl verzinkt, kupferfarben-antik / Kunststoff, weiss

luminaire suspension; acier galvanisé, cuivré / plastique, blanc

H 1270, Ø 215



E27



1x 60W



IP44



9 002759 948375



### 94858 BARROSELA

wall luminaire; galvanized steel, copper-antique / plastic, white

Wandleuchte; Stahl verzinkt, kupferfarben-antik / Kunststoff, weiss

applique; acier galvanisé, cuivré / plastique, blanc

L 220, H 240, A 230



E27



1x 40W



IP44



9 002759 948580



### 94838 COLINDRES

wall luminaire; galvanized steel, copper-antique / plastic, white

Wandleuchte; Stahl verzinkt, kupferfarben-antik / Kunststoff, weiss

applique; acier galvanisé, cuivré / plastique, blanc

L 215, H 290, A 275



E27



1x 60W



IP44



9 002759 948382



### 94863 MELGOA

wall luminaire; galvanized steel, copper-antique / glass, clear

Wandleuchte; Stahl verzinkt, kupferfarben-antik / Glas, klar

applique; acier galvanisé, cuivré / verre, clair

L 300, H 250, A 380



E27



1x 60W



IP44



9 002759 948634





### 96207 ENTRIMO

wall luminaire; galvanized steel, black / plastic, white

Wandleuchte; Stahl verzinkt, schwarz / Kunststoff, weiss

applique; acier galvanisé, noir / plastique, blanc

L 200, H 185, A 235



### 96234 TOLLERA

wall luminaire; galvanized steel, antique silver / plastic, white

Wandleuchte; Stahl verzinkt, silber-antik / Kunststoff, weiss

applique; acier galvanisé, argent antique / plastique, blanc

L 225, H 180, A 255



### 96262 ALBACETE

wall luminaire; galvanized steel, brown, copper / glass with blowholes, clear

Wandleuchte; Stahl verzinkt, braun, kupfer / Glas mit Lufteinschlüssen, klar

applique; acier galvanisé, brown, copper / verre bullé, clair

L 265, H 255, A 280



### 96236 FACUNDA

wall luminaire; galvanized steel, black / glass, clear

Wandleuchte; Stahl verzinkt, schwarz / Glas, klar

applique; acier galvanisé, noir / verre, clair

L 165, H 355, A 175



### 96235 TOLLERA

wall luminaire; galvanized steel, copper-antique / plastic, white

Wandleuchte; Stahl verzinkt, kupferfarben-antik / Kunststoff, weiss

applique; acier galvanisé, cuivré / plastique, blanc

L 225, H 180, A 255

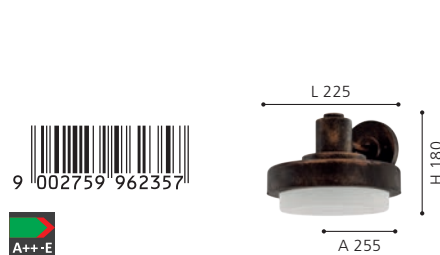

### 96263 ALBACETE

wall luminaire; galvanized steel, antique silver / glass with blowholes, clear

Wandleuchte; Stahl verzinkt, silber-antik / Glas mit Lufteinschlüssen, klar

applique; acier galvanisé, argent antique / verre bullé, clair

L 265, H 255, A 280







### 96239 VALDEO

wall luminaire; galvanized steel, black / glass, clear

Wandleuchte; Stahl verzinkt, schwarz / Glas, klar

applique; acier galvanisé, noir / verre, clair

L 165, H 275, A 200



### 96223 MAMURRA

wall luminaire; galvanized steel, brown / glass with blowholes, clear

Wandleuchte; Stahl verzinkt, braun / Glas mit Lufteinschlüssen, klar

applique; acier galvanisé, marron / verre bullé, clair

L 150, H 345, A 180



### 96232 APIMARE

wall luminaire; galvanized steel, black / glass with blowholes, clear

Wandleuchte; Stahl verzinkt, schwarz / Glas mit Lufteinschlüssen, klar

applique; acier galvanisé, noir / verre bullé, clair

L 140, H 310, A 215



### 96241 VALDEO

wall luminaire; galvanized steel, copper-antique / glass, clear

Wandleuchte; Stahl verzinkt, kupferfarben-antik / Glas, klar

applique; acier galvanisé, cuivré / verre, clair

L 165, H 275, A 200



### 96222 MAMURRA

wall luminaire; galvanized steel, black / glass with blowholes, clear

Wandleuchte; Stahl verzinkt, schwarz / Glas mit Lufteinschlüssen, klar

applique; acier galvanisé, noir / verre bullé, clair

L 150, H 345, A 180



### 96233 APIMARE

wall luminaire; galvanized steel, dark brown / glass with blowholes, clear

Wandleuchte; Stahl verzinkt, dunkelbraun / Glas mit Lufteinschlüssen, klar

applique; acier galvanisé, marron foncé / verre bullé, clair

L 140, H 310, A 215

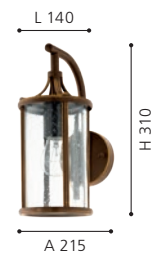





### 96267 SESIMBA

wall luminaire; galvanized steel, antique silver / plastic, transparent

Wandleuchte; Stahl verzinkt, silber-antik / Kunststoff, transparent

applique; acier galvanisé, argent antique / plastique, transparent

L 110, H 110, A 140

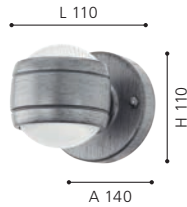

### 96268 SESIMBA

wall luminaire; galvanized steel, dark brown / plastic, transparent

Wandleuchte; Stahl verzinkt, dunkelbraun / Kunststoff, transparent

applique; acier galvanisé, marron foncé / plastique, transparent

L 110, H 110, A 140

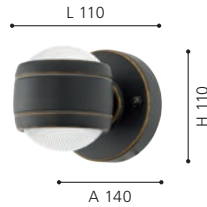

### 96269 BREGANZO

wall luminaire; galvanized steel, dark brown / plastic, white

Wandleuchte; Stahl verzinkt, dunkelbraun / Kunststoff, weiss

applique; acier galvanisé, marron foncé / plastique, blanc

L 180, H 250, A 115



### 96272 ALAMONTE 2

wall luminaire; galvanized steel, copper-antique / glass, clear

Wandleuchte; Stahl verzinkt, kupferfarben-antik / Glas, klar

applique; acier galvanisé, cuivré / verre, clair

L 170, H 260, A 100



### 96273 ISOBA

wall luminaire; cast aluminium, copper-antique / plastic, white

Wandleuchte; Aluguss, kupferfarben-antik / Kunststoff, weiss

applique; aluminium moulé, cuivré / plastique, blanc

L 160, H 220, A 105

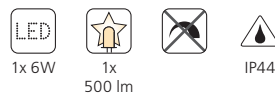

### 96271 SEVILIA

wall luminaire; galvanized steel, copper-antique / satinated glass, white

Wandleuchte; Stahl verzinkt, kupferfarben-antik / Glas satiniert, weiss

applique; acier galvanisé, cuivré / verre satiné, blanc

Ø 285, A 83







### 93409 ALORIA

floor luminaire; cast aluminium, black / plastic, clear  
 Stehleuchte; Aluguss, schwarz / Kunststoff, klar  
 lampadaire; aluminium moulé, noir / plastique, clair

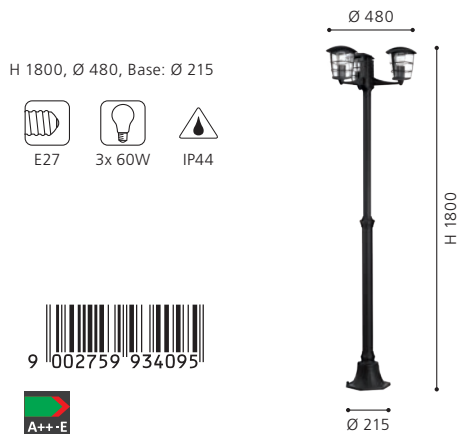

### 93408 ALORIA

floor luminaire; cast aluminium, black / plastic, clear  
 Stehleuchte; Aluguss, schwarz / Kunststoff, klar  
 lampadaire; aluminium moulé, noir / plastique, clair

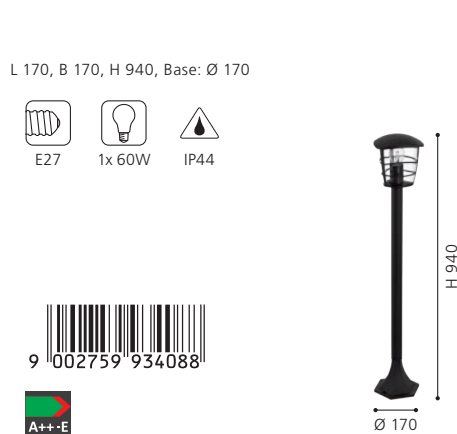

### 93406 ALORIA

pendant luminaire; cast aluminium, black / plastic, clear  
 Hängeleuchte; Aluguss, schwarz / Kunststoff, klar  
 luminaire suspension; aluminium moulé, noir / plastique, clair

L 170, B 170, H 685



### 93099 ALORIA

pedestal luminaire; cast aluminium, black / plastic, clear  
 Sockelleuchte; Aluguss, schwarz / Kunststoff, klar  
 borne; aluminium moulé, noir / plastique, clair

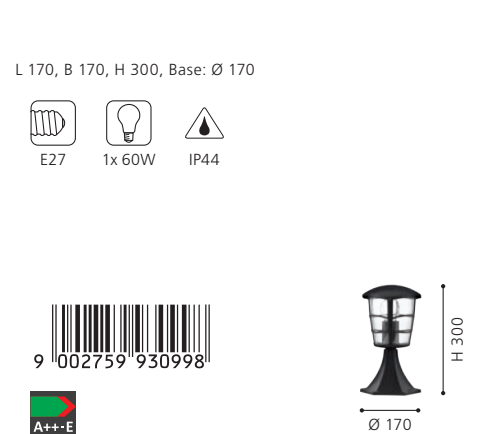



### 93097 ALORIA

wall luminaire; cast aluminium, black / plastic, clear  
Wandleuchte; Aluguss, schwarz / Kunststoff, klar  
applique; aluminium moulé, noir / plastique, clair

L 170, H 225, A 190



E27



1x 60W



IP44



9 002759 930974



### 93098 ALORIA

wall luminaire; cast aluminium, black / plastic, clear  
Wandleuchte; Aluguss, schwarz / Kunststoff, klar  
applique; aluminium moulé, noir / plastique, clair

L 170, H 225, A 190



E27



1x 60W



IP44



9 002759 930981



### 93407 ALORIA

wall luminaire; cast aluminium, black / plastic, clear  
Wandleuchte; Aluguss, schwarz / Kunststoff, klar  
applique; aluminium moulé, noir / plastique, clair

L 180, H 200, A 120



E27



1x 60W



IP44



9 002759 934071



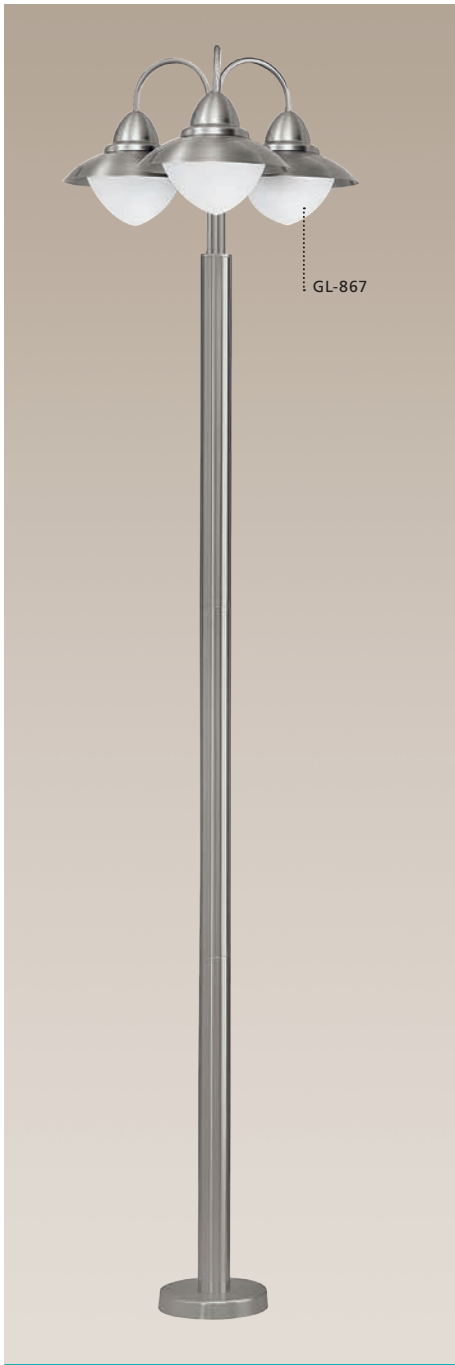

### 83971 SIDNEY

floor luminaire; stainless steel, stainless steel / satinated glass, white

Stehleuchte; Edelstahl, edelstahl / Glas satiniert, weiss

lampadaire; acier inoxydable, acier inoxydable / verre satiné, blanc

H 2200, Ø 600, Base: Ø 200

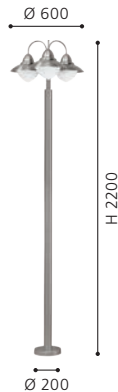

9 002759 839710



### 83969 SIDNEY

floor luminaire; stainless steel, stainless steel / satinated glass, white

Stehleuchte; Edelstahl, edelstahl / Glas satiniert, weiss

lampadaire; acier inoxydable, acier inoxydable / verre satiné, blanc

B 350, H 1200, Base: Ø 120

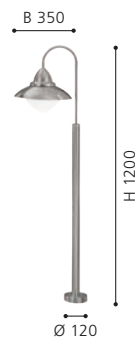

9 002759 839697



### 83966 SIDNEY

wall luminaire; stainless steel, stainless steel / satinated glass, white

Wandleuchte; Edelstahl, edelstahl / Glas satiniert, weiss

applique; acier inoxydable, acier inoxydable / verre satiné, blanc

H 375, Ø 270, A 325



9 002759 839666



### 87105 SIDNEY

wall luminaire; stainless steel, stainless steel / satinated glass, white

Wandleuchte; Edelstahl, edelstahl / Glas satiniert, weiss

applique; acier inoxydable, acier inoxydable / verre satiné, blanc

H 375, Ø 275, A 325

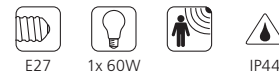

9 002759 871055







### 93405 ALORIA

floor luminaire; cast aluminium, white / plastic, clear  
 Stehleuchte; Aluguss, weiss / Kunststoff, klar  
 lampadaire; aluminium moulé, blanc / plastique, clair

H 1800, Ø 480, Base: Ø 215

E27
 3x 60W
 IP44

9 002759 934057



### 93404 ALORIA

floor luminaire; cast aluminium, white / plastic, clear  
 Stehleuchte; Aluguss, weiss / Kunststoff, klar  
 lampadaire; aluminium moulé, blanc / plastique, clair

L 170, B 170, H 940, Base: Ø 170

E27
 1x 60W
 IP44

9 002759 934040



### 93402 ALORIA

pendant luminaire; cast aluminium, white / plastic, clear  
 Hängeleuchte; Aluguss, weiss / Kunststoff, klar  
 luminaire suspension; aluminium moulé, blanc / plastique, clair

L 170, B 170, H 685

E27
 1x 60W
 IP44

9 002759 934026

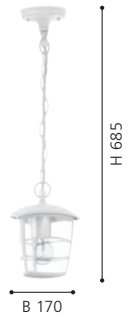

### 93096 ALORIA

pedestal luminaire; cast aluminium, white / plastic, clear  
 Sockelleuchte; Aluguss, weiss / Kunststoff, klar  
 borne; aluminium moulé, blanc / plastique, clair

L 170, B 170, H 300, Base: Ø 170

E27
 1x 60W
 IP44

9 002759 930967





### 93094 ALORIA

wall luminaire; cast aluminium, white / plastic, clear  
 Wandleuchte; Aluguss, weiss / Kunststoff, klar  
 applique; aluminium moulé, blanc / plastique, clair

L 170, H 225, A 190



E27



1x 60W



IP44



9 002759 930943



### 93095 ALORIA

wall luminaire; cast aluminium, white / plastic, clear  
 Wandleuchte; Aluguss, weiss / Kunststoff, klar  
 applique; aluminium moulé, blanc / plastique, clair

L 170, H 225, A 190



E27



1x 60W



IP44



9 002759 930950



### 93403 ALORIA

wall luminaire; cast aluminium, white / plastic, clear  
 Wandleuchte; Aluguss, weiss / Kunststoff, klar  
 applique; aluminium moulé, blanc / plastique, clair

L 180, H 200, A 120



E27



1x 60W



IP44



9 002759 934033





### 30186 LISIO

pendant luminaire; stainless steel, stainless steel / glass, clear  
 Hängeleuchte; Edelstahl, edelstahl / Glas, klar  
 luminaire suspension; acier inoxydable, acier inoxydable / verre, clair

H 880, Ø 175



9 002759 301866



### 30188 LISIO

floor luminaire; stainless steel, stainless steel / glass, clear  
 Stehleuchte; Edelstahl, edelstahl / Glas, klar  
 lampadaire; acier inoxydable, acier inoxydable / verre, clair

H 1000, Ø 175, Base: Ø 130



9 002759 301880

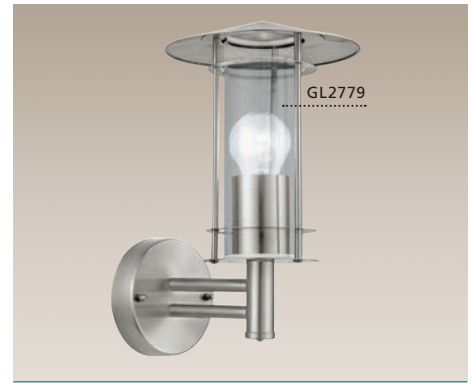
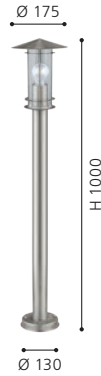

### 30184 LISIO

wall luminaire; stainless steel, stainless steel / glass, clear  
 Wandleuchte; Edelstahl, edelstahl / Glas, klar  
 applique; acier inoxydable, acier inoxydable / verre, clair

L 175, H 300, A 225



9 002759 301842

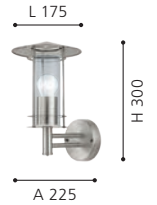

### 30187 LISIO

floor luminaire; stainless steel, stainless steel / glass, clear  
 Stehleuchte; Edelstahl, edelstahl / Glas, klar  
 lampadaire; acier inoxydable, acier inoxydable / verre, clair

H 500, Ø 175, Base: Ø 130



9 002759 301873

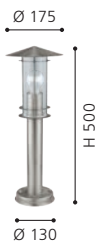

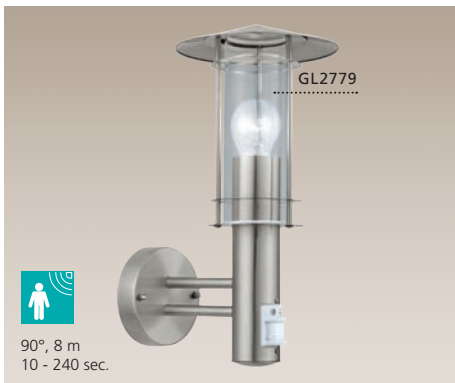

### 30185 LISIO

wall luminaire; stainless steel, stainless steel / glass, clear  
 Wandleuchte; Edelstahl, edelstahl / Glas, klar  
 applique; acier inoxydable, acier inoxydable / verre, clair

L 175, H 360, A 225



E27



1x 60W



IP44



9 002759 301859

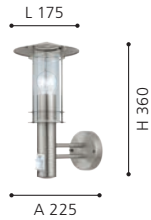

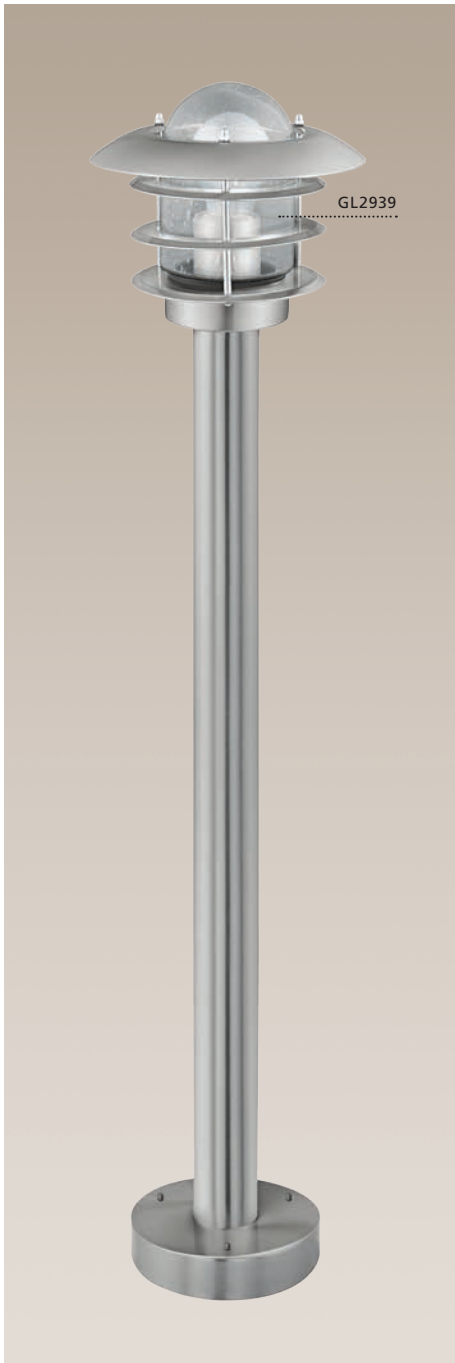

### 30182 MOUNA

floor luminaire; stainless steel, stainless steel / glass, clear  
 Stehleuchte; Edelstahl, edelstahl / Glas, klar  
 lampadaire; acier inoxydable, acier inoxydable / verre, clair

H 400, Ø 205, Base: Ø 150

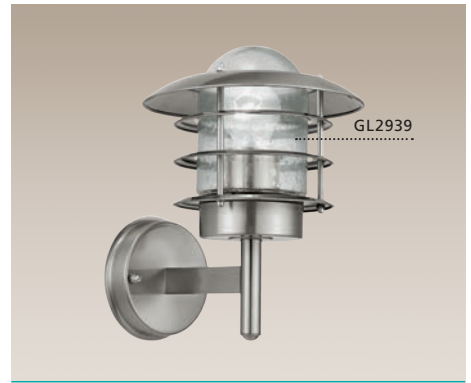

### 30181 MOUNA

wall luminaire; stainless steel, stainless steel / glass, clear  
 Wandleuchte; Edelstahl, edelstahl / Glas, klar  
 applique; acier inoxydable, acier inoxydable / verre, clair

H 260, Ø 205, A 240

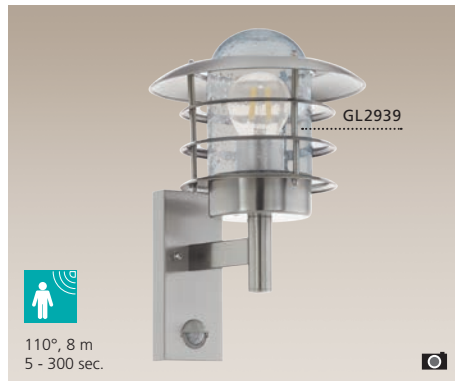
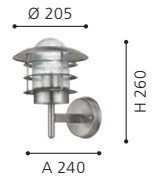
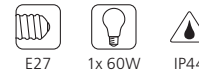

### 96402 MOUNA

wall luminaire; stainless steel, stainless steel / glass, clear  
 Wandleuchte; Edelstahl, edelstahl / Glas, klar  
 applique; acier inoxydable, acier inoxydable / verre, clair

H 265, Ø 220, A 240

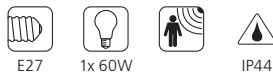

### 83588 MILTON

wall luminaire; stainless steel, stainless steel / glass, clear  
 Wandleuchte; Edelstahl, edelstahl / Glas, klar  
 applique; acier inoxydable, acier inoxydable / verre, clair

B 240, H 310, A 300

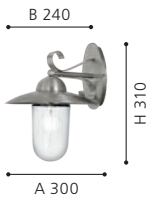
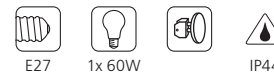

### 30183 MOUNA

floor luminaire; stainless steel, stainless steel / glass, clear  
 Stehleuchte; Edelstahl, edelstahl / Glas, klar  
 lampadaire; acier inoxydable, acier inoxydable / verre, clair

H 950, Ø 205, Base: Ø 150

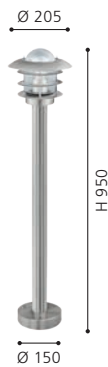





### 89535 MINORCA

pedestal luminaire; galvanized steel, coppery / opal glass, shiny white

Sockelleuchte; Stahl verzinkt, kupferfarben / Glas opal, weiss glänzend

borne; acier galvanisé, cuivré / verre opale, blanc brillant

H 385, Ø 137, Base: Ø 100



### 89533 MINORCA

wall luminaire; galvanized steel, coppery / opal glass, shiny white

Wandleuchte; Stahl verzinkt, kupferfarben / Glas opal, weiss glänzend

applique; acier galvanisé, cuivré / verre opale, blanc brillant

B 137, H 365, A 185

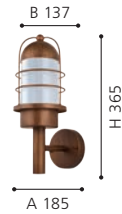
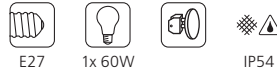

### 89536 MINORCA

floor luminaire; galvanized steel, coppery / opal glass, shiny white

Stehleuchte; Stahl verzinkt, kupferfarben / Glas opal, weiss glänzend

lampadaire; acier galvanisé, cuivré / verre opale, blanc brillant

H 785, Ø 137, Base: Ø 100





### 83589 MILTON

wall luminaire; galvanized steel, antique brown / glass, clear

Wandleuchte; Stahl verzinkt, antik-braun / Glas, klar

applique; acier galvanisé, marron antique / verre, clair

B 240, H 310, A 300



E27



1x 60W



IP44



9 002759 835897



### 94807 NABILA 1

wall luminaire; galvanized steel, antique brown / glass, clear

Wandleuchte; Stahl verzinkt, antik-braun / Glas, klar

applique; acier galvanisé, marron antique / verre, clair

L 110, H 385, A 155



E27



1x 60W



IP44



9 002759 948078



### 90184 SAN TELMO

wall luminaire; galvanized steel, cast aluminium, antique brown / glass with blowholes, clear

Wandleuchte; Stahl verzinkt, Aluguss, antik-braun / Glas mit Lufteinschlüssen, klar

applique; marron antique / verre bullé, clair

L 180, H 350, A 240



E27



1x 60W



IP23



9 002759 901844





### 93456 NAVEDO

wall luminaire; cast aluminium, black, patina silver / glass, clear  
Wandleuchte; Aluguss, schwarz, silber-patina / Glas, klar  
applique; aluminium moulé, noir, argent patiné / verre, clair

L 200, H 475, A 285



### 93457 NAVEDO

wall luminaire; cast aluminium, black, patina silver / glass, clear  
Wandleuchte; Aluguss, schwarz, silber-patina / Glas, klar  
applique; aluminium moulé, noir, argent patiné / verre, clair

L 200, H 475, A 285



### 93458 NAVEDO

wall luminaire; cast aluminium, black, patina silver / glass, clear  
Wandleuchte; Aluguss, schwarz, silber-patina / Glas, klar  
applique; aluminium moulé, noir, argent patiné / verre, clair

L 200, H 425, A 285

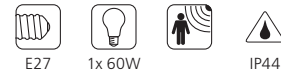

### 93459 NAVEDO

wall luminaire; cast aluminium, black, patina silver / glass, clear  
Wandleuchte; Aluguss, schwarz, silber-patina / Glas, klar  
applique; aluminium moulé, noir, argent patiné / verre, clair

L 290, H 430, A 130



### 93462 NAVEDO

pedestal luminaire; cast aluminium, black, patina silver / glass, clear  
Sockelleuchte; Aluguss, schwarz, silber-patina / Glas, klar  
borne; aluminium moulé, noir, argent patiné / verre, clair

H 470, Ø 230, Base: Ø 170



### 93455 NAVEDO

pendant luminaire; cast aluminium, black, patina silver / glass, clear  
Hängeleuchte; Aluguss, schwarz, silber-patina / Glas, klar  
luminaire suspension; aluminium moulé, noir, argent patiné / verre, clair

H 1045, Ø 230





### 5389 LATERNA 7

wall / ceiling luminaire; cast aluminium, black / satinated glass, white  
Wand- / Deckenleuchte; Aluguss, schwarz / Glas satiniert, weiss  
applique / plafonnier; aluminium moulé, noir / verre satiné, blanc

Ø 230, A 140



E27



1x 60W



IP44



Ø 230



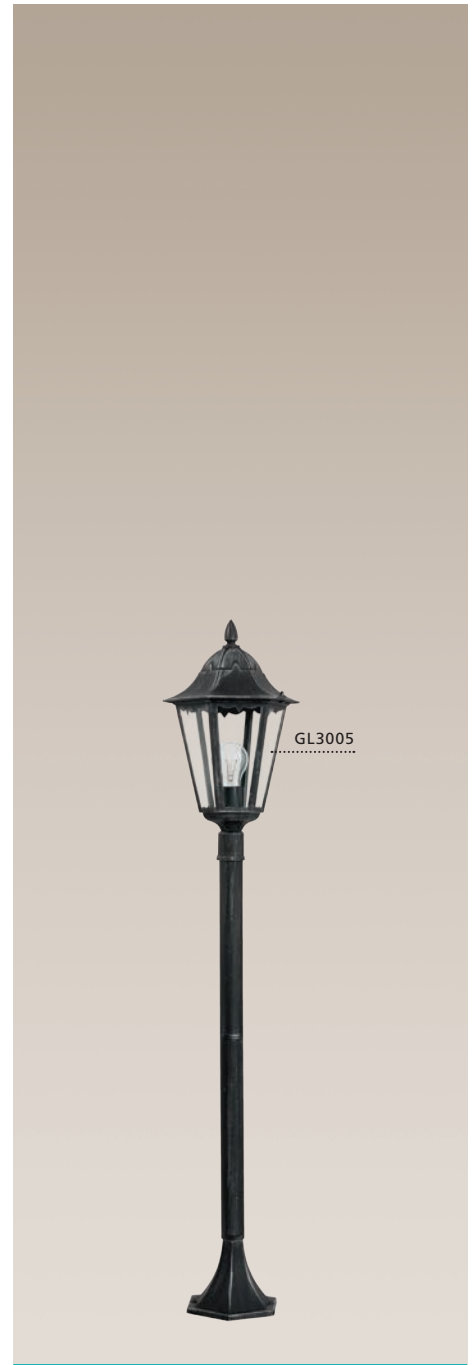

### 93465 NAVEDO

floor luminaire; cast aluminium, black, patina silver / glass, clear  
 Stehleuchte; Aluguss, schwarz, silber-patina / Glas, klar  
 lampadaire; aluminium moulé, noir, argent patiné / verre, clair

### 93464 NAVEDO

floor luminaire; cast aluminium, black, patina silver / glass, clear  
 Stehleuchte; Aluguss, schwarz, silber-patina / Glas, klar  
 lampadaire; aluminium moulé, noir, argent patiné / verre, clair

### 93463 NAVEDO

floor luminaire; cast aluminium, black, patina silver / glass, clear  
 Stehleuchte; Aluguss, schwarz, silber-patina / Glas, klar  
 lampadaire; aluminium moulé, noir, argent patiné / verre, clair

H 2200, Ø 560, Base: Ø 230

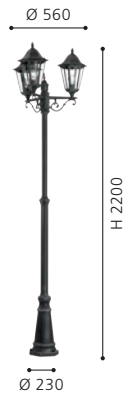

9 002759 934651



H 2000, Ø 230, Base: Ø 245



9 002759 934644



H 1200, Ø 230, Base: Ø 170

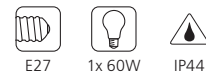

9 002759 934637





### 93454 NAVEDO

floor luminaire; cast aluminium, white / glass, clear  
 Stehleuchte; Aluguss, weiss / Glas, klar  
 lampadaire; aluminium moulé, blanc / verre, clair

H 2200, Ø 560, Base: Ø 230



9 002759 934545



### 93453 NAVEDO

floor luminaire; cast aluminium, white / glass, clear  
 Stehleuchte; Aluguss, weiss / Glas, klar  
 lampadaire; aluminium moulé, blanc / verre, clair

H 2000, Ø 230, Base: Ø 245

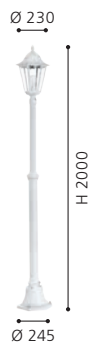

9 002759 934538

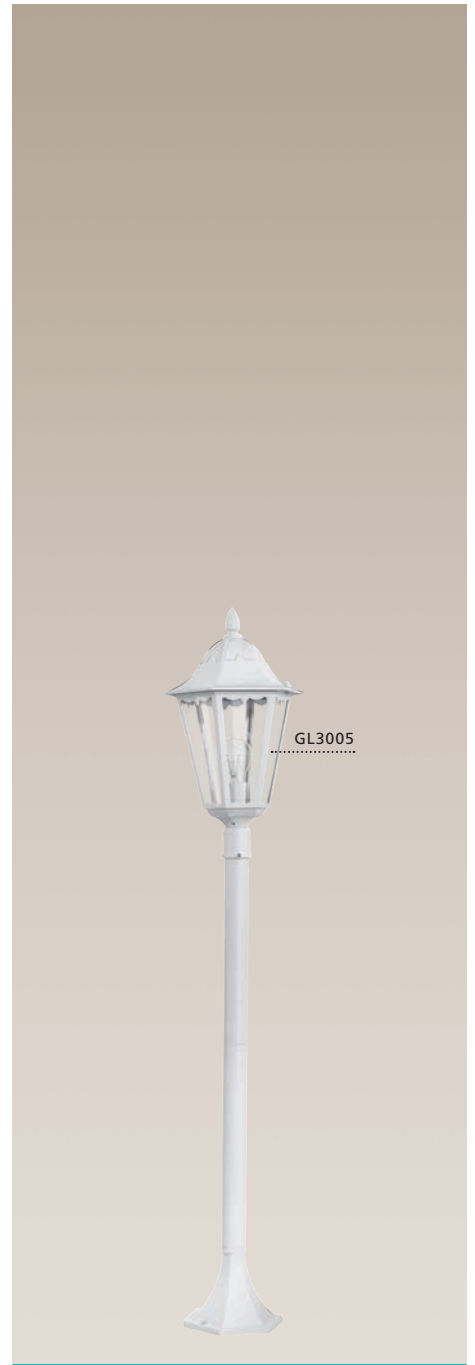

### 93452 NAVEDO

floor luminaire; cast aluminium, white / glass, clear  
 Stehleuchte; Aluguss, weiss / Glas, klar  
 lampadaire; aluminium moulé, blanc / verre, clair

H 1200, Ø 230, Base: Ø 170

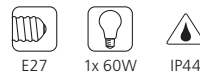

9 002759 934521





### 93445 NAVEDO

wall luminaire; cast aluminium, white / glass, clear  
Wandleuchte; Aluguss, weiss / Glas, klar  
applique; aluminium moulé, blanc / verre, clair

L 200, H 475, A 285



### 93446 NAVEDO

wall luminaire; cast aluminium, white / glass, clear  
Wandleuchte; Aluguss, weiss / Glas, klar  
applique; aluminium moulé, blanc / verre, clair

L 200, H 475, A 285



### 93447 NAVEDO

wall luminaire; cast aluminium, white / glass, clear  
Wandleuchte; Aluguss, weiss / Glas, klar  
applique; aluminium moulé, blanc / verre, clair

L 200, H 425, A 285

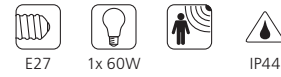

### 93448 NAVEDO

wall luminaire; cast aluminium, white / glass, clear  
Wandleuchte; Aluguss, weiss / Glas, klar  
applique; aluminium moulé, blanc / verre, clair

L 290, H 430, A 130



### 93451 NAVEDO

pedestal luminaire; cast aluminium, white / glass, clear  
Sockelleuchte; Aluguss, weiss / Glas, klar  
borne; aluminium moulé, blanc / verre, clair

H 470, Ø 230, Base: Ø 170



### 93444 NAVEDO

pendant luminaire; cast aluminium, white / glass, clear  
Hängeleuchte; Aluguss, weiss / Glas, klar  
luminaire suspension; aluminium moulé, blanc / verre, clair

H 1045, Ø 230







### 22996 LATERNA 5

floor luminaire; cast aluminium, white / glass, clear  
 Stehleuchte; Aluguss, weiss / Glas, klar  
 lampadaire; aluminium moulé, blanc / verre, clair

H 1920, Ø 550, Base: Ø 260



9 002759 229962



### 22995 LATERNA 5

floor luminaire; cast aluminium, white / glass, clear  
 Stehleuchte; Aluguss, weiss / Glas, klar  
 lampadaire; aluminium moulé, blanc / verre, clair

H 1000, Ø 205, Base: Ø 170



9 002759 229955



### 22465 LATERNA 5

pendant luminaire; cast aluminium, white / glass, clear  
 Hängeleuchte; Aluguss, weiss / Glas, klar  
 luminaire suspension; aluminium moulé, blanc / verre, clair

H 900, Ø 205

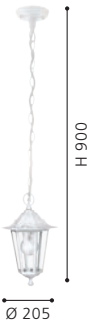

9 002759 224653



### 22466 LATERNA 5

pedestal luminaire; cast aluminium, white / glass, clear  
 Sockelleuchte; Aluguss, weiss / Glas, klar  
 borne; aluminium moulé, blanc / verre, clair

H 405, Ø 205, Base: Ø 170

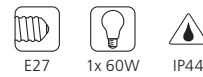

9 002759 224660





### 22463 LATERNA 5

wall luminaire; cast aluminium, white / glass, clear  
Wandleuchte; Aluguss, weiss / Glas, klar  
applique; aluminium moulé, blanc / verre, clair

L 165, H 350, A 215



E27



1x 60W



IP44



9 002759 224639



### 22462 LATERNA 5

wall luminaire; cast aluminium, white / glass, clear  
Wandleuchte; Aluguss, weiss / Glas, klar  
applique; aluminium moulé, blanc / verre, clair

L 165, H 350, A 215



E27



1x 60W



IP44



9 002759 224622



### 22464 LATERNA 5

wall luminaire; cast aluminium, white / glass, clear  
Wandleuchte; Aluguss, weiss / Glas, klar  
applique; aluminium moulé, blanc / verre, clair

L 165, H 425, A 235



E27



1x 60W



IP44



9 002759 224646





### 22145 LATERNA 4

floor luminaire; cast aluminium, black / glass, clear  
 Stehleuchte; Aluguss, schwarz / Glas, klar  
 lampadaire; aluminium moulé, noir / verre, clair

H 1920, Ø 550, Base: Ø 260



### 22144 LATERNA 4

floor luminaire; cast aluminium, black / glass, clear  
 Stehleuchte; Aluguss, schwarz / Glas, klar  
 lampadaire; aluminium moulé, noir / verre, clair

H 1000, Ø 205, Base: Ø 170



### 22471 LATERNA 4

pendant luminaire; cast aluminium, black / glass, clear  
 Hängeleuchte; Aluguss, schwarz / Glas, klar  
 luminaire suspension; aluminium moulé, noir / verre, clair

H 900, Ø 205



### 22472 LATERNA 4

pedestal luminaire; cast aluminium, black / glass, clear  
 Sockelleuchte; Aluguss, schwarz / Glas, klar  
 borne; aluminium moulé, noir / verre, clair

L 205, B 165, H 405, Base: Ø 170

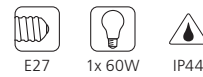



### 22467 LATERNA 4

wall luminaire; cast aluminium, black / glass, clear  
 Wandleuchte; Aluguss, schwarz / Glas, klar  
 applique; aluminium moulé, noir / verre, clair

L 165, H 350, A 215



E27



1x 60W



IP44



9 002759 224677



### 22468 LATERNA 4

wall luminaire; cast aluminium, black / glass, clear  
 Wandleuchte; Aluguss, schwarz / Glas, klar  
 applique; aluminium moulé, noir / verre, clair

L 165, H 350, A 215



E27



1x 60W



IP44



9 002759 224684



### 22469 LATERNA 4

wall luminaire; cast aluminium, black / glass, clear  
 Wandleuchte; Aluguss, schwarz / Glas, klar  
 applique; aluminium moulé, noir / verre, clair

L 165, H 425, A 235



E27



1x 60W



IP44



9 002759 224691



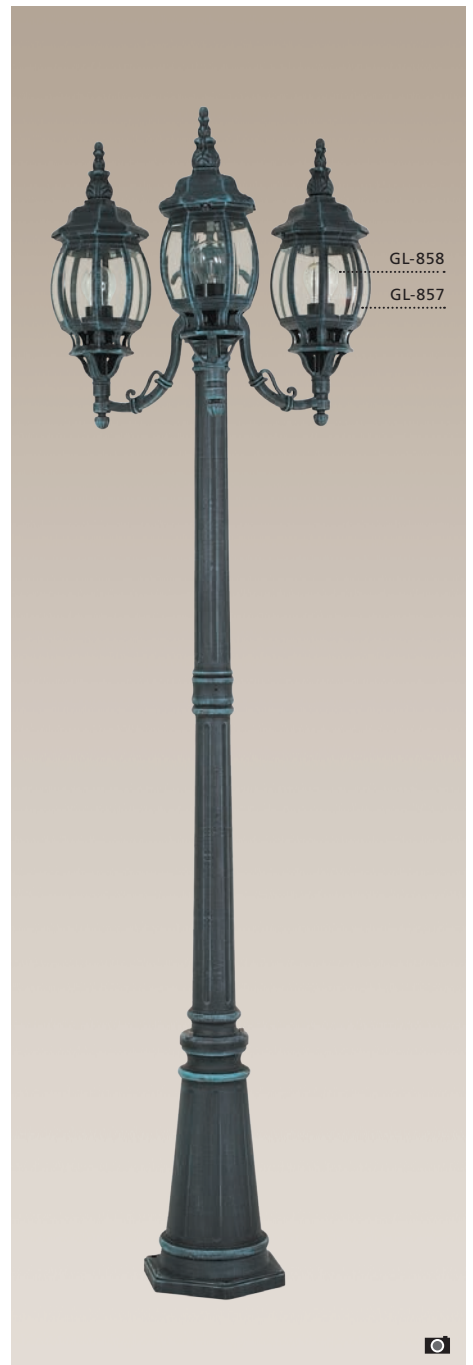

**4171 OUTDOOR CLASSIC**

floor luminaire; cast aluminium, black-green / glass, clear  
 Stehleuchte; Aluguss, schwarz-grün / Glas, klar  
 lampadaire; aluminium moulé, noir-vert / verre, clair

H 2130, Ø 530, Base: Ø 250



E27



3x 60W



IP23

Ø 530



H 2130

Ø 250



9 002759 417109





### 4172 OUTDOOR CLASSIC

floor luminaire; cast aluminium, black-green / glass, clear  
 Stehleuchte; Aluguss, schwarz-grün / Glas, klar  
 lampadaire; aluminium moulé, noir-vert / verre, clair

H 1200, Ø 190, Base: Ø 150



### 4174 OUTDOOR CLASSIC

wall luminaire; cast aluminium, black-green / glass, clear  
 Wandleuchte; Aluguss, schwarz-grün / Glas, klar  
 applique; aluminium moulé, noir-vert / verre, clair

B 190, H 530, A 260



### 4175 OUTDOOR CLASSIC

wall luminaire; cast aluminium, black-green / glass, clear  
 Wandleuchte; Aluguss, schwarz-grün / Glas, klar  
 applique; aluminium moulé, noir-vert / verre, clair

B 190, H 480, A 260

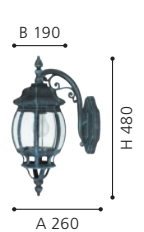

### 4173 OUTDOOR CLASSIC

pedestal luminaire; cast aluminium, black-green / glass, clear  
 Sockelleuchte; Aluguss, schwarz-grün / Glas, klar  
 borne; aluminium moulé, noir-vert / verre, clair

H 600, Ø 190, Base: Ø 150





Spots, Einbauleuchten & Zubehör

Spots / Recessed & Accessories

Spots, luminaires encastrés & accessoires

Übersicht  
 Overview  
 Apersu

 NEMA 1 p. 120	 NEMA 1 p. 120	 RIGA 1 p. 120	 NEMA p. 120	 FAEDO 2 p. 121	 FAEDO 1 p. 122	 ZIMBA p. 124	 ZIMBA p. 124	
 ZIMBA-LED p. 124	 ZIMBA-LED p. 124	 RIGA 3 p. 126	 LAMEDO p. 126	 LAMEDO p. 126	 MARGO p. 126	 PINEDA-IP p. 127	 DETECT ME 1 p. 128	
 DETECT ME 1 p. 128	 DETECT ME 2 p. 128	 DETECT ME 3 p. 128	 DETECT ME 4 p. 129	 PARK 4 p. 130	 CONNECTOR BOX p. 130	 CONNECTOR BOX p. 130	 PARK 4 p. 130	
 PARK T p. 130	 CUBA p. 131	 p. 131						



### 94109 RIGA 1

ground spike; stainless steel, stainless steel  
 Erdspieß; Edelstahl, edelstahl  
 acier inoxydable, acier inoxydable

B 140, H 630



### 93384 NEMA 1

ground spike; plastic, black / plastic, transparent  
 Erdspieß; Kunststoff, schwarz / Kunststoff, transparent  
 plastique, noir / plastique, transparent

L 115, B 60, H 185



### 93385 NEMA 1

ground spike; plastic, black / plastic, transparent  
 Erdspieß; Kunststoff, schwarz / Kunststoff, transparent  
 plastique, noir / plastique, transparent

L 115, B 115, H 180

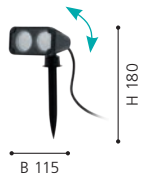

### 94111 NEMA

ground spike; stainless steel, stainless steel  
 Erdspieß; Edelstahl, edelstahl  
 acier inoxydable, acier inoxydable

L 110, B 85, H 240, ET 165

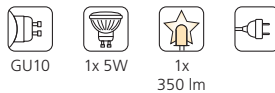



- GL2640      ● GL2642
- GL2641      ● GL2643

### 94111

NEMA comes with 3 different coloured bulb shades.

NEMA wird mit 3 verschiedenen farbigen Leuchtmittelabdeckungen ausgeliefert.

NEMA vient avec 3 couvercles d'ampoule en couleurs différentes.



### 96284 FAEDO 2

ground spike; aluminium, black / glass, clear  
 Erdspieß; Alu, schwarz / Glas, klar  
 aluminium, noir / verre, clair

L 130, B 50, H 405

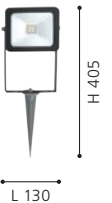

### 96285 FAEDO 2

ground spike; aluminium, silver / glass, clear  
 Erdspieß; Alu, silber / Glas, klar  
 aluminium, argent / verre, clair

L 130, B 50, H 405

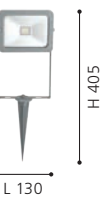



### 95403 FAEDO 1

wall luminaire; aluminium, silver / glass, clear  
Wandleuchte; Alu, silber / Glas, klar  
applique; aluminium, argent / verre, clair

L 130, H 105, A 50



### 95404 FAEDO 1

wall luminaire; aluminium, silver / glass, clear  
Wandleuchte; Alu, silber / Glas, klar  
applique; aluminium, argent / verre, clair

L 160, H 140, A 50

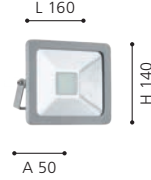
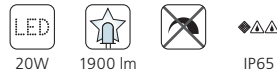

### 95405 FAEDO 1

wall luminaire; aluminium, silver / glass, clear  
Wandleuchte; Alu, silber / Glas, klar  
applique; aluminium, argent / verre, clair

L 205, H 155, A 50

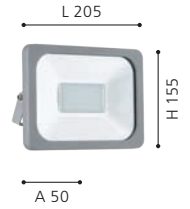

### 95407 FAEDO 1

wall luminaire; aluminium, silver / glass, clear  
Wandleuchte; Alu, silber / Glas, klar  
applique; aluminium, argent / verre, clair

L 130, H 190, A 50



### 95408 FAEDO 1

wall luminaire; aluminium, silver / glass, clear  
Wandleuchte; Alu, silber / Glas, klar  
applique; aluminium, argent / verre, clair

L 160, H 220, A 50



### 95409 FAEDO 1

wall luminaire; aluminium, silver / glass, clear  
Wandleuchte; Alu, silber / Glas, klar  
applique; aluminium, argent / verre, clair

L 205, H 235, A 50





### 95406 FAEDO 1

wall luminaire; aluminium, silver / glass, clear  
 Wandleuchte; Alu, silber / Glas, klar  
 applique; aluminium, argent / verre, clair

L 245, H 175, A 50



50W



4450 lm



IP65



9 002759 954062



### 95411 FAEDO 1

wall luminaire; aluminium, silver / glass, clear  
 Wandleuchte; Alu, silber / Glas, klar  
 applique; aluminium, argent / verre, clair

L 245, H 250, A 50



50W



4450 lm



IP44



9 002759 954116

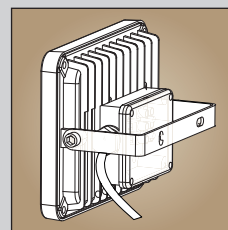

### FAEDO 1

Luminaire with extraflat housing.  
 Leuchte mit extraflachen Gehäuse.  
 Luminaire avec boîtier extra plat.

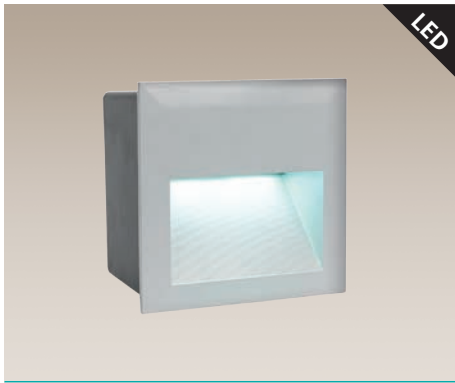

### 95235 ZIMBA-LED

recessed luminaire; cast aluminium, silver  
 Einbauleuchte; Aluguss, silber  
 luminaire encastrable; aluminium moulé, argent

L 140, B 140, H 5, ET 95

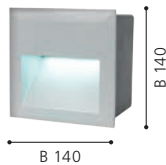

### 95234 ZIMBA-LED

recessed luminaire; cast aluminium, silver  
 Einbauleuchte; Aluguss, silber  
 luminaire encastrable; aluminium moulé, argent

L 235, B 185, H 5, ET 95



### 95233 ZIMBA-LED

recessed luminaire; cast aluminium, silver  
 Einbauleuchte; Aluguss, silber  
 luminaire encastrable; aluminium moulé, argent

H 5, Ø 125, ET 95



### 88008 ZIMBA

recessed luminaire; cast aluminium, silver  
 Einbauleuchte; Aluguss, silber  
 luminaire encastrable; aluminium moulé, argent

L 243, B 101, H 5, ET 100

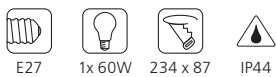

### 88575 ZIMBA

recessed luminaire; cast aluminium, silver / satinated glass, white  
 Einbauleuchte; Aluguss, silber / Glas satiniert, weiss  
 luminaire encastrable; aluminium moulé, argent / verre satiné, blanc

L 227, B 127, H 13, ET 75

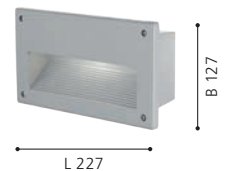
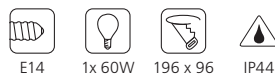



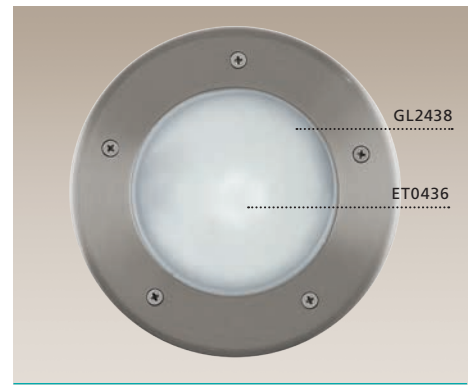

### 93481 LAMEDO

ground recessed luminaire; stainless steel, stainless steel / satinated glass, white  
 Bodeneinbauleuchte; Edelstahl, edelstahl / Glas satiniert, weiss  
 luminaire encastrable au; acier inoxydable, acier inoxydable / verre satiné, blanc  
 L 100, B 100, ET 65

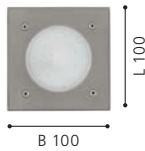
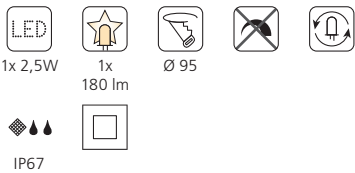

### 93482 LAMEDO

ground recessed luminaire; stainless steel, stainless steel / satinated glass, white  
 Bodeneinbauleuchte; Edelstahl, edelstahl / Glas satiniert, weiss  
 luminaire encastrable au; acier inoxydable, acier inoxydable / verre satiné, blanc  
 Ø 100, ET 65



### 86189 RIGA 3

ground recessed luminaire; stainless steel, stainless steel / plastic, white  
 Bodeneinbauleuchte; Edelstahl, edelstahl / Kunststoff, weiss  
 luminaire encastrable au; acier inoxydable, acier inoxydable / plastique, blanc  
 H 285, Ø 170

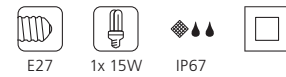

### GROUND RECESSED LUMINAIRE



### LAMEDO & RIGA 3

No more annoying cables in your garden: bury them simply and safely with the CONNECTOR BOX.

Mit der CONNECTOR BOX können Sie störende Kabel einfach und sicher unter der Erde verschwinden lassen.

Tous les câbles incommodes disparaissent simplement et sûrement dans votre jardin avec CONNECTOR BOX.



IP20

### RECESSED LUMINAIRE



### PINEDA IP & MARGO

IP65 / IP44

These luminaires are protected with IP65 / IP44 on the frontside and IP20 on the backside.

Diese Leuchten sind mit IP65 / IP44 frontseitig und IP20 rückseitig geschützt.

Disposent d'un degré de protection élevé IP65 / IP44 en face avant et IP20 en face arrière pour l'utilisation.

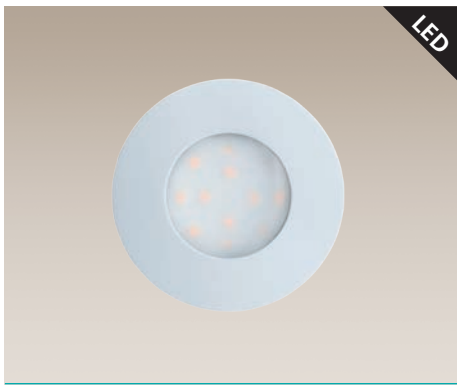

### 96414 PINEDA-IP

recessed luminaire; plastic, white  
 Einbauleuchte; Kunststoff, weiss  
 luminaire encastrable; plastique, blanc

Ø 78, ET 35

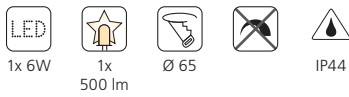

Ø 78



### 96415 PINEDA-IP

recessed luminaire; plastic, satin nickel  
 Einbauleuchte; Kunststoff, nickel-matt  
 luminaire encastrable; plastique, nickel mat

Ø 78, ET 35

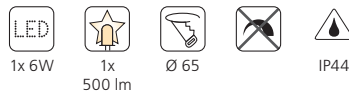

Ø 78

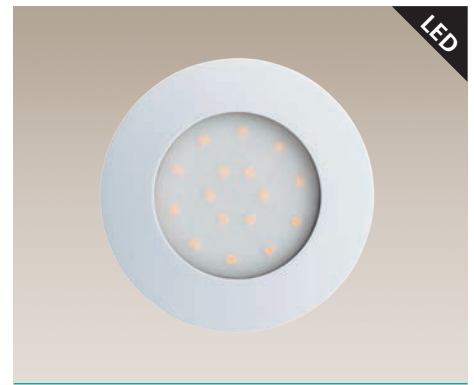

### 96416 PINEDA-IP

recessed luminaire; plastic, white  
 Einbauleuchte; Kunststoff, weiss  
 luminaire encastrable; plastique, blanc

Ø 102, ET 35

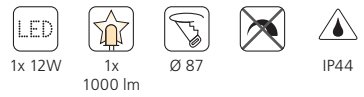

Ø 102



### 94092 MARGO

recessed luminaire; cast aluminium, stainless steel /  
 satinated glass, white  
 Einbauleuchte; Aluguss, edelstahl / Glas satiniert, weiss  
 luminaire encastrable; aluminium moulé, acier inoxydable /  
 verre satiné, blanc

H 10, Ø 84, ET 125

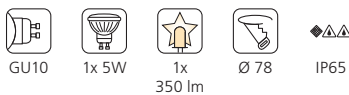

Ø 84



### 94093 MARGO

recessed luminaire; cast aluminium, white /  
 satinated glass, white  
 Einbauleuchte; Aluguss, weiss / Glas satiniert, weiss  
 luminaire encastrable; aluminium moulé, blanc /  
 verre satiné, blanc

H 10, Ø 84, ET 125



Ø 84



### 96417 PINEDA-IP

recessed luminaire; plastic, satin nickel  
 Einbauleuchte; Kunststoff, nickel-matt  
 luminaire encastrable; plastique, nickel mat

Ø 102, ET 35



Ø 102



180°, 12 m  
10 - 900 sec.

### 96452 DETECT ME 1

accessory; plastic, white  
Zubehör; Kunststoff, weiss  
accessoire; plastique, blanc

L 55, H 70, A 80



IP44



9 002759 964528



180°, 12 m  
10 - 900 sec.

### 96455 DETECT ME 2

accessory; plastic, white  
Zubehör; Kunststoff, weiss  
accessoire; plastique, blanc

L 80, H 50, A 115



IP44



9 002759 964559

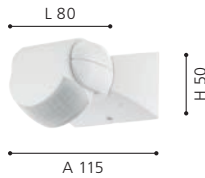

180°, 12 m  
10 - 420 sec.

### 96457 DETECT ME 3

accessory; plastic, white  
Zubehör; Kunststoff, weiss  
accessoire; plastique, blanc

L 75, H 120, A 70



IP44



9 002759 964573



180°, 12 m  
10 - 900 sec.

### 96454 DETECT ME 1

accessory; plastic, black  
Zubehör; Kunststoff, schwarz  
accessoire; plastique, noir

L 55, H 70, A 80



IP44



9 002759 964542

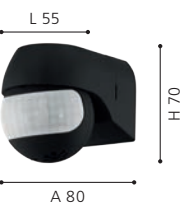

180°, 12 m  
10 - 900 sec.

### 96456 DETECT ME 2

accessory; plastic, black  
Zubehör; Kunststoff, schwarz  
accessoire; plastique, noir

L 80, H 50, A 115



IP44



9 002759 964566

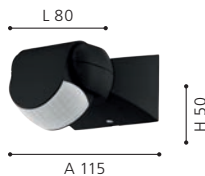

180°, 12 m  
10 - 420 sec.

### 96458 DETECT ME 3

accessory; plastic, silver  
Zubehör; Kunststoff, silber  
accessoire; plastique, argent

L 75, H 120, A 70



IP44



9 002759 964580





2000 lux



360°, 12 m  
10 - 900 sec.

### 96459 DETECT ME 4

accessory; plastic, white  
Zubehör; Kunststoff, weiss  
accessoire; plastique, blanc

L 60, H 80, A 120



IP44



2000 lux



360°, 12 m  
10 - 900 sec.

### 96462 DETECT ME 4

accessory; plastic, black  
Zubehör; Kunststoff, schwarz  
accessoire; plastique, noir

L 60, H 80, A 120



IP44



DETECT ME 1



DETECT ME 2



DETECT ME 3



DETECT ME 4



Accessories incl.  
Zubehör inkl.  
Accessoires  
inclus



	DETECT ME 1	DETECT ME 2	DETECT ME 3	DETECT ME 4
MOUNT ON CEILING				•
MOUNT ON WALL	•	•	•	•
MOUNT IN CORNER			•	•
MOUNT ON CORNER				•
Accessories incl. Zubehör inkl. Accessoires inclus				
				included see page 139
	10 sec. - 15 min.	10 sec. - 15 min.	10 sec. - 7 min.	10 sec. - 15 min.
	12 m	12 m	12 m	12 m
	180°	180°	180°	360°
	+/- 40° horizontal 45° horizontal	+/- 30° horizontal +/- 90° vertical		
	3 - 2000lx	3 - 2000lx	3 - 2000lx	3 - 2000lx
	max. 800 W incandescent max. 400 W flourescent	max. 1200 W incandescent max. 300 W flourescent	max. 1200 W incandescent max. 300 W flourescent	max. 1200 W incandescent max. 300 W flourescent

Ideal mounting height / Ideale Montagehöhe / Hauteur de montage ideale: ~ 2m



### 90748 PARK 4

accessory; stainless steel, stainless steel / plastic, green  
Zubehör; Edelstahl, edelstahl / Kunststoff, grün  
accessoire; acier inoxydable, acier inoxydable / plastique, vert

L 115, B 115, H 400, Base: B 160, T 160



IP44



9 002759 907488

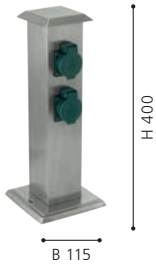

H 400

B 115



### 93426 PARK 4

accessory; steel, plastic, black  
Zubehör; Stahl, Kunststoff, schwarz  
accessoire; acier, plastique, noir

L 115, B 115, H 400, Base: B 160, T 160



IP44



9 002759 934262



H 400

B 115



### 91206 CONNECTOR BOX

accessory; plastic, black  
Zubehör; Kunststoff, schwarz  
accessoire; plastique, noir

H 50, Ø 155



IP68



9 002759 912062

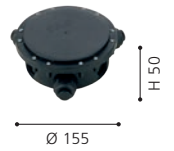

H 50

Ø 155

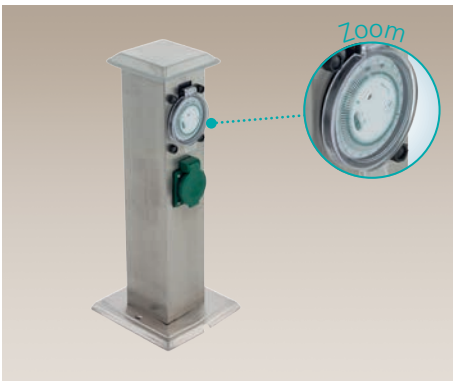

### 96351 PARK T

accessory; stainless steel, stainless steel / plastic, green  
Zubehör; Edelstahl, edelstahl / Kunststoff, grün  
accessoire; acier inoxydable, acier inoxydable / plastique, vert

L 115, B 115, H 400, Base: B 160, T 160



IP44



9 002759 963514



H 400

L 115

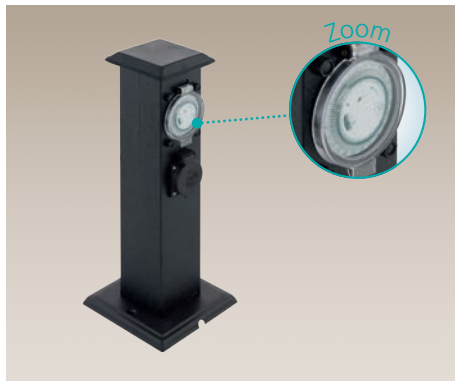

### 96352 PARK T

accessory; steel, plastic, black  
Zubehör; Stahl, Kunststoff, schwarz  
accessoire; acier, plastique, noir

L 115, B 115, H 400, Base: B 160, T 160



IP44



9 002759 963521



H 400

L 115



### 91207 CONNECTOR BOX

accessory; plastic, black  
Zubehör; Kunststoff, schwarz  
accessoire; plastique, noir

H 50, Ø 155



IP68



9 002759 912079

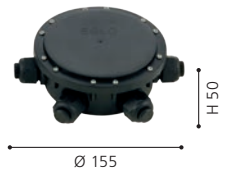

H 50

Ø 155



**88744**

With the CUBA ground spike you can stick your floor luminaire in the ground or set it in concrete.

Mit dem CUBA Erdspieß können Sie Ihre Stehleuchte in den Boden stecken oder einbetonieren.

Avec le piquet de terre CUBA vous pouvez fixer votre lampadaire en sol ou au béton.



**88152, 88153, 94112**

The above mentioned pictogram indicates suitable luminaires which can be easily mounted on corners with this accessories.

Das oben gezeigte Piktogramm markiert passende Leuchten, welche mit dem Zubehör einfach an Ecken montiert werden können.

Le pictogramme ci-dessus marque les luminaires correspondant, qui peut être monté avec les accessoires simples dans les coins.

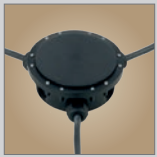

No more annoying cables in your garden: bury them simply and safely with the CONNECTOR BOX.

**91206:** 1 supply line and 2 distribution lines

**91207:** 1 supply line and 5 distribution lines

Mit der CONNECTOR BOX können Sie störende Kabel einfach und sicher unter der Erde verschwinden lassen.

**91206:** 1 Zuleitung und 2 Verteilungsleitungen

**91207:** 1 Zuleitung und 5 Verteilungsleitungen

Tous les câbles incommodes disparaissent simplement et sûrement dans votre jardin avec CONNECTOR BOX.

**91206:** 1 alimentation et 2 lignes de distribution

**91207:** 1 alimentation et 5 lignes de distribution



**96352, 96351**

The Socket „Park T“ is equipped with a timer.

Die Steckdosensäule „Park T“ ist mit einer Zeitschaltuhr ausgestattet.

La colonne de sortie du „Parc T“ est équipé d'une minuterie.

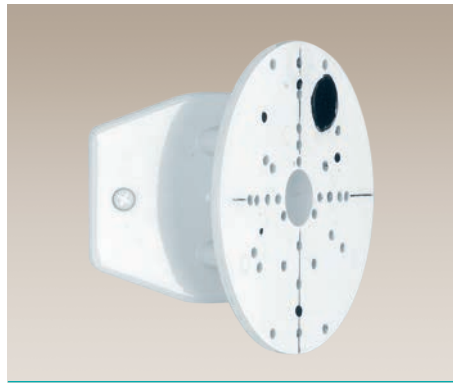

**88152**

accessory; steel, white

Zubehör; Stahl, weiss

accessoire; acier, blanc

Ø 112



9 002759 881528



Ø 112

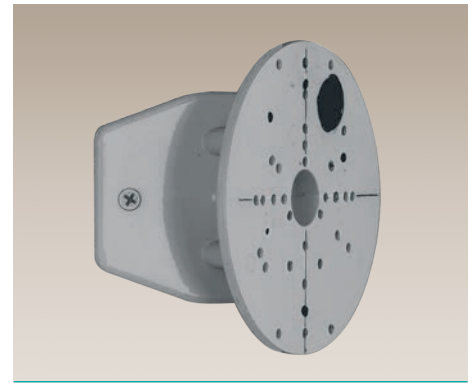

**94112**

accessory; steel, silver

Zubehör; Stahl, silber

accessoire; acier, argent

Ø 112



9 002759 941123



Ø 112



**88744 CUBA**

ground spike; steel, hot-dip galvanised

Erdspieß; Stahl, feuerverzinkt

acier, galvanisé à chaud

H 300, Ø 185



8x



9 002759 887445

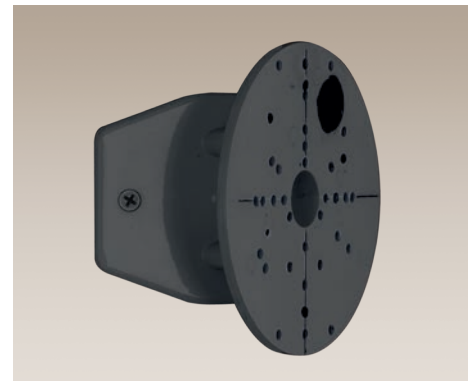

**88153**

accessory; steel, black

Zubehör; Stahl, schwarz

accessoire; acier, noir

Ø 112



9 002759 881535



Ø 112



Garden Living

Übersicht  
Overview  
Aperçu



LORENA  
p. 134



LORENA 1  
p. 134



TERRICO  
p. 136



TERRICO  
p. 136



TERRICO  
p. 136



FERROTERRA  
p. 137



TERRENO  
p. 137



### 89326 LORENA 1

floor luminaire; galvanized steel, antique brown / glass, champagne  
 Stehleuchte; Stahl verzinkt, antik-braun / Glas, champagner  
 lampadaire; acier galvanisé, marron antique / verre, champagne

H 580, Ø 215, Base: Ø 180

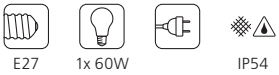

E27 1x 60W IP54



9 002759 893262



### 89173 LORENA

floor luminaire; galvanized steel, antique brown / opal glass, white  
 Stehleuchte; Stahl verzinkt, antik-braun / Glas opal-matt, weiss  
 lampadaire; acier galvanisé, marron antique / verre opale, blanc

H 1130, Ø 600, Base: Ø 250

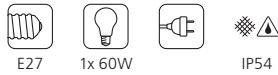

E27 1x 60W IP54



9 002759 891732







### 94335 TERRICO

floor luminaire; galvanized steel, black / satinated glass, white  
 Stehleuchte; Stahl verzinkt, schwarz / Glas satiniert, weiss  
 lampadaire; acier galvanisé, noir / verre satiné, blanc

### 94333 TERRICO

floor luminaire; galvanized steel, black / satinated glass, white  
 Stehleuchte; Stahl verzinkt, schwarz / Glas satiniert, weiss  
 lampadaire; acier galvanisé, noir / verre satiné, blanc

### 94332 TERRICO

floor luminaire; galvanized steel, brown / satinated glass, white  
 Stehleuchte; Stahl verzinkt, braun / Glas satiniert, weiss  
 lampadaire; acier galvanisé, marron / verre satiné, blanc

H 310, Ø 315, Base: Ø 230

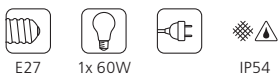

H 580, Ø 305, Base: Ø 230

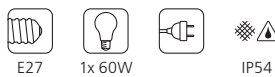

H 750, Ø 230, Base: Ø 230

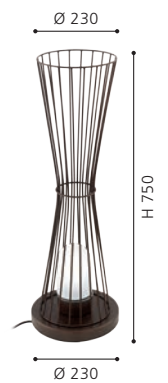
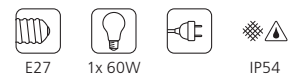



### 89565 FERROTERRA

floor luminaire; galvanized steel, black, patina silver / opal glass, white

Stehleuchte; Stahl verzinkt, schwarz, silber-patina / Glas opal-matt, weiss

lampadaire; acier galvanisé, noir, argent patiné / verre opale, blanc

H 450, Ø 452, Base: Ø 195



E27



1x 60W



IP54



9 002759 895655

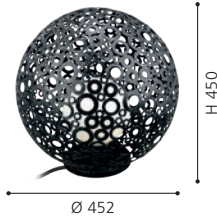

### 91436 TERRENO

floor luminaire; galvanized steel, black, patina silver / opal glass, white

Stehleuchte; Stahl verzinkt, schwarz, silber-patina / Glas opal-matt, weiss

lampadaire; acier galvanisé, noir, argent patiné / verre opale, blanc

H 900, Ø 380



E27



1x 60W



IP54



9 002759 914363



# Legend

## SENSOR SENSOR SENSOR

This symbol indicates luminaires with a sensor. In addition the sensor angle, sensor distance and lighting durance (min./max.) is indicated.

Ist die Leuchte mit einem Sensor ausgestattet, wird dies durch ein Sensorsymbol gekennzeichnet. Zusätzlich werden Ausstrahlungswinkel, Sensorreichweite und Einschaltsdauer (max./min.) angegeben.

Un produit avec cette symbole ont un détecteur de mouvement. Aussi le angle d'émission, la portée et la durée sont indiqué.

## ARTICLE NUMBER ARTIKELNUMMER NUMÉRO D'ARTICLE

## DESCRIPTION BESCHREIBUNG DESCRIPTION

The product description is composed as follows: luminaire type; enclosure material, enclosure colour / glass or shade material, glass or shade colour

Die Produktbeschreibung setzt sich wie folgt zusammen: Leuchtenart; Gehäusematerial, Gehäusefarbe / Schirm- bzw. Glasmaterial, Schirm- bzw. Glasfarbe

La description du produit est composée comme suit: type de luminaire; matériel de boîtier, couleur de boîtier / matériel de verre ou abat-jour, couleur de verre ou abat-jour

## DIMENSIONS DIMENSIONEN DIMENSIONS

all dimensions in mm | alle Größen in mm | toutes dimensions en mm

L = length | Länge | longueur  
B = width | Breite | largeur  
H = height | Höhe | hauteur  
Ø = diameter | Durchmesser | diamètre  
A = projection length | Ausladung | amplitude  
ET = installation depth | Einbautiefe | profondeur utile  
Base = base dimensions | Sockelmaße | dimensions de base

Attention! The dimensions relate solely to the sizes of the luminaire. Any air spaces that would be relevant for a safe operating of the lamp were not considered.

Achtung! Die Größen beziehen sich nur auf die Abmessungen der Leuchte. Etwaige Lufträume, die für einen sicheren Betrieb der Leuchte notwendig sind, werden nicht berücksichtigt.

Attention! Les dimensions se réfèrent à la taille de la lampe seulement. Espacements éventuels, que seraient importants pour une opération de la lampe sans danger, n'ont pas été considérés.

## PICTOGRAMMES PIKTOGRAMME PICTOGRAMMES

Technical details are represented as pictogrammes. An overview over all pictograms can be found on the next pages.

Technische Details werden als Piktogramme dargestellt. Eine Übersicht über alle Piktogramme finden Sie auf den nächsten Seiten.

Les détails techniques sont représentés sous forme de pictogrammes. Vous trouverez un aperçu de tous les pictogrammes dans les pages suivantes.



## SPARE PARTS ERSATZTEILE PARTS DE REMPLACEMENT

If a product has spare parts they are marked on the photograph with their corresponding article number.

Wenn zu einem Produkt Ersatzteile vorhanden sind, werden diese in der Abbildung mit deren Artikelnummer markiert.

Si un produit a des parts de remplacement, elles sont marquées dans la photo.

## CAMERA KAMERA CAMÉRA

A product with the camera symbol is separately shown in an ambience picture.

Ein Produkt mit dem Kamerasymbol ist separat in einem Ambientebild abgebildet.

Un produit avec le symbole de caméra est représenté séparément dans une image d'ambiance.

## SERIES NAME SERIENNAME NOM DE LA SÉRIE

## SKETCHES SKIZZEN CROQUIS

The sketches state the most meaningful dimensions. If a product is adjustable by will, a turquoise arrow marks this function and only the maximum dimensions are indicated.

Die Bemessung der Skizzen umfasst jeweils die aussagekräftigsten Größen. Bei verstellbaren Produkten kennzeichnet ein türkiser Pfeil diese Funktion und nur die maximalen Größen werden angegeben.

Les dimensions des croquis comprennent les plus représentatives. Si un produit est réglable au choix, une flèche turquoise affiche cette fonction et rien que les dimensions maximales sont indiquées.

## BUTTONS BUTTONS BOUTTONS

LED colour | LED Farbe | couleur de LED



EEL bulbs not included | Leuchtmittel exklusive | ampoules non comprises



EEL bulbs included | Leuchtmittel inklusive | ampoules comprises



EEL Erklärung | Description | Description

p.838-839

Colour Rendering Index | Farbwiedergabeindex | Indice de rendu de couleur de LED

**CRI**

CRI Erklärung | Description | Description

p.507

## SWITCHES

### SCHALTER

#### INTERRUPTEURS



**internal dimmer**  
eingebauter Dimmer  
variateur intégré



**rocker switch**  
Wippschalter  
interrupteur à bascule



**pull switch**  
Zugschalter  
interrupteur à tirer



**pedal switch**  
Trittschalter  
interrupteur à pied



**pedal dimmer**  
Trittdimmer  
variateur à pied



**button switch**  
Druckknopf  
interrupteur de pression



**cable switch**  
Kabelschalter  
interrupteur à câble



**sensor**  
Sensor  
sensor



**The day and night sensor switches the light on and off for you, starting with the twilight threshold you set.**

Der Day and night-Sensor schaltet für Sie das Licht an bzw. aus und das ab der von Ihnen eingestellten Dämmerungsschwelle.

Les commutateurs de jour et de capteurs de nuit pour éteindre les lumières ou désactiver, et votre seuil ensemble crépusculaire.



**remote control**  
Fernbedienung  
télécommande



**This luminaire can be switched on/off and dimmed by touching the specially designed "Touch Me" part of the fixture.**

Diese Leuchte kann ein- bzw. ausgeschaltet und gedimmt werden, indem man sie an den dafür vorgesehenen „Touch Me“ Bereichen berührt.

Ce luminaire peut être éteint, allumé et gradué simplement en touchant la partie spécialement conçue pour «Touch Me» du luminaire.



**The different lighting atmospheres can be adjusted with a conventional light switch. By pressing the switch in quick succession the luminaire changes between the different atmospheres (see below), by pressing the switch slowly the luminaire turns on or off. The last setting will then be saved.**

Die unterschiedlichen Lichtstimmungen der Leuchte können mit einem herkömmlichen Lichtschalter bedient werden. Durch schnelles Betätigen des Schalters wechselt die Leuchte zwischen den Einstellungen (siehe unten), langsames Drücken schaltet die Leuchte ein bzw. aus. Dabei wird die letzte Einstellung gespeichert.

Les ambiances lumineuses de la lampe peuvent être réglées avec un interrupteur conventionnel. Si l'interrupteur est actionné rapidement, la lampe change entre les ambiances différentes (voir ci-dessous); s'il est actionné lentement, la lampe est éteinte ou allumée. La dernière préférence sera mémorisée.



1x

2x

3x

4x

## PROTECTION CLASS

### SCHUTZKLASSE

#### CLASSE DE PROTECTION

The protection class indicates to what extent the lamp is protected against electric shock. All lamps in this catalogue are at least protected with the protection class 1 - a higher class is specified in the information box of the respective lamp.

Die Schutzklasse gibt an, inwiefern ein Produkt gegen einen elektrischen Schlag gesichert ist. Alle Leuchten in diesem Katalog sind mit mindestens Schutzklasse 1 gesichert, bei höheren Klassen wird das Symbol im Infokasten der Leuchte angegeben.

La classe de protection indique, dans quelle mesure la lampe est protégée contre les chocs électriques. Tous les lampes dans ce catalogue sont protégées au moins avec la classe 1 - une classe plus élevée est indiquée dans l'information de la lampe.



**protection class 1: protective earthing**

Schutzklasse 1: Schutzerdung  
classe de protection 1: prise de terre



**protection class 2: protective insulation**

Schutzklasse 2: Schutzisolierung  
classe de protection 2: double isolation ou renforcée



**protection class 3: protective low voltage**

Schutzklasse 3: Schutzkleinspannung  
classe de protection 3: très basse tension de sécurité

## PROTECTION RATING

### SCHUTZGRAD

#### INDICE DE PROTECTION

The protection rating ensures the operational safety of luminaires. The first number specifies the extent of the protection against the ingress of foreign bodies; the second number identifies the humidity protection grade. All luminaires in this catalogue are at least protected with the rating IP20 - a higher rating is specified in the information box of the luminaire.

Der Schutzgrad gewährleistet die Betriebssicherheit von Leuchten. Die erste Ziffer des IP Grades beschreibt den Schutzzumfang gegen das Eindringen von Fremdkörpern, die zweite Ziffer informiert über den Grad des Feuchtigkeitsschutzes. Alle Leuchten in diesem Katalog sind mit mindestens Schutzgrad IP20 gesichert, bei höheren Graden wird das Symbol im Infokasten der Leuchte angegeben.

L'indice de protection assure la sécurité opérationnelle des luminaires. Le premier chiffre indique à quel point la protection est efficace contre l'insertion de corps étrangers; le second chiffre indique quant à lui le degré de protection par rapport à l'humidité. Tous les luminaires dans ce catalogue sont protégés au moins avec l'indice IP20 - un indice plus élevé est indiqué dans l'information d'article.



IP33



IP44



IP54



IP65



IP67; IP68

## LUMINOUS COLOUR / FLUX

### LICHTFARBE / -STROM

#### COULEUR / FLUX LUMINEUX

The colours of the LED are represented as pictograms (see below), their luminous flux directly beneath. The luminous flux is quoted in lumen and describes the amount of light generated by the LED. The higher the value, the brighter is the lamp.

Die Farben der LED werden als Piktogramm (siehe unten) dargestellt, deren Lichtstrom direkt darunter. Der Lichtstrom wird in Lumen gemessen und gibt die erzeugte Lichtmenge der LED an. Je höher der Wert, desto heller das Produkt.

Les couleurs de LED ont représentés sous forme de pictogrammes, leur flux lumineux directement en dessous. L'unité de flux lumineux est le lumen et il mesure la quantité de lumière générée par les LED. Plus la valeur est élevée, plus la lampe est lumineuse.



**warm white (< 3300K)**

warmweiß (< 3300K)  
blanc chaud (< 3300K)



**neutral white (3300K - 5300K)**

neutralweiß (3300K - 5300K)  
blanc neutre (3300K - 5300K)



**cold white (> 5300K)**

kaltweiß (> 5300K)  
blanc froid (> 5300K)



**colour changing**

farbwechselnd  
changeant de couleur



**blue**

blau  
bleu



**tunable white**

tunable white  
tunable white

## FURTHER PICTOGRAMMES

### WEITERE PIKTORAMME

#### AUTRES PICTOGRAMMES



**replaceable LED**

austauschbare LED  
LED remplaçables



**dimmable**

dimmbar  
graduable



**not dimmable**

nicht dimmbar  
ne pas graduable



**corner mounting possible (accessory p. 112)**

Eckmontage möglich (Zubehör S. 112)  
montage dans le coin possible (accessoire p. 112)



**incl. cable & plug**

inkl. Kabel & Stecker  
incl. câble & connecteur



**maximum allowable load**

maximal zulässige Belastung  
charge maximale admissible



**cutout (in mm)**

Ausschnitt (in mm)  
perçage du panneau (en mm)



**packaging / delivery unit**



















Verpackungs- / Liefereinheit  
unité d'emballage / de livraison

# Legend



## SOCKETS FASSUNGEN DOUILLES

 2GX13	 E14	 E27	 G4	 G5
 G9	 GU5,3	 GU10	 GX53	 R7S
 LED				

## LED LAMPS LED LAMPEN LAMPES LED

 E14 C35 LED E14	 E14 C35 FILA E14	 E14 C35 TIP LED E14	 E14 C35 TIP FILA E14	 E14 G45 LED E14
 E14 G45 FILA E27	 E14 R50 LED E14	 E27 G45 LED E27	 E27 G45 FILA E27	 E27 G90 LED E27
 E27 G95 FILA E27	 E27 A60 LED E27	 E27 A60 FILA E27	 E27 R63 LED E27	 G4 LED G4
 G9 LED G9	 MR16 LED GU5,3	 GU10 LED GU10	 GX53 LED GX53	





## FLUORESCENT LAMPS LEUCHTSTOFFLAMPEN LAMPES FLUORESCENTES

 E27 G100 CFL E27	 T5 TUBE G5	 T5 RING 2GX13
---	--	---

## HALOGEN LAMPS HALOGENLAMPEN LAMPES HALOGÈNES

 E14 C35 ECO E14	 E14 G45 ECO E14	 E27 A55 ECO E27	 E27 R63 ECO E27	 G4 G4
 G9 G9	 MR16 GU5,3	 GU10 GU10	 GY6,35 GY6,35	 R7S R7S

## INCANDESCENT LAMPS ALLGEBRAUCHSLAMPEN LAMPES À INCANDESCENCE

 E14 C35 E14	 E14 C35 TIP E14	 E14 G45 E14	 E27 A60 E27	 E14 R50 E14
--	---	---	---	---

# Memo

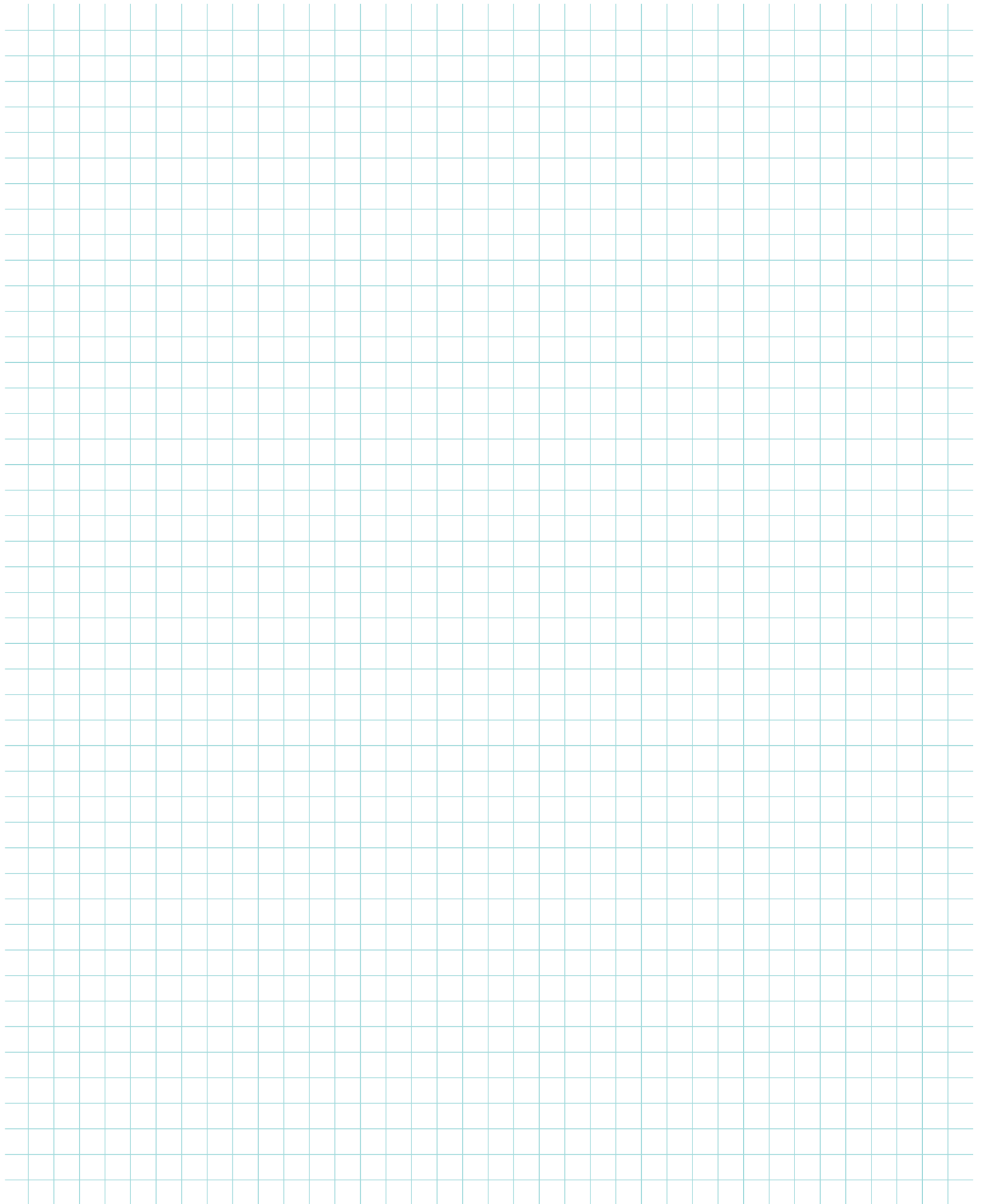

# Register

NAME NAME NOM	PAGE SEITE PAGE	NAME NAME NOM	PAGE SEITE PAGE	NAME NAME NOM	PAGE SEITE PAGE	NAME NAME NOM	PAGE SEITE PAGE
ACATE	47	FAEDO 1	122-123	ONCALA	42	TABO-LED	44
AGOLADA	20	FAEDO 2	121	ONJA	62	TERRENO	137
ALAMONTE	72	FAEDO 2	121	ONTANEDA	60	TERRICO	136
ALAMONTE 1	74	FERROTERRA	137	OROPOS	43	TOLLERA	88
ALAMONTE 2	92	HELSINKI	26-27	OUTDOOR CLASSIC	116-117	TRABADA	58
ALBACETE	88	HILBURN	78	PARDELA 1	44	TRONO 2	20
ALORIA	94-95,98-99	HILBURN 1	76	PARK	50	TRONO STICK	20
ANOLA	65	INFESTO	52	PARK 4	130	VALDEO	90
APIMARE	90	INFESTO 1	52	PARK T	130	VENTO 1	60
APIMARE	90	ISOBA	62,92	PENALVA	16	VENTO 2	60
ARCHA	57	JORBA	38	PENALVA 1	16-17	VOLPINO	43
ARGOLIS	53,60	JORBA	38	PERAFITA	39	ZAMORANA	46
ASCOLI	25	KIBEA	48	PIAS	44	ZIMBA	124
ATOLLARI	34	KONYA	32	PINEDA-IP	127	ZIMBA-LED	124
BARROSELA	76,86-87	LAMEDO	126	POLIENITO	14		
BASALGO 1	18	LATERNA 4	114-115	PREDAZZO	48		
BEVERLY	32	LATERNA 5	112-113	PULFERO	80		
BOSARO	37	LATERNA 7	107	PULFERO 1	82		
BREGANZO	50,92	LEPUS	66	RALORA	56		
BREGANZO 1	51	LISIO	100-101	RALORA 1	57		
CABOS	25	LORENA	134	RAVARINO	32		
CALGARY	31	LORENA 1	134	REDONDO	35		
CALGARY 1	44	LORMES	59	RIGA	24-25		
CERNO	56,138	MALGERA	50	RIGA 1	119-120		
CITY	55,66	MAMURRA	90	RIGA 3	126		
CITY 1	55	MARGO	127	RIGA-LED	22-23		
CITY LED	54	MELGOA	86-87	ROBLEDO	33		
COLINDRES	87	MILTON	66,102,105	ROFFIA	30		
COLINDRES 1	86	MINORCA	104	SAN TELMO	105		
COMIO	42	MINORCA	104	SERVOI	36		
COMUNERO	70	MONASTERIO	84	SESIMBA	40,92		
CONNECTOR BOX	130	MORINO	34	SESIMBA 1	40		
COVALE	36	MOUNA	102	SEVILIA	92		
CUBA	131	NABILA 1	105	SEVILLA	66		
DARIL	56	NADELA	48	SIDNEY	96		
DETECT ME 1	128	NAVEDO	106,108-110	SIONES 1	64		
DETECT ME 2	128	NAVEDO	106,108-110	SITIA	45		
DETECT ME 3	128	NEMA	119-120	SOJO	48		
DETECT ME 4		NEMA 1	119-120	SONELLA	52		
DUERO		NISIA	28	SONELLA 1	52		
ENTRIMO	66,88	NISIA 1	29	STOCKHOLM 1	25		
FACUNDA	88	OHIO	28	TABO	46		

NUMBER NUMMER NUMÉRO	PAGE SEITE PAGE	NUMBER NUMMER NUMÉRO	PAGE SEITE PAGE	NUMBER NUMMER NUMÉRO	PAGE SEITE PAGE	NUMBER NUMMER NUMÉRO	PAGE SEITE PAGE	NUMBER NUMMER NUMÉRO	PAGE SEITE PAGE	NUMBER NUMMER NUMÉRO	PAGE SEITE PAGE	NUMBER NUMMER NUMÉRO	PAGE SEITE PAGE
4171	116	86389	31	93367	35	94119	32	94842	78	95991	36	96416	127
4172	117	86541	32	93368	35	94121	60	94843	78	95992	36	96417	127
4173	117	87105	96	93369	44	94125	20	94844	78	96006	39	96452	128
4174	117	88008	124	93384	120	94127	20	94845	47	96007	39	96454	128
4175	117	88119	66	93385	120	94128	20	94848	40	96013	33	96455	128
5389	107	88139	55	93402	98	94133	50	94849	40	96014	33	96456	128
22144	114	88142	55	93403	99	94137	50	94851	46	96015	36	96457	128
22145	114	88144	55	93404	98	94138	50	94852	58	96016	36	96458	128
22462	113	88152	131	93405	98	94184	46	94853	58	96017	51	96459	129
22463	113	88153	131	93406	94	94185	46	94854	82	96018	51	96462	129
22464	113	88487	66	93407	95	94186	46	94855	82	96019	40	96491	60
22465	112	88489	66	93408	94	94212	54	94856	82	96021	40	96492	60
22466	112	88575	124	93409	94	94213	54	94857	82	96022	40	96494	53
22467	115	88744	131	93426	130	94277	18	94858	87	96206	66	96495	53
22468	115	88802	65	93438	48	94278	18	94859	76	96207	88	96504	23
22469	115	88803	65	93444	110	94279	18	94861	86	96222	90	96505	23
22471	114	88807	65	93445	110	94281	18	94862	86	96223	90	96583	59
22472	114	89173	134	93446	110	94332	136	94863	87	96232	90	96584	59
22995	112	89314	28	93447	110	94333	136	94864	78	96233	90		
22996	112	89326	134	93448	110	94335	136	94865	76	96234	88		
27126	28	89366	57	93451	110	94779	37	94866	76	96235	88		
30173	56	89533	104	93452	109	94784	60	94867	76	96236	88		
30181	102	89535	104	93453	109	94785	60	94868	76	96237	43		
30182	102	89536	104	93454	109	94786	72	94871	52	96238	43		
30183	102	89565	137	93455	106	94787	72	94872	52	96239	90		
30184	100	89767	62	93456	106	94788	74	94874	52	96241	90		
30185	101	89768	62	93457	106	94789	74	94876	52	96255	38		
30186	100	89769	62	93458	106	94792	86	94877	52	96256	38		
30187	100	90121	25	93459	106	94793	46	95016	14	96262	88		
30188	100	90184	105	93462	106	94794	46	95017	14	96263	88		
30191	56	90748	130	93463	108	94796	40	95018	14	96267	92		
30192	138	90867	66	93464	108	94797	56	95019	14	96268	92		
30193	55	91206	130	93465	108	94798	56	95073	58	96269	92		
30194	55	91207	130	93481	126	94802	20	95074	58	96271	92		
30205	28	91436	137	93482	126	94803	20	95233	124	96272	92		
30206	28	91769	43	93991	37	94804	20	95234	124	96273	92		
30207	28	92735	22	93993	48	94805	86	95235	124	96276	34		
81751	26	92736	22	93994	48	94807	105	95403	122	96277	34		
81752	26	92737	22	94086	56	94811	16	95404	122	96284	121		
81753	27	92738	22	94087	30	94812	16	95405	122	96285	121		
82309	55	93094	99	94088	30	94813	16	95406	123	96294	70		
83278	27	93095	99	94092	127	94817	16	95407	122	96295	70		
83279	26	93096	98	94093	127	94818	16	95408	122	96296	70		
83281	26	93097	95	94099	24	94819	17	95409	122	96297	70		
83432	50	93098	95	94101	24	94827	72	95411	123	96338	64		
83433	50	93099	94	94102	24	94828	72	95976	84	96339	64		
83588	102	93253	48	94103	24	94829	72	95977	84	96341	64		
83589	105	93254	48	94104	24	94831	74	95978	84	96342	64		
83966	96	93256	48	94105	24	94832	74	95979	84	96351	130		
83969	96	93268	25	94106	25	94833	74	95981	42	96352	130		
83971	96	93271	25	94107	25	94834	80	95982	42	96353	62		
86189	126	93318	34	94109	120	94835	80	95985	42	96354	62		
86248	32	93319	34	94111	120	94836	80	95986	42	96365	60		
86385	32	93364	44	94112	131	94837	87	95987	45	96402	102		
86387	31	93365	44	94114	44	94838	87	95988	45	96414	127		
86388	31	93366	29	94118	30	94841	80	95989	57	96415	127		

All previous catalogues and price lists are no longer valid with the issue of this catalogue. Errors, misprints, model and price changes and technical modifications are reserved. We deliver based on our terms of delivery and payment. Our products comply with the European light norm EN60598. Products with the ENEC test mark are conforming to the guide line 2006/95/EG. Products with additional safety remarks (e.g protection class, IP) are identified within the product family with the relevant symbol and number. The content of this catalogue is protected under copyright law for EGLO Leuchten GmbH. All rights reserved. Our specific written consent must be obtained before using any illustrations and texts. The pictures are 4C prints and may differ from the original.

The product pictures and ambiances in this catalogue can deviate from reality, and they do not necessarily concur with the usual application of the product. EGLO does not assume liability for the correctness, completeness or the application depiction of the products and/or the product information.

Design, layout and composition: EGLO GmbH, A-6136 Pill - AUSTRIA  
Print: Druckerei Berger, 3580 Horn, Austria  
Pictures: EGLO, fotolia.com, istockphoto.com

Mit diesem Katalog verlieren alle vorhergehenden Kataloge und Preislisten ihre Gültigkeit. Irrtümer, Druckfehler, Modell- und Preisänderungen sowie technische Änderungen vorbehalten. Wir liefern zu unseren Liefer- und Zahlungsbedingungen. Unsere Produkte entsprechen der europäischen Leuchtnorm EN 60598. Produkte mit dem ENEC Prüfzeichen sind konform mit der Richtlinie 2006/95/EG. Produkte mit weiteren Sicherheitshinweisen (zB. Schutzklasse, IP) sind mit Symbol und Zahl bei der Produktfamilie ausgezeichnet. Der Inhalt dieses Kataloges ist für die EGLO Leuchten GmbH urheberrechtlich geschützt. Alle Rechte sind vorbehalten. Bilder und Texte dürfen nicht ohne vorherige ausdrückliche, schriftliche Genehmigung verwendet werden. Die Abbildungen sind 4C Drucke und können vom Original abweichen.

Die Katalogbilder und die gezeigten Darstellungen der Produkte können von der Wirklichkeit abweichen und nicht den üblichen Produktanwendungen entsprechen. EGLO übernimmt keine Haftung für die Richtigkeit, Vollständigkeit und Anwendungsdarstellung der Produkte und Produktinformationen.

Gestaltung, Layout und Satz: EGLO GmbH, A-6136 Pill - AUSTRIA  
Druck: Druckerei Berger, 3580 Horn, Austria  
Bilder: EGLO, fotolia.com, istockphoto.com

Le présent catalogue remplace tous les catalogues et tarifs précédents. Sous réserve d'erreurs, de fautes d'impression, de modification des modèles et de changement de prix et de technique. Nous livrons sur la base de nos conditions de livraison et de paiement. Nos produits sont conformes aux normes européennes EN 60598 et portent le marquage CE. Les produits portant la marque ENEC sont conformes à la Directive 2006/95/EG. Les produits portant d'autres indications de sécurité (par exemple classe de protection, IP) sont identifiés par le symbole et le nombre correspondants dans la famille de produits.

Le contenu du présent catalogue est protégé pour la société EGLO Leuchten GmbH par un copyright. Tous droits réservés. Toute reproduction d'images et du texte est interdite sans autorisation explicite par écrit préalable. Les images sont imprimées en 4C et peuvent différer de l'original.

Les images des produits et les ambiances dans le catalogue peuvent dévier de la réalité et ne sont pas nécessairement en ligne avec l'usage habituel du produit. EGLO n'engage pas sa responsabilité sur la justesse des images et sur les informations relatives à l'usage pouvant être fait des produits.

Conception, maquette et composition: EGLO GmbH, A-6136 Pill - AUSTRIA  
Presse: Druckerei Berger, 3580 Horn, Austria  
Images: EGLO, fotolia.com, istockphoto.com

01-2017





EGLO Leuchten GmbH  
Heiligkreuz 22  
A-6136 Pill  
Austria  
Tel. +43 (0)5242 6996  
Fax +43 (0)5242 6996-938  
info@eglo.com  
www.eglo.com



[www.eglo.com](http://www.eglo.com)