

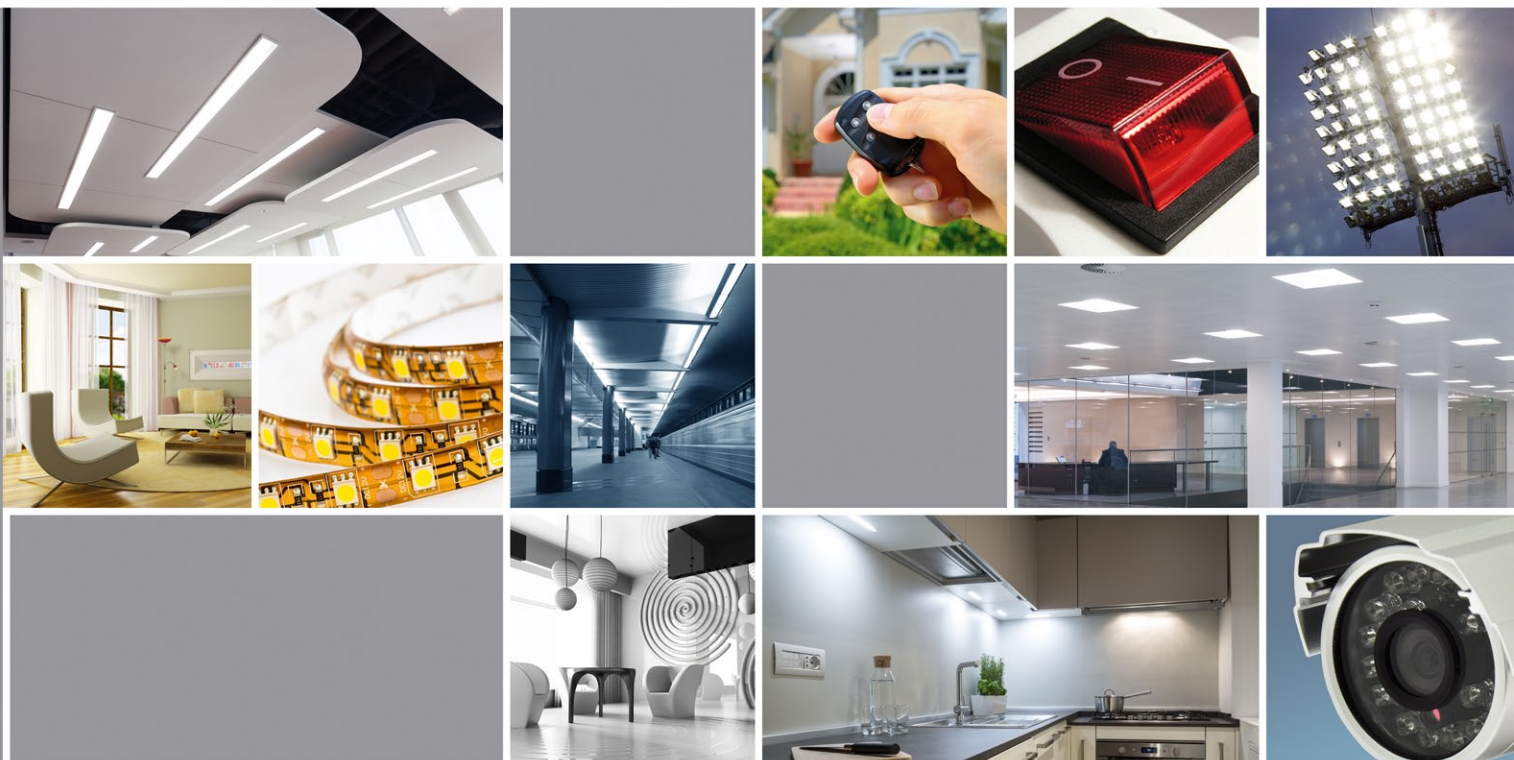

Ecolite



KATALOG 2016
svítidla & elektromateriál

light eco we



LED / zářivková svítidla
LED / žiarivkové svietidlá
opravy oświetleniowe

5 - 25



montážní lampy
montážne lampy
lampa montażowa

27 - 28

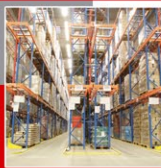

technická svítidla
technické svietidlá
opravy techniczne

29 - 48



reflektory
reflektory
lampy reflektorowe

49 - 64



světelné zdroje
svetelné zdroje
źródła światła

65 - 84



elektromateriál
elektromateriál
materiał elektryczny

85 - 104



zabezpečovací technika
zabezpečovacia technika
bezpieczeństwo technologia

105 - 115

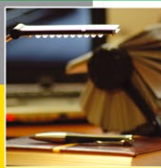

stolní lampy
stolné lampy
lampy stołowe

117 - 123



stojací lampy
stojanové lampy
lampy stojące

125 - 127



nástěnky
nástenky
kinkiety

129 - 130



lustry
lustre
lampy

131 - 134



venkovní světila
vonkajšie svetlá
lampy zewnętrzne

135 - 137

zářivková / LED tělesa
žiarivkové / LED telesá
opravy oświetleniowe



montážní lampy
montážne lampy
lampa montażowa



technická svítidla
technické svetidlá
opravy techniczne

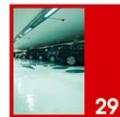

reflektory
reflektory
lampy reflektorowe

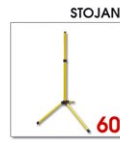

světelné zdroje
svetelné zdroje
źródła światła



elektromateriál
elektromateriál
materiał elektryczny



zabezpečovací technika
zabezpečovacia technika
bezpieczeństwo technologia





stolní lampy
stolné lampy
lampy stolowe



stojací lampy
stojanové lampy
lampy stojące



nástěny
nástenky
kinkiety



lustry
lustre
lampy



venkovní světla
vonkajšie svetlá
lampy zewnętrzne



ecolite



LED / zářivková svítidla
LED / žiarivkové svetidlá
oprawy oświetleniowe



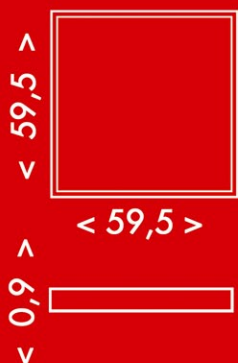
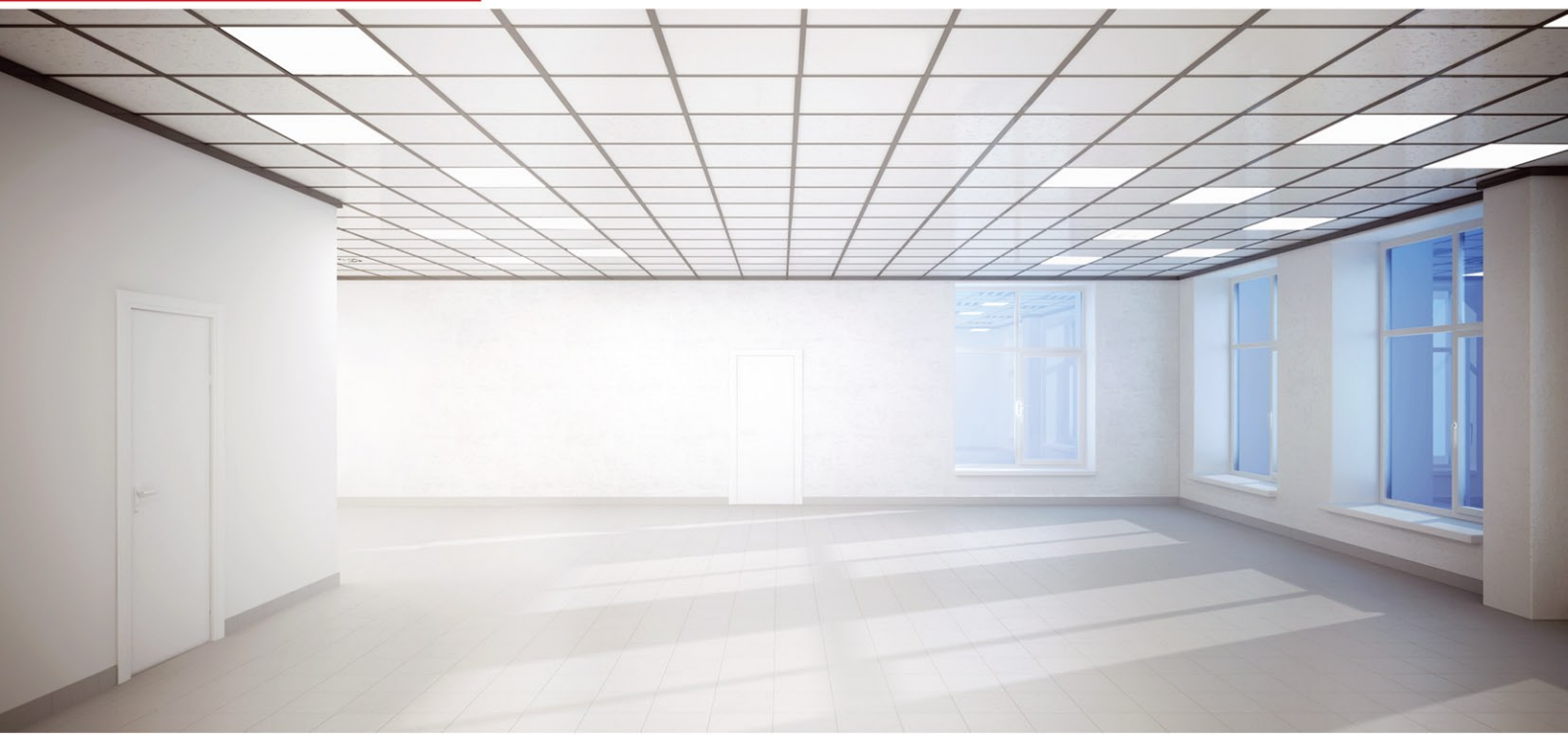

ecolite LED-GPL44-45

Toto svítidlo obsahuje světelné zdroje LED.

A+
A+
A
C
D
F

LED

Světelné zdroje LED v tomto svítidle nelze vyměnit.

874/2012



45W **3700lm**



LED-GPL44-45/3000



8 590 849 519044

45W **3800lm**



LED-GPL44-45



8 590 849 516821

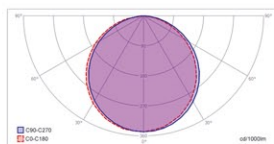

CE ~230V F LED 216x SMD 2835

max. 45W 140° IP20 30000h

3000K 4000K Ra ≥80

A1 5

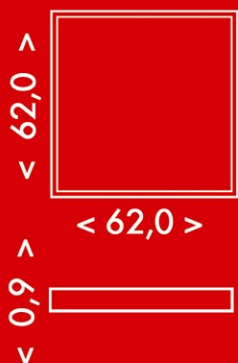

ecolite LED-GPL44-45

Toto svítidlo obsahuje světelné zdroje LED.

A+
A+
A
C
D
F

LED

Světelné zdroje LED v tomto svítidle nelze vyměnit.

874/2012



45W 3800lm



LED-GPL44-45/PD



8 590 849 5 168 38

60,5x60,5

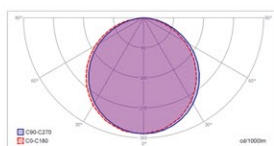

CE ~230V F LED 216x SMD 2835

max. 45W 140° IP20 30000h

4000K Ra ≥80

5

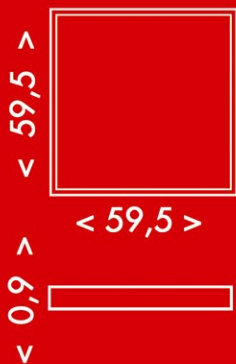

ecolite LED-GPL44-45

Toto svítidlo obsahuje světelné zdroje LED.

A++
A+
A
C
D
F

LED

Světelné zdroje LED v tomto svítidle nelze vyměnit.

874/2012



45W **3800lm**



LED-GPL44-45



LED-GPL44-RAM

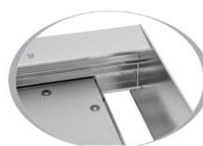
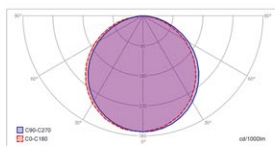

CE ~230V F LED 216x SMD 2835

max. 45W 140° IP20 30000h

4000K Ra ≥80

4

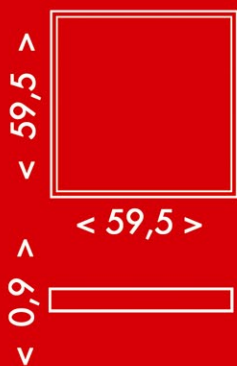

ecolite LED-GPL44-45

Toto svítidlo obsahuje světelné zdroje LED.

A+
A+
A
C
D
F

LED

Světelné zdroje LED v tomto svítidle nelze vyměnit.

874/2012



45W 3800lm



LED-GPL44-45



set 4ks



LED-GPL44-ZAVES

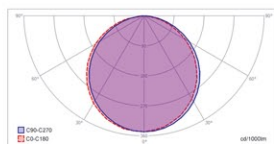
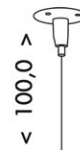

CE ~230V F LED 216x SMD 2835

max. 45W 140° IP20 30000h

4000K Ra ≥80

4



24W 29,5 x 59,5
75W 59,5 x 119,5



0,9

ecolite LED-GPL44

Toto svítidlo obsahuje světelné zdroje LED.

A++
A+
A
C
D
E

LED

Světelné zdroje LED v tomto svítidle nelze vyměnit.

874/2012

	~230V			120x SMD 2835
max. 24W	360x SMD 2835	max. 75W		
IP20	30000h	4000K	Ra ≥80	



24W **2100lm**
LED-GPL44-24



8 590 849 518 771

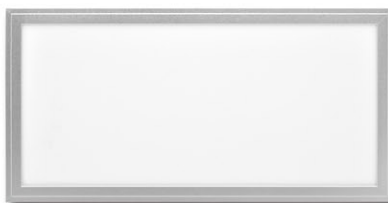

75W **6600lm**
LED-GPL44-75



8 590 849 518 795

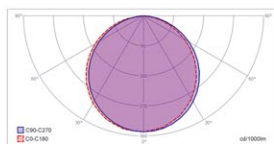

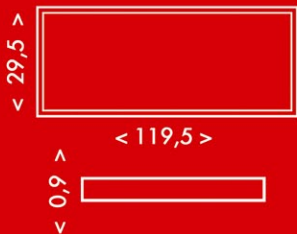

45W **3800lm**
LED-GPL44/B-45



ecolite LED-GPL44

Toto svítidlo obsahuje světelné zdroje LED.

A+
A+
A
C
D
F

LED

Světelné zdroje LED v tomto svítidle nelze vyměnit.

874/2012

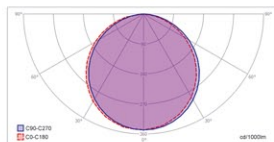

LED-GPL44-EM



pouze pro panely 45W

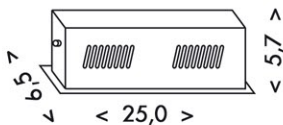

LITHIUM ACCU 7.4V 4.5Ah *max. 3h 760lm

216x SMD 2835
 max. 45W

 30000h
 4000K
 Ra ≥80

 5



LED / žárovková svítidla LED / žiarivkové svietidlá opravy osvetleniowe

LADA

A+

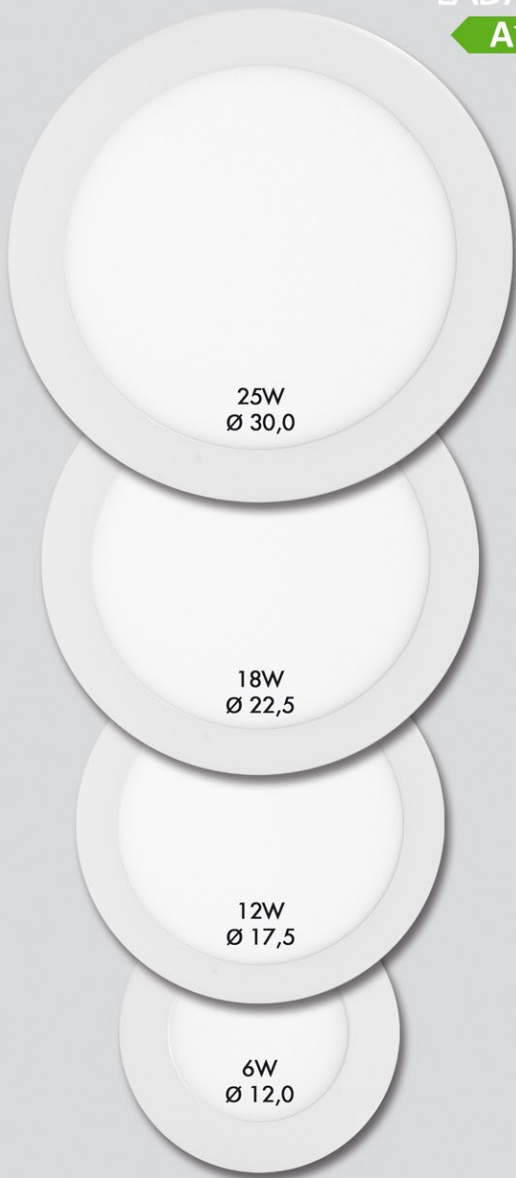

6W

420lm



LED-WSL-6W/2700

6W

440lm



LED-WSL-6W/4100

Ø 10,5

LED-WSL-6W/2700



8 590 849 512960

LED-WSL-6W/4100



8 590 849 512984

12W

860lm



LED-WSL-12W/2700

12W

880lm



LED-WSL-12W/4100

Ø 15,5

LED-WSL-12W/2700



8 590 849 513004

LED-WSL-12W/4100



8 590 849 513028

18W

1530lm



LED-WSL-18W/2700

18W

1550lm



LED-WSL-18W/4100

Ø 20,5

LED-WSL-18W/2700



8 590 849 513042

LED-WSL-18W/4100



8 590 849 513066

25W

2240lm



LED-WSL-25W/2700

25W

2260lm



LED-WSL-25W/4100

Ø 28,0

LED-WSL-25W/2700



8 590 849 513080

LED-WSL-25W/4100



8 590 849 513103





LED / žárovková svítidla LED / žiarivkové svetidlá opravy osvetleniowe

RAFA

A⁺

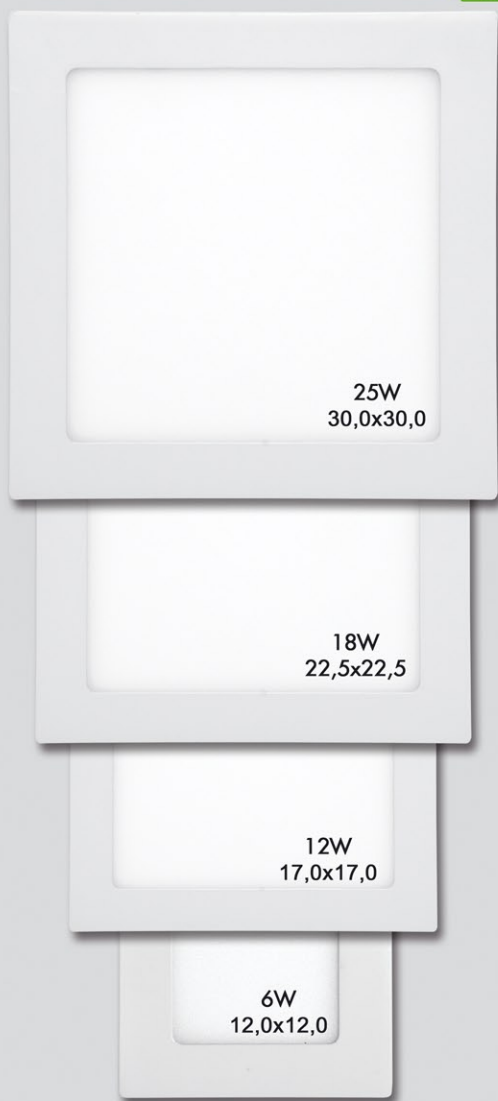

6W 420lm	6W 440lm	10,5x10,5	LED-WSQ-6W/2700	8 590 849 513 127	LED-WSQ-6W/4100	8 590 849 513 141
12W 860lm	12W 880lm	15,5x15,5	LED-WSQ-12W/2700	8 590 849 513 165	LED-WSQ-12W/4100	8 590 849 513 189
18W 1530lm	18W 1550lm	20,5x20,5	LED-WSQ-18W/2700	8 590 849 513 202	LED-WSQ-18W/4100	8 590 849 513 226
25W 2240lm	25W 2260lm	28,0x28,0	LED-WSQ-25W/2700	8 590 849 513 240	LED-WSQ-25W/4100	8 590 849 513 264



~230V max. 6W max. 12W max. 18W max. 25W 30000h 2700K 4100K
 5



LED / žárovková svítidla LED / žiarivkové svetidlá opravy oświetleniowe

NOVINKA

LADA
A+

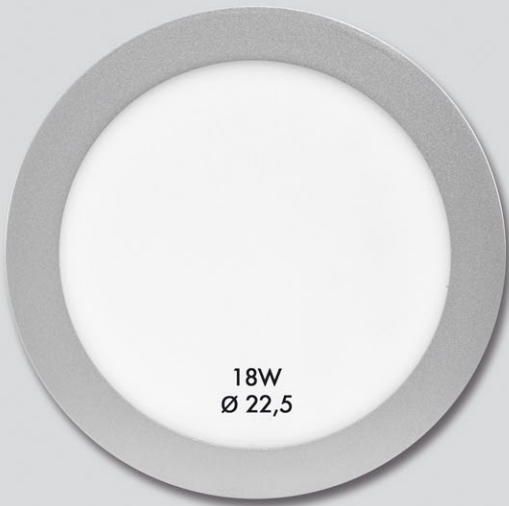

12W **860lm**



Ø 15,5

LED-WSL-12W/27/STR

12W **880lm**



Ø 15,5

LED-WSL-12W/41/STR

18W **1530lm**



Ø 20,5

LED-WSL-18W/27/STR

18W **1550lm**



Ø 20,5

LED-WSL-18W/41/STR

LED-WSL-12W/27/STR



LED-WSL-12W/41/STR



LED-WSL-18W/27/STR



LED-WSL-18W/41/STR

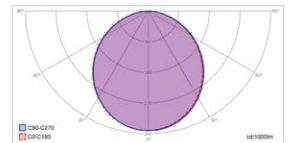

- CE
- ~230V
- F
- LED
- 60x SMD 2835
- 90x SMD 2835
- max. 12W
- max. 18W
- 140°
- IP20
- 30000h
- 2700K
- 4100K
- Ra ≥80
- House icon
- Grid icon
- LED icon





LED / žárovková svítidla LED / žiarivkové svetidlá opravy osvetleniowe

NOVINKA

RAFA

A+



12W **860lm**



15,5x15,5

LED-WSQ-12W/27/STR

LED-WSQ-12W/27/STR



LED-WSQ-12W/41/STR



12W **880lm**



15,5x15,5

LED-WSQ-12W/41/STR

LED-WSQ-18W/27/STR



18W **1530lm**



20,5x20,5

LED-WSQ-18W/27/STR

LED-WSQ-18W/41/STR



18W **1550lm**



20,5x20,5

LED-WSQ-18W/41/STR

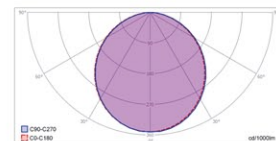
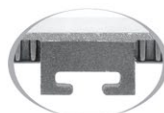

NOVINKA

LADA 2

A+

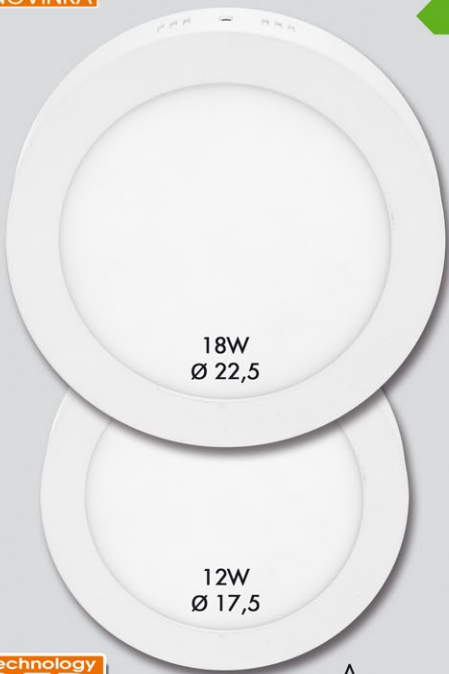

12W **860lm**



LED-CSL-12W/2700

12W **880lm**



LED-CSL-12W/4100

18W **1530lm**



LED-CSL-18W/2700

18W **1550lm**



LED-CSL-18W/4100



LED-CSL-12W/2700



LED-CSL-12W/4100



LED-CSL-18W/2700



LED-CSL-18W/4100



NOVINKA

RAFA 2

A+

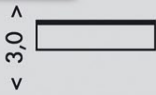

12W **860lm**



LED-CSQ-12W/2700

12W **880lm**



LED-CSQ-12W/4100

18W **1530lm**



LED-CSQ-18W/2700

18W **1550lm**



LED-CSQ-18W/4100



LED-CSQ-12W/2700



LED-CSQ-12W/4100



LED-CSQ-18W/2700



LED-CSQ-18W/4100





LED / žárovková svítidla
LED / žiarivkové svetidlá
opravy osvetleniowe

PROFIL



DX-AP05-PROFIL

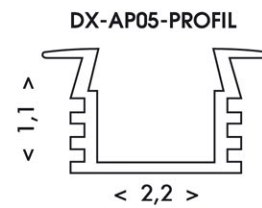

DX-AP05-PROFIL



DX-AP06-PROFIL



DX-AP06-PROFIL

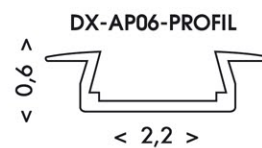

DX-AP07-PROFIL



DX-KRYT/CIR



DX-KRYT/ML



DX-AP05-END



DX-AP06/07-END



DX-KLIP



DX-AP07-PROFIL

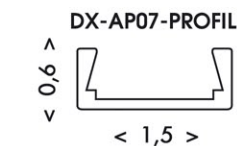

DX-KRYT/CIR



DX-KRYT/ML



DX-AP05-END



DX-AP06/07-END



DX-KLIP





LED / žárovková svítidla LED / žiarivkové svetidlá opravy osvetleniowe

NOVINKA
technology
LED

COB STRIP

A+

DX-COB6565-2700/25M



8 59 08 49 51 67 84

DX-COB6565-6000/25M



8 59 08 49 51 67 91

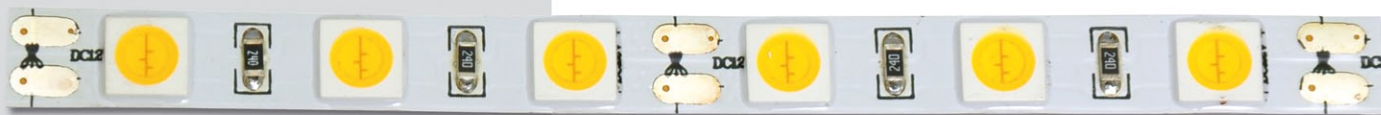

25m **1100lm/m**



DX-COB6565-2700/25M

25m **1200lm/m**



DX-COB6565-6000/25M



TRAFO



DX-WP-18W/IP67



DX-WP-30W/IP67



DX-WP-100W/IP67



DX-WP-150W/IP67



DX-WP-60W/IP67



DX-WP-200W/IP67

DX-WP-18W/IP67



DX-WP-30W/IP67



DX-WP-60W/IP67



DX-WP-100W/IP67



DX-WP-150W/IP67



DX-WP-200W/IP67



TRAFO SLIM



DX-WP-30W/SLIM

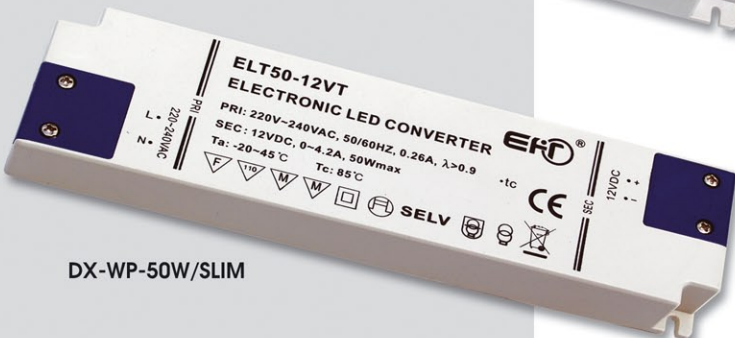

DX-WP-50W/SLIM

DX-WP-30W/SLIM



DX-WP-50W/SLIM





< 4,3 >
 < 2,2 >
 5W < 34,2 >
 8W < 57,3 >
 12W < 90,3 >

NOVINKA
 technology
LED



5W **450lm**



TL2001-28SMD/5W



8 590849 519792

8W **780lm**



TL2001-56SMD/8W



8 590849 519808

12W **1070lm**



TL2001-70SMD/12W



8 590849 519815

ecolite TL2001-SMD

Toto svítidlo obsahuje světelný zdroj LED.

A++
A+
A
C
D
E

LED

Světelný zdroj LED v tomto svítidle nelze vyměnit.

874/2012

CE	~230V	F	LED	28x SMD 2835
56x SMD 2835	70x SMD 2835	IP20		
30000h	4100K	Ra ≥80		
20	12W=10	10	12W=5	





5,5W 440lm

TL2016-28SMD/5,5W



10W 800lm

TL2016-42SMD/10W



15W 1200lm

TL2016-70SMD/15W



ecolite TL2016-SMD

Toto svítidlo obsahuje světelný zdroj LED.

A+ A A C D E } LED

Světelné zdroje LED v tomto svítidle nelze vyměnit.

874/2012

CE	~230V	F	LED	28x SMD 2835
42x SMD 2835	70x SMD 2835	IP20	30000h	
4100K	Ra ≥80	A		
12	3			

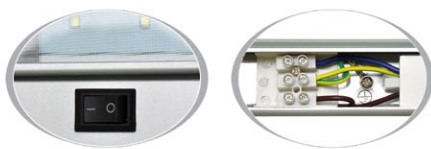



LED / žárovková svítidla LED / žiarivkové svietidlá opravy oświetleniowe

SLICK

A

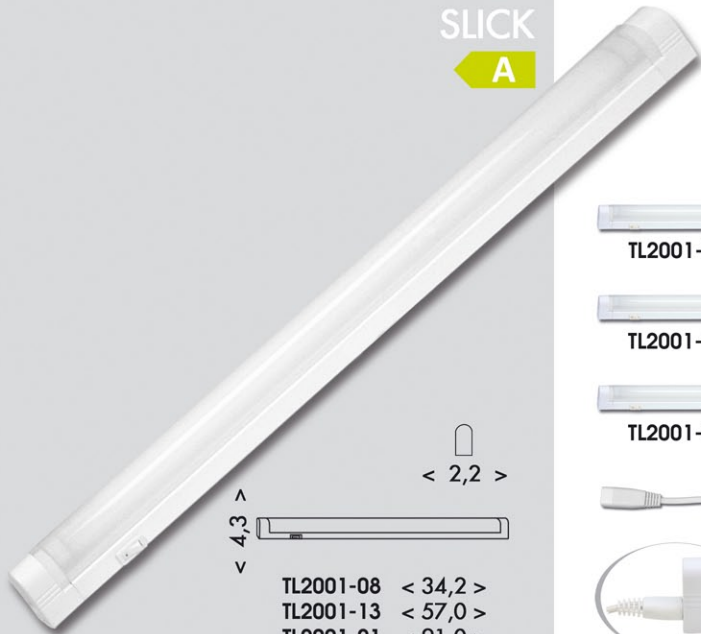

< 4,3 >
< 2,2 >
TL2001-08 < 34,2 >
TL2001-13 < 57,0 >
TL2001-21 < 91,0 >



TL2001-08



TL2001-13



TL2001-21

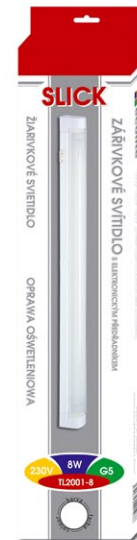

TL2001-08



TL2001-13



TL2001-21



SLICK

A

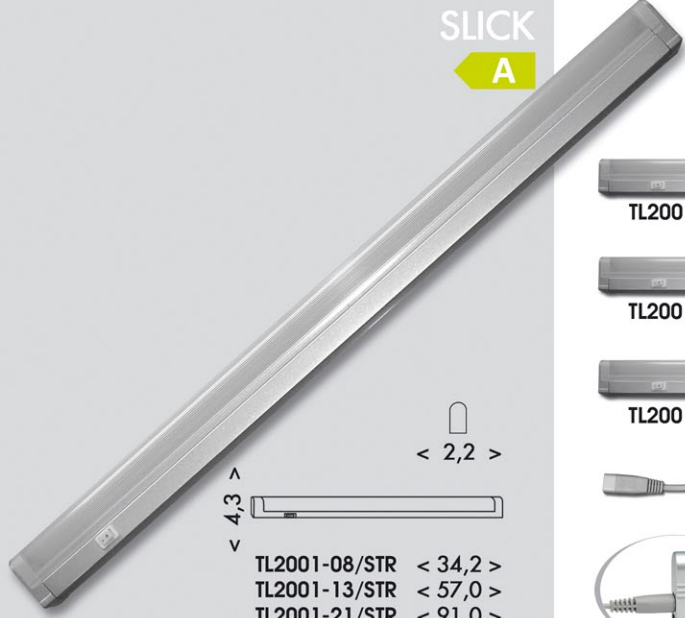

< 4,3 >
< 2,2 >
TL2001-08/STR < 34,2 >
TL2001-13/STR < 57,0 >
TL2001-21/STR < 91,0 >



TL2001-08/STR



TL2001-13/STR



TL2001-21/STR



TL2001-08/STR



TL2001-13/STR



TL2001-21/STR





LED / žárovková svítidla LED / žiarivkové svetidlá opravy oświetleniowe

GANYS

A

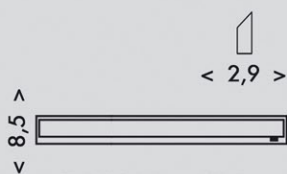

- TL2016-08 <math>< 35,5 ></math>
- TL2016-13 <math>< 58,4 ></math>
- TL2016-21 <math>< 91,7 ></math>



TL2016-08



TL2016-13



TL2016-21



TL2016-08



TL2016-13



TL2016-21



GANYS

A

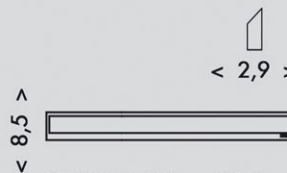

- TL2016-08/BI <math>< 35,5 ></math>
- TL2016-13/BI <math>< 58,4 ></math>
- TL2016-21/BI <math>< 91,7 ></math>

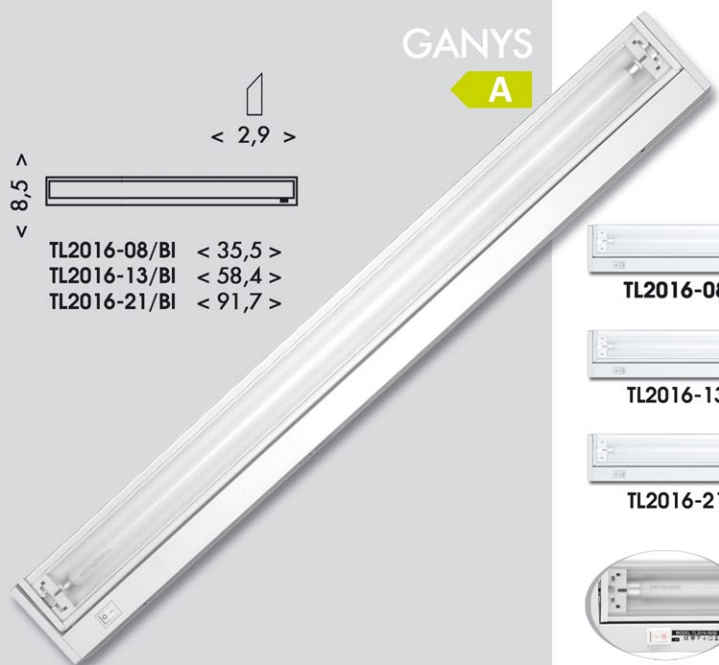

TL2016-08/BI



TL2016-13/BI



TL2016-21/BI



TL2016-08/BI



TL2016-13/BI



TL2016-21/BI





LED / zářivková svítidla LED / žiarivkové svietidlá opravy oświetleniowe

DINO

A



< 5,5 >

< 4,2 >

TL2003-08 < 31,0 >
TL2003-13 < 54,0 >



TL2003-08



TL2003-13



TL2003-08



TL2003-13



CAPRI

A



< 6,5 >

< 3,5 >

TL3011-10 < 41,3 >
TL3011-15 < 51,7 >
TL3011-18 < 67,1 >
TL3011-36 < 128,0 >



TL3011-10



TL3011-15



TL3011-18



TL3011-36



TL3011-10



TL3011-15



TL3011-18



TL3011-36



KORADO

A

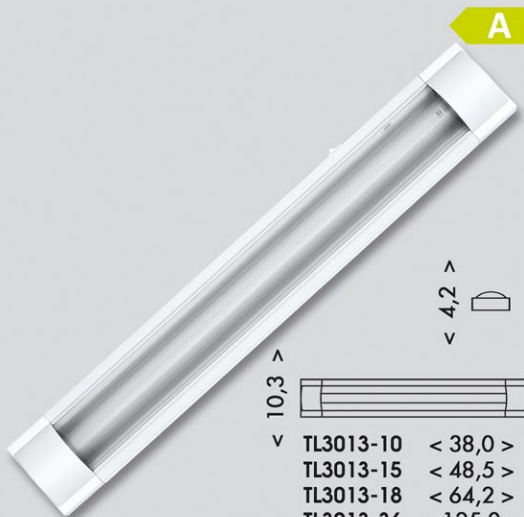

TL3013-10	< 38,0 >
TL3013-15	< 48,5 >
TL3013-18	< 64,2 >
TL3013-36	< 125,0 >



TL3013-10



TL3013-15



TL3013-18



TL3013-36



TL3013-10



TL3013-15



TL3013-18



TL3013-36



DERIK

A

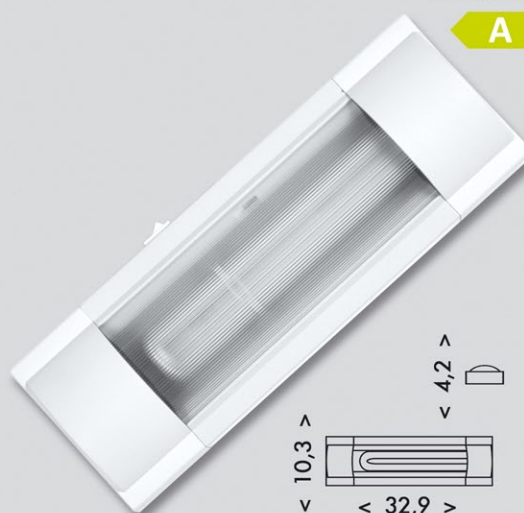

TL3014-11	< 32,9 >
-----------	----------



TL3014-11



TL3014-11



ROSA

A

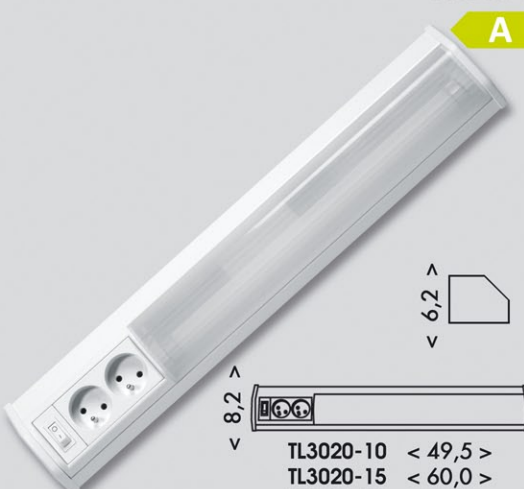

TL3020-10	< 49,5 >
TL3020-15	< 60,0 >
TL3020-18	< 75,5 >



TL3020-10



TL3020-15



TL3020-18



TL3020-10



TL3020-15



TL3020-18





Ecolite

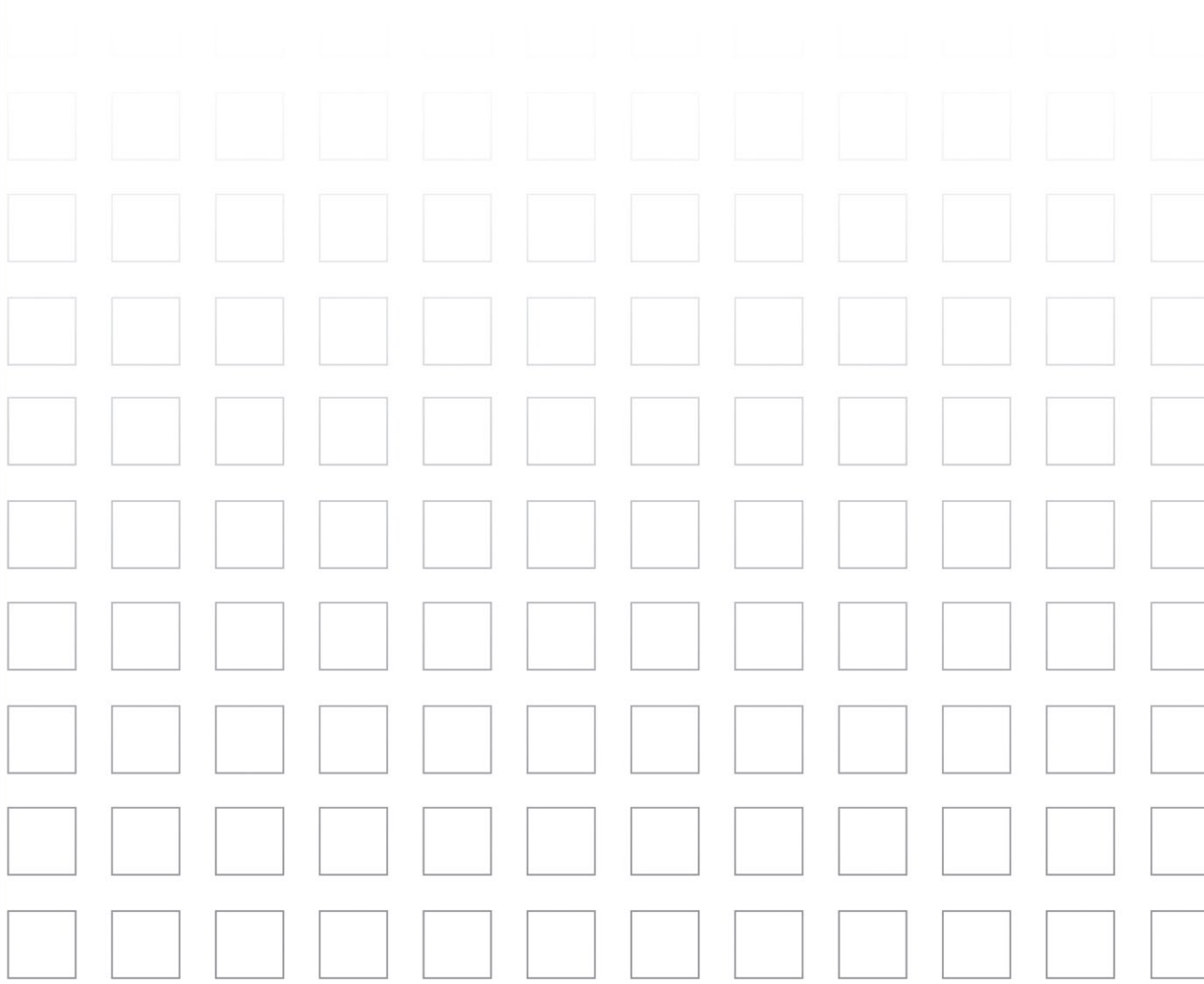

Ecolite



montážní lampy
montážne lampy
lampa montażowa

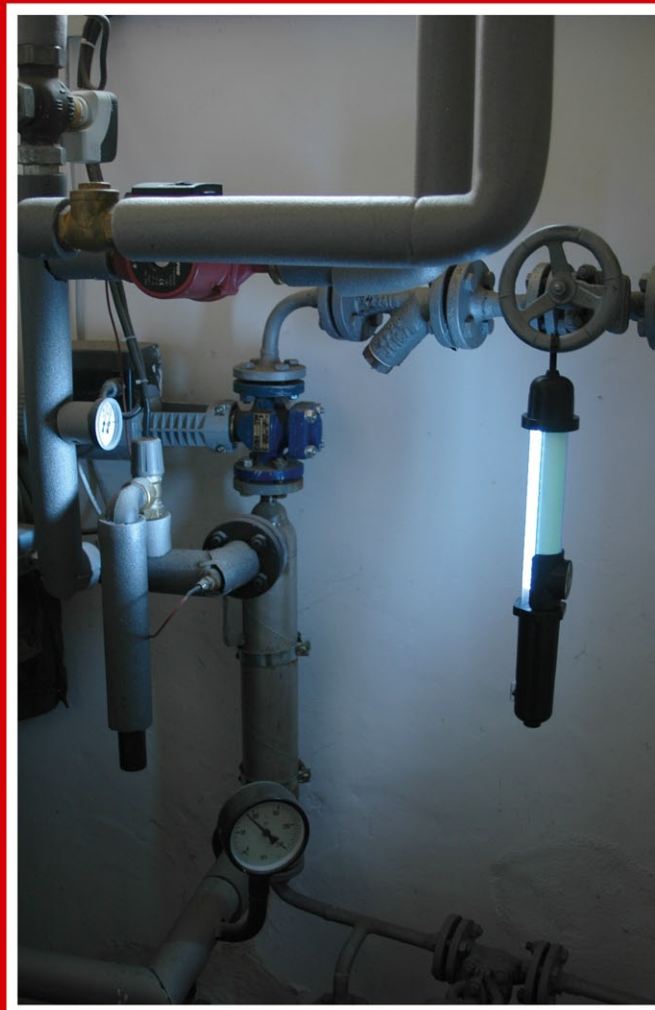



MONTER

A+



LED809-60/AKU



LED809-60/AKU



MECHANIC

A+



XD46B-3W/AKU



XD46B-3W/AKU



WORKER

A - D



TL2024-60



TL2024-60



Ecolite



technická svítidla
technické svietidlá
oprawy techniczne





ECOLITE

technická svítidla
technické svietidlá
opravy techniczne

NOVINKA
technology
LED

PILO SMD

A+

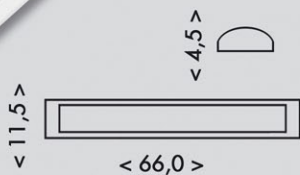

18W **1620lm**



TL220-LED18W



TL220-LED18W



NOVINKA
technology
LED

PILO SMD

A+

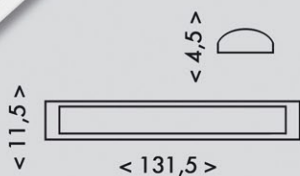
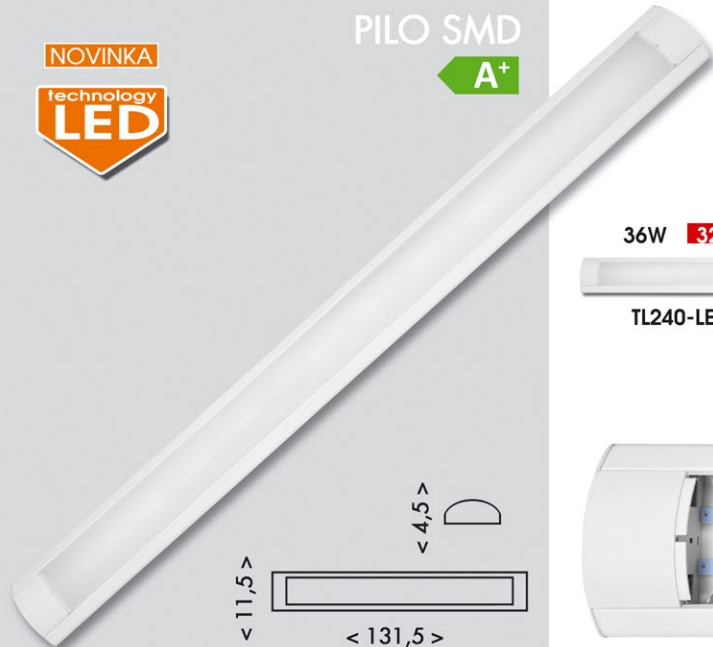

36W **3240lm**



TL240-LED36W



TL240-LED36W





ECOLITE

technická svítidla
technické svietidlá
opravy techniczne



PILO 2
A



TL220MP-2x18/EVG



TL220MP-2x18/EVG

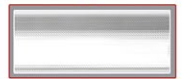

součástí balení

- CE
- ~230V
- F
- EVG
- Ø26
- T8
- G13
- max. 2x18W
- Grounding symbol
- IP20
- House icon
- A
- Grid icon
- Box icon with number 6



PILO 2
A



TL240MP-2x36/EVG

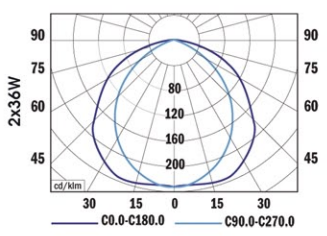
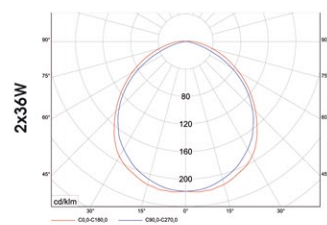

TL240MP-2x36/EVG

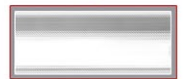

součástí balení

- CE
- ~230V
- F
- EVG
- Ø26
- T8
- G13
- max. 2x36W
- Grounding symbol
- IP20
- House icon
- A
- Grid icon
- Box icon with number 6



ECOLITE

technická svítidla
technické svietidlá
opravy techniczne

LIBRA SMD

A+

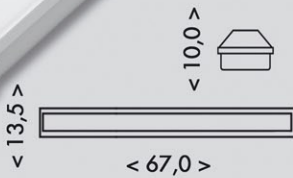

20W 1800lm



TL3901A-LED20W



TL3901A-LED20W



- CE
- ~230V
- F
- LED
- 140x SMD 2835
- max. 20W
- IP65
- 30000h
- 4100K
- Ra ≥80
- House icon
- ABS
- PS
- 4

LIBRA SMD

A+

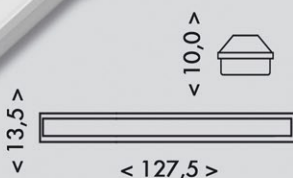

40W 3600lm



TL3902A-LED40W



TL3902A-LED40W



- CE
- ~230V
- F
- LED
- 280x SMD 2835
- max. 40W
- IP65
- 30000h
- 4100K
- Ra ≥80
- House icon
- ABS
- PS
- 4



ECOLITE

technická svítidla
technické svietidlá
opravy techniczne

OSIRIS

A

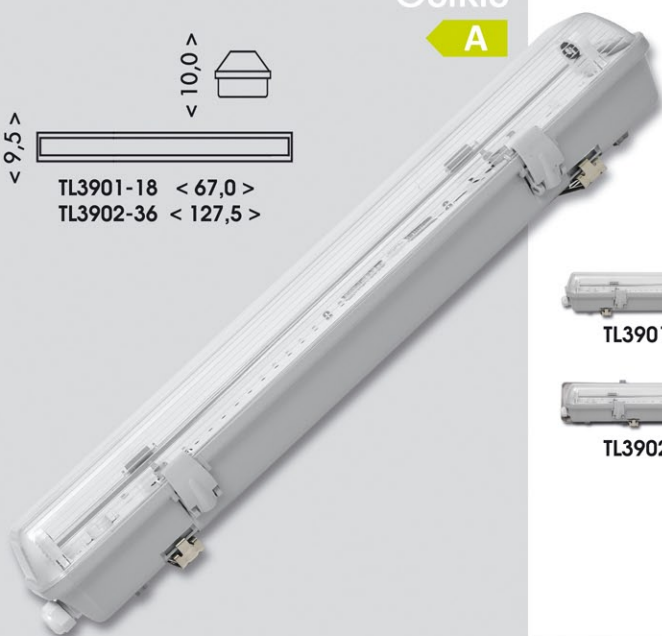
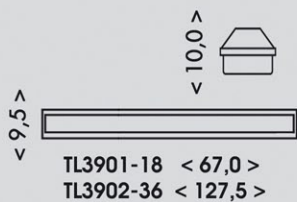

TL3901-18



TL3902-36



TL3901-18



TL3902-36



36W

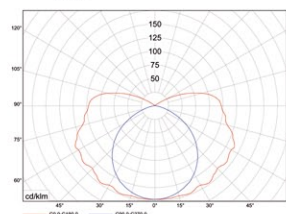

LIBRA

A

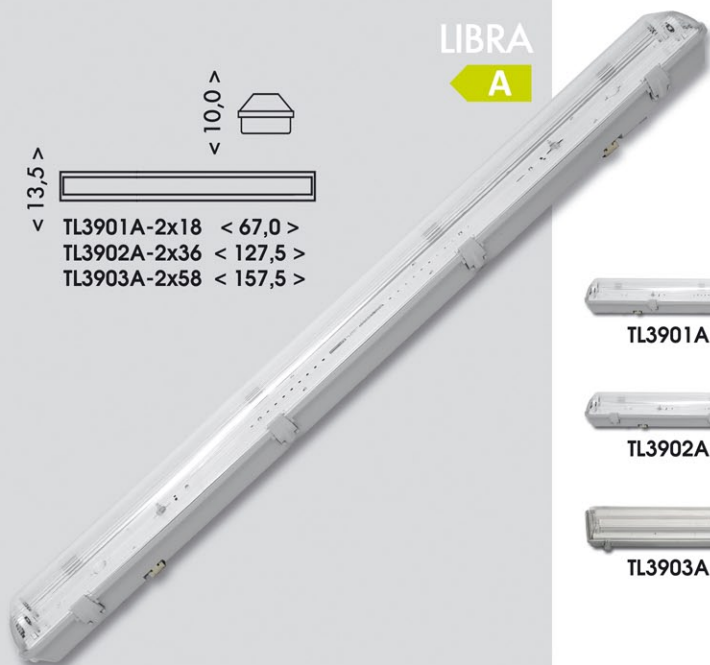
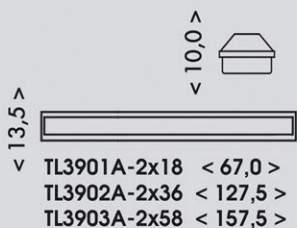

TL3901A-2x18



TL3902A-2x36



TL3903A-2x58

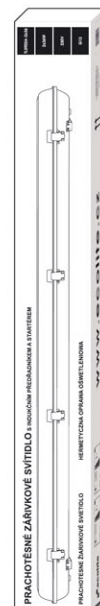

TL3901A-2x18



TL3902A-2x36



TL3903A-2x58



2x36W

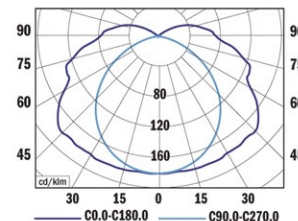



technická svítidla
technické svietidlá
opravy techniczne

NOVINKA

LIBRA 2

A



TL3902A-2x36/EVG

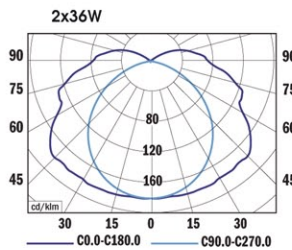

TL3902A-2x36/EVG

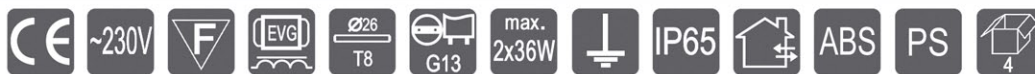
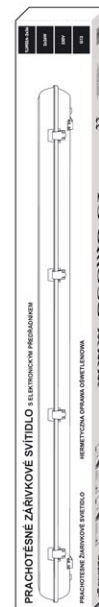

NOVINKA

LIBRA 2

A+



TL3902A-2x36/B

INSTALUJTE
LEDTUBE-120/20W



TL3902A-2x36/B

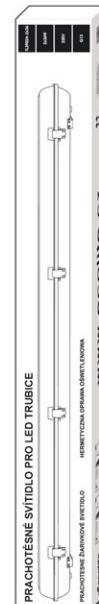



technická svítidla technické svietidlá opravy techniczne

NOVINKA
technology
LED

LEDER
A+

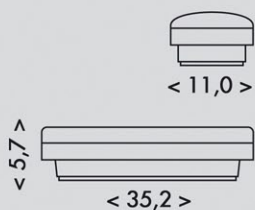

TL638L-LED



TL638L-LED



8 590849 520019

- CE
- ~230V
- F
- NiCD ACCU
- 3.6V 1.5Ah
- LED
- 10x SMD 5730
- max. 3,3W
- * max. 3h
- IP65
- 30000h
- 5000K
- Ra ≥ 80
- House icon
- Grid icon
- Box icon 10

EXIT
A

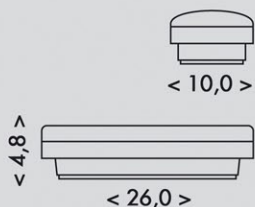

TL106-06



TL106-06



8 590849 502862

- CE
- ~230V
- F
- NiCD ACCU
- 2.4V 1.8Ah
- T5
- G5
- max. 6W
- * max. 1,5h
- IP20
- Ra ≥ 80
- House icon
- Grid icon
- Box icon 20



ECOLITE

technická svítidla
technické svietidlá
opravy techniczne

EXIT 2



TL248-1x8



TL248-1x8

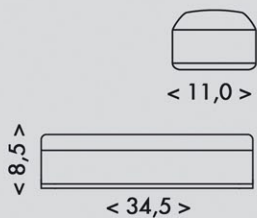

EXIT 3



TL248-2x8



TL248-2x8

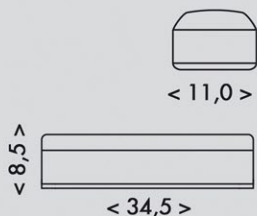



ECOlight

technická svítidla
technické svietidlá
opravy techniczne

NOUZAK 16

A

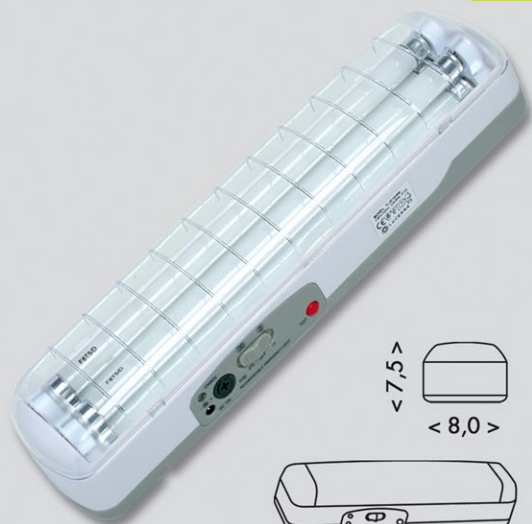

< 7,5 >
< 8,0 >

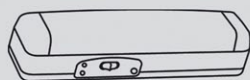

< 34,5 >



TL238-2x8



TL238-2x8



8 590849 238006



LEDIS

A+



< 4,5 >
< 6,5 >

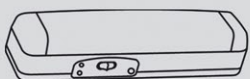

< 23,0 >



1,2W 120lm

TL5205-30LED



TL5205-30LED



8 590849 502855





ecolite

technická svítidla
technické svietidlá
opravy techniczne

NEPTUN 2

A - D

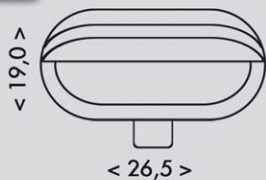

WHST69-BI



WHST69-CR



WHST69-BI



WHST69-CR

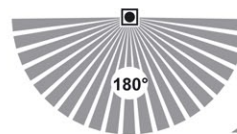

NEPTUN

A - D

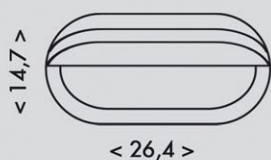

WH2606-BI



WH2606-CR



WH2606-BI



WH2606-CR



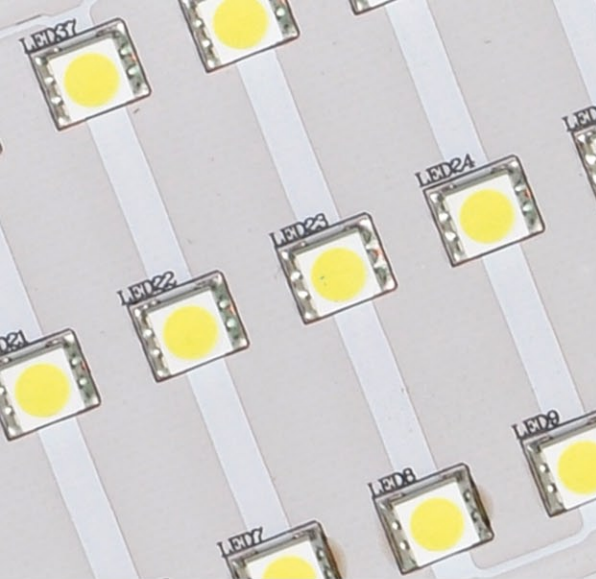

ECOLITE

technická svítidla
technické svietidlá
opravy techniczne

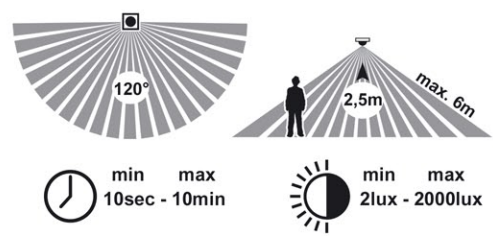
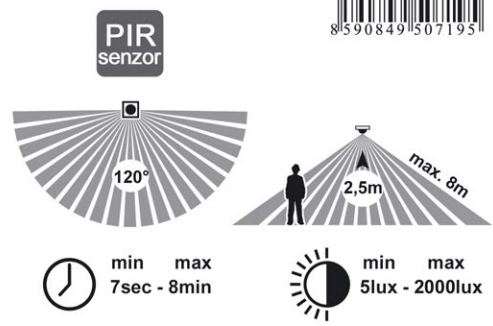

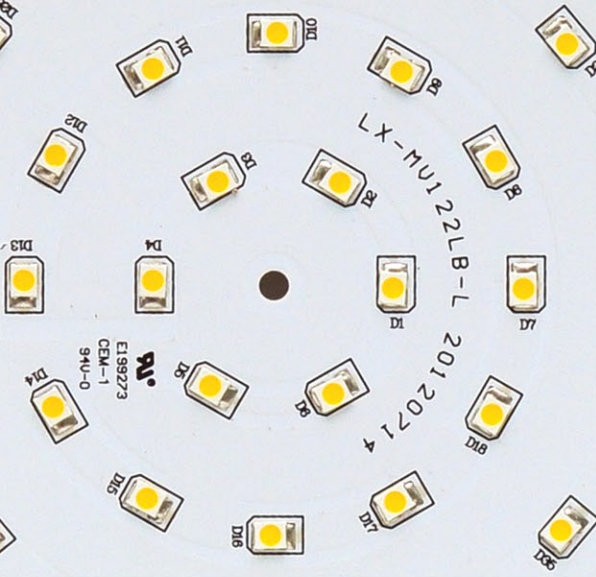

ECOLITE

technická svítidla
technické svietidlá
opravy techniczne

VICTOR LED

A+



8,0

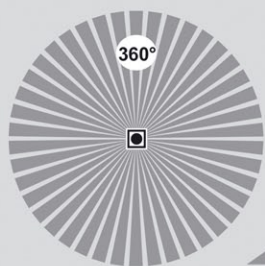
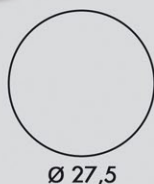

HF senzor detekuje pohyb i přes sklo a lehké stavební materiály.

min max
8sec - 12min

min max
2lux - 2000lux

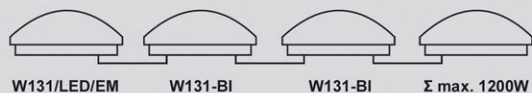

780lm



W131/LED/EM-3000

830lm



W131/LED/EM-4100



W131/LED/EM-3000



W131/LED/EM-4100





VICTOR LED

A+



< 10,0 >

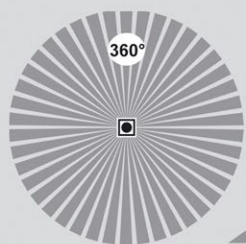
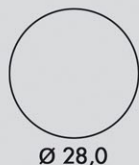

min 8sec - 12min

min 2lux - 2000lux

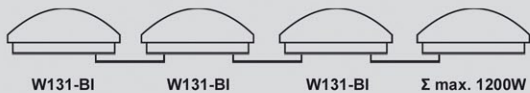

W131-BI W131-BI W131-BI Σ max. 1200W

970lm



W131/LED-3000

970lm



W131/LED-4100



W131/LED-3000



W131/LED-4100



VICTOR LED B



A+



< 10,0 >

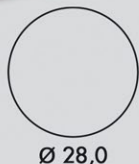

970lm



W131/LED/B-3000

970lm



W131/LED/B-4100



W131/LED/B-3000



W131/LED/B-4100





ECOLITE

technická svítidla
technické svietidlá
opravy techniczne

VICTOR

A - D



> 8,0 <

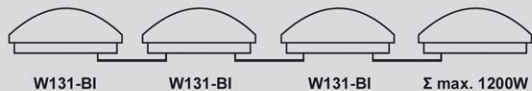
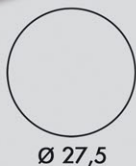

W131-BI W131-BI W131-BI Σ max. 1200W



W131-BI



W131-BI

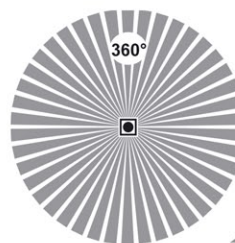

min max
8sec - 12min

min max
2lux - 2000lux



VICTOR B

A - D



> 8,0 <

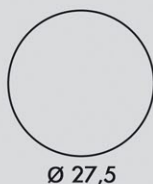

W131/B-BI



W131/B-BI



NOVINKA

VICTOR

A - D



< 12,0 >

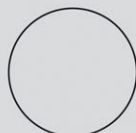

Ø 37,0

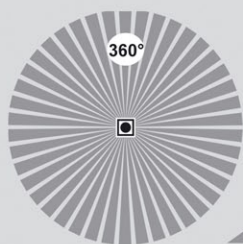

min max
8sec - 12min

min max
2lux - 2000lux



W141-BI

W141-BI

W141-BI

Σ max. 1200W



W141-BI



W141-BI



8 5 9 0 8 4 9 1 5 1 8 1 0 8



NOVINKA

VICTOR B

A - D



< 12,0 >

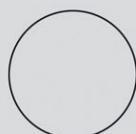

Ø 37,0



W141/B-BI



W141/B-BI



8 5 9 0 8 4 9 1 5 1 8 0 9 2



NOVINKA
technology
LED

VICTOR LED

A+



< 12,0 >

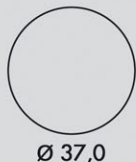

Ø 37,0

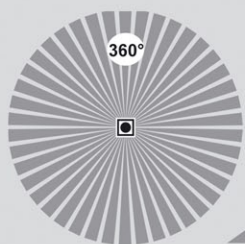

min max
8sec - 12min

min max
2lux - 2000lux



W131-BI

W131-BI

W131-BI

Σ max. 1200W

1600lm



W141/LED-3000

1600lm



W141/LED-4100



W141/LED-3000



W141/LED-4100



VICTOR LED B

NOVINKA
technology
LED

A+



< 12,0 >

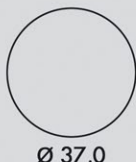

Ø 37,0

1600lm



W141/LED/B-3000

1600lm



W141/LED/B-4100



W141/LED/B-3000



W141/LED/B-4100





ECOLITE

technická svítidla
technické svietidlá
opravy techniczne

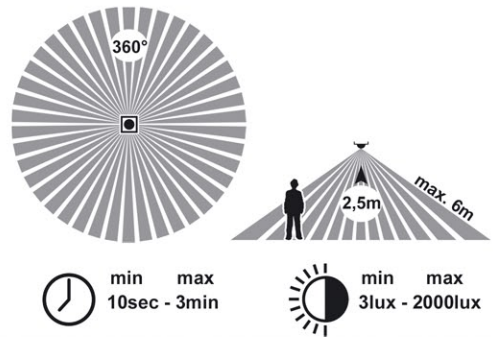

- CE
- ~230V
- F
- Light bulb icon
- 2xE27
- max. 2x40W
- Grounding symbol
- IP20
- House icon
- 360°
- 6m
- Installation icon
- Light fixture icon
- 5

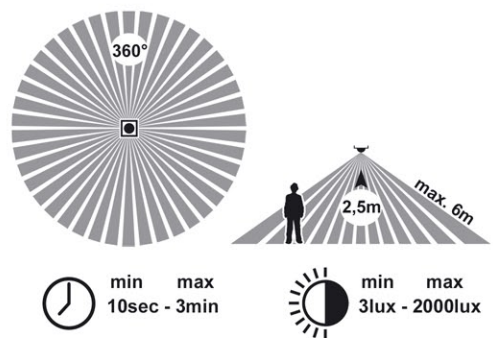

- CE
- ~230V
- F
- LED
- 24x SMD 2835
- max. 14W
- Grounding symbol
- IP20
- 30000h
- 3000K
- 4100K
- Ra ≥80
- House icon
- 360°
- 6m
- Light fixture icon
- 10

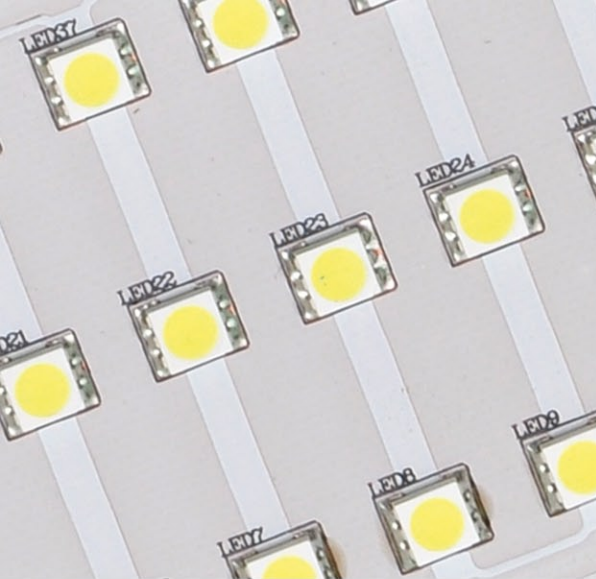

technická svítidla technické svietidlá opravy techniczne

NOVINKA



BELA



11W - 27,0x27,0
22W - 37,0x37,0

11W **1100lm**



WD002-11W/LED

22W **2100lm**



WD002-22W/LED



WD002-11W/LED



8 590 849 515 473

WD002-22W/LED



8 590 849 515 503



-
-
-
-
-
-
-
-
-
-
-
-
-
-
-
-
-
-





ANETA

A+

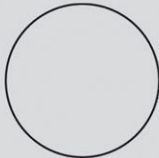

WS005-12W/LED Ø 29,0
WS005-16W/LED Ø 36,0
WS005-22W/LED Ø 40,0



WS005-12W/LED 9,0
WS005-16W/LED 9,5
WS005-22W/LED 10,0

900lm



WS005-12W/LED

1260lm



WS005-16W/LED

1740lm



WS005-22W/LED



WS005-12W/LED



WS005-16W/LED



WS005-22W/LED



ELIS

A+



WY002-11W/LED 28,0x28,0
WY002-22W/LED 38,0x38,0



WY002-11W/LED 9,0
WY002-22W/LED 10,0

880lm



WY002-11W/LED

1740lm



WY002-22W/LED



WY002-11W/LED



WY002-22W/LED





ECOLITE

technická svítidla
technické svietidlá
oprawy techniczne

CIRCO

A

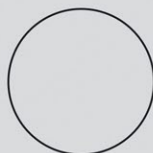

WSE22-BI Ø 28,5
WSE32-BI Ø 30,5
WSE40-BI Ø 40,5

10,0
v



WSE22-BI



WSE32-BI



WSE40-BI



WSE22-BI



WSE32-BI



WSE40-BI



reflektory
reflektory
lampy reflektorowe

ecolite



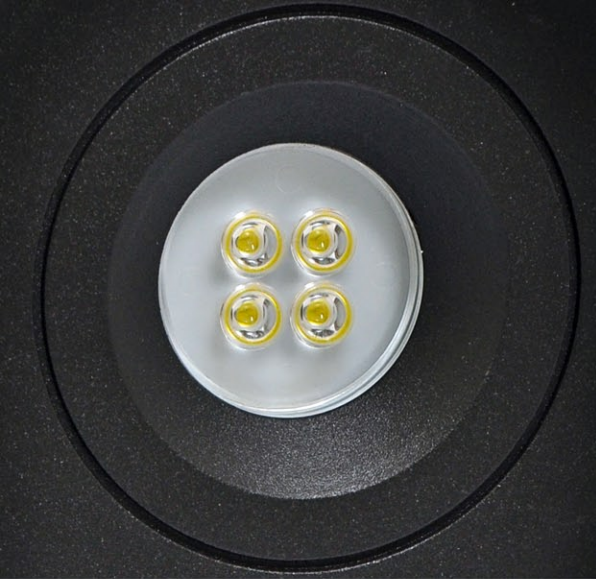

reflektory reflektory lamps reflektorowe

NOVINKA

UFO

A+



technology
LED

< 9,0 >

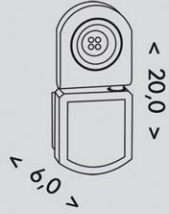

10W 720lm



RL3226-10W



RL3226-10W

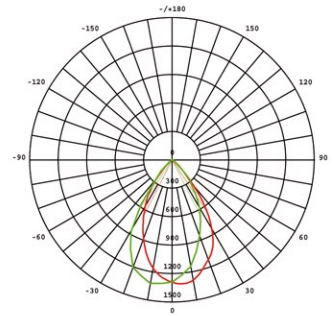

- CE
- ~230V
- F
- LED
- 4x SMD 3535
- max. 10W
- 150°
- IP54
- 30000h
- 6400K
- Ra ≥80
- House icon
- A
- Light distribution icon
- 12

NOVINKA

technology
LED

UFO

A+



< 20,0 >

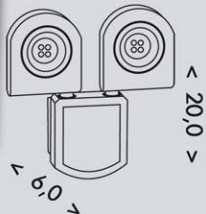

20W 1440lm



RL3226-2x10W



RL3226-2x10W

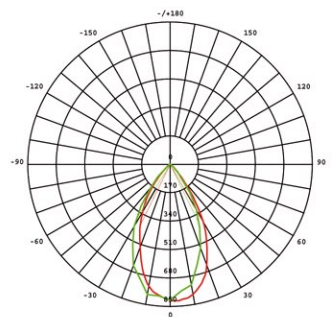

- CE
- ~230V
- F
- LED
- 8x SMD 3535
- max. 20W
- 150°
- IP54
- 30000h
- 6400K
- Ra ≥80
- House icon
- A
- Light distribution icon
- 8



reflektory reflektory lamps reflektorowe

NOVINKA

UFO

A+



technology
LED

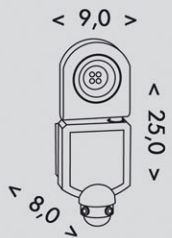

10W 720lm

Ra
≥80



RL3226S-10W



RL3226S-10W

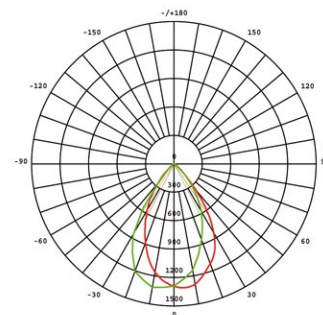

- CE
- ~230V
- F
- LED
- 4x SMD 3535
- max. 10W
- 150°
- PIR senzor
- 140°
- 12m
- IP54
- 30000h
- 6400K
- House icon
- AI
- Light fixture icon
- 12

NOVINKA

technology
LED

UFO

A+

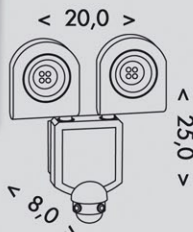

20W 1440lm

Ra
≥80



RL3226S-2x10W



RL3226S-2x10W

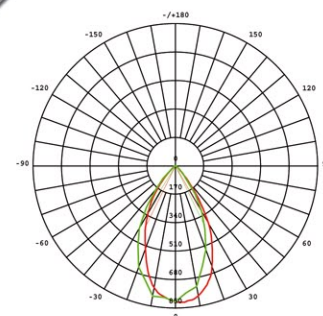

- CE
- ~230V
- F
- LED
- 8x SMD 3535
- max. 20W
- 150°
- PIR senzor
- 140°
- 12m
- IP54
- 30000h
- 6400K
- House icon
- AI
- Light fixture icon
- 8



reflektory reflektory lampy reflektorowe

NOVINKA

SLIM
A+



technology
LED

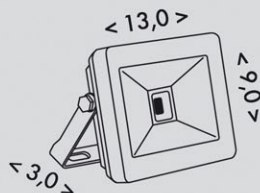

800lm



RLHJ10W-BI/4100

800lm



RLHJ10W-CR/4100



RLHJ10W-BI/4100



RLHJ10W-CR/4100

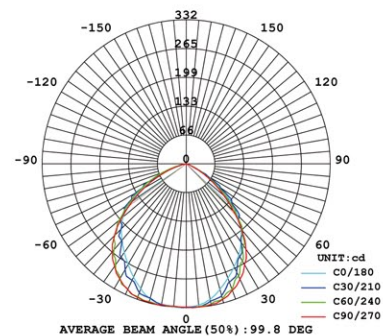

NOVINKA

SLIM
A+



technology
LED

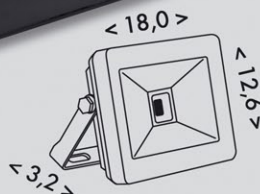

1600lm



RLHJ20W-BI/4100

1600lm



RLHJ20W-CR/4100



RLHJ20W-BI/4100



RLHJ20W-CR/4100

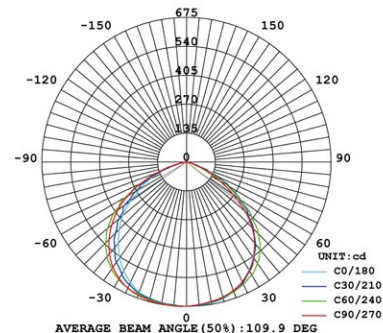



reflektory reflektory lampy reflektorowe

NOVINKA

SLIM
A+



technology
LED



2400lm



RLHJ30W-BI/4100

2400lm



RLHJ30W-CR/4100



RLHJ30W-BI/4100



RLHJ30W-CR/4100

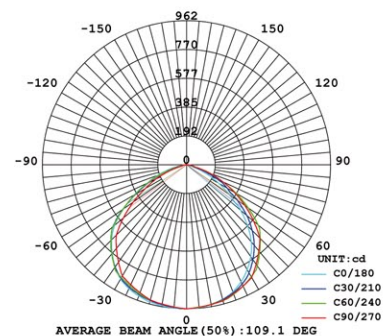

NOVINKA

SLIM
A+



technology
LED

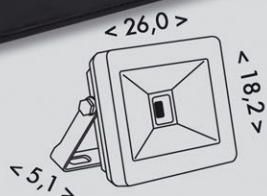

4000lm



RLHJ50W-BI/4100

4000lm



RLHJ50W-CR/4100



RLHJ50W-BI/4100



RLHJ50W-CR/4100

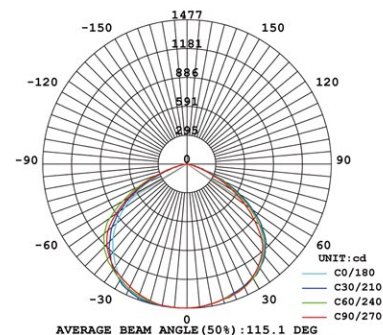

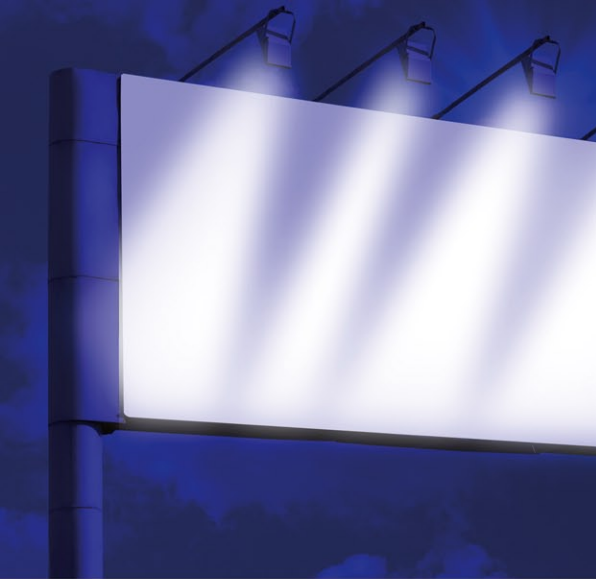

reflektory reflektory lampy reflektorowe

NOVINKA

SLIM
A+



technology
LED

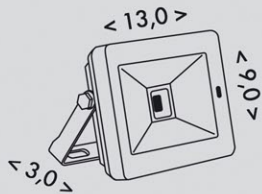

800lm

Ra
 ≥ 80



RLHJ10W-BI/HF/4100



RLHJ10W-BI/HF/4100



RLHJ10W-CR/HF/4100



800lm

Ra
 ≥ 80



RLHJ10W-CR/HF/4100

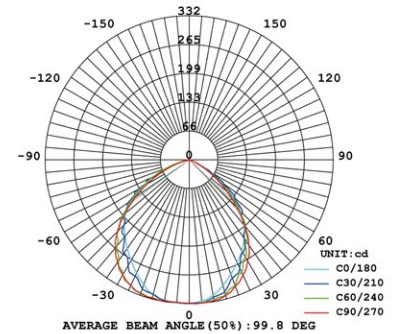

NOVINKA

SLIM
A+



technology
LED

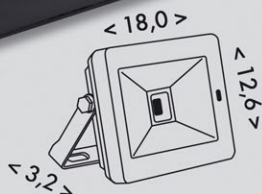

1600lm

Ra
 ≥ 80



RLHJ20W-BI/HF/4100



RLHJ20W-BI/HF/4100



RLHJ20W-CR/HF/4100



1600lm

Ra
 ≥ 80



RLHJ20W-CR/HF/4100

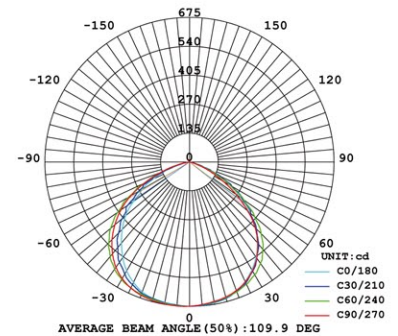



REFLEKTORY

reflektory
reflektory
lampy reflektorowe

NOVINKA

SLIM

A+



technology
LED

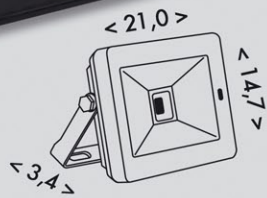

2400lm

Ra
 ≥ 80



RLHJ30W-BI/HF/4100



RLHJ30W-BI/HF/4100



RLHJ30W-CR/HF/4100



2400lm

Ra
 ≥ 80



RLHJ30W-CR/HF/4100

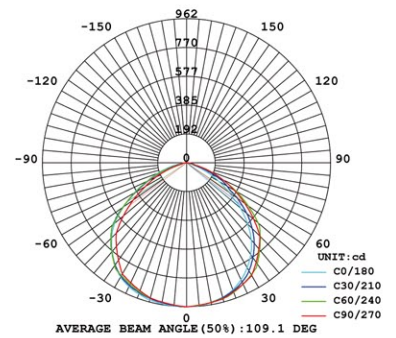

- CE
- ~230V
- F
- LED
- 1x COB LED
- max. 30W
- 140°
- HF senzor
- 160°
- 8m
- IP65
- 30000h
- 4100K
- AI
- 10

NOVINKA

SLIM

A+



technology
LED

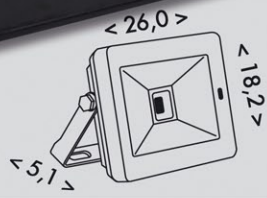

4000lm

Ra
 ≥ 80



RLHJ50W-BI/HF/4100



RLHJ50W-BI/HF/4100



RLHJ50W-CR/HF/4100



4000lm

Ra
 ≥ 80



RLHJ50W-CR/HF/4100

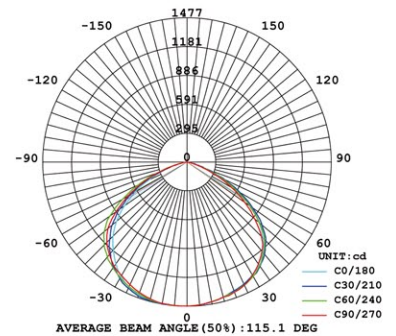

- CE
- ~230V
- F
- LED
- 1x COB LED
- max. 50W
- 140°
- HF senzor
- 160°
- 8m
- IP65
- 30000h
- 4100K
- AI
- 10

GARY

A+

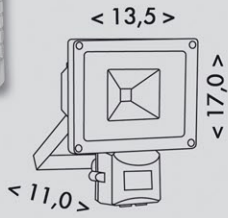
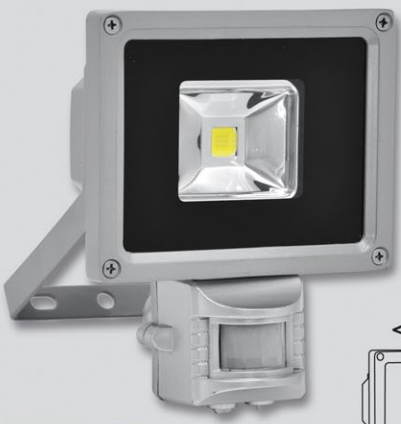

RLED F01-10W/PIR/3500



RLED F01-10W/PIR/5000



RLED F01-10W/PIR/3500



8 590849 510577

RLED F01-10W/PIR/5000



8 590849 508024

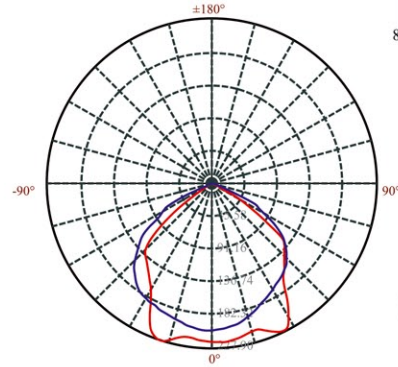

GARY

A+

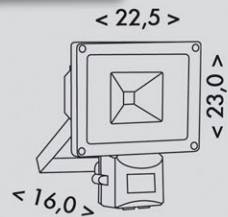

RLED F02-30W/PIR/3500



RLED F02-30W/PIR/5000



RLED F02-30W/PIR/3500



8 590849 510584

RLED F02-30W/PIR/5000



8 590849 508062

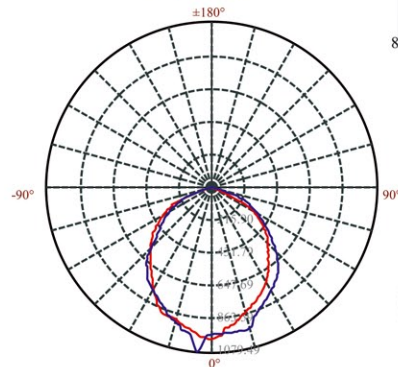

GARY

A+



NOVINKA

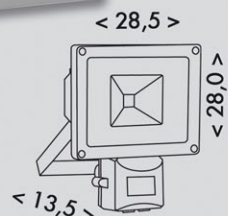

RLED F03-50W/PIR/3500



RLED F03-50W/PIR/5000



RLED F03-50W/PIR/3500



8 590849 513509

RLED F03-50W/PIR/5000



8 590849 513516





reflektory reflektory lamps reflektorowe

GARY

A+

technology
LED



820lm



RLEDF01-10W/STJ



RLEDF01-10W/STJ



8 590849 508048

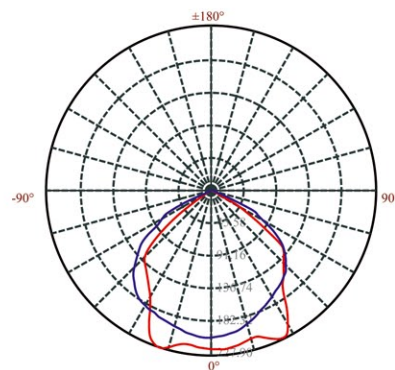

GARY

A+

technology
LED



2520lm



RLEDF02-30W/STJ



RLEDF02-30W/STJ



8 590849 508086

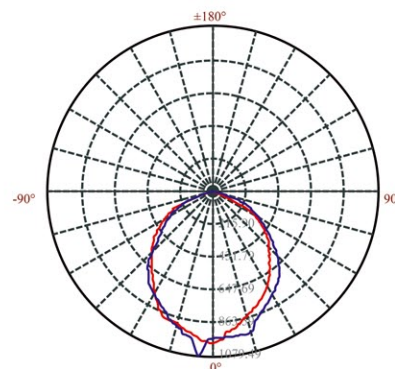



REFLECTOR SMD

A+

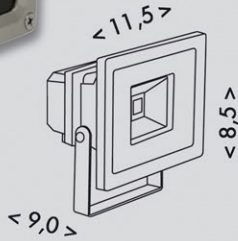

800lm



RLEDF01-10W/3500

820lm



RLEDF01-10W/5000



RLEDF01-10W/3500



RLEDF01-10W/5000

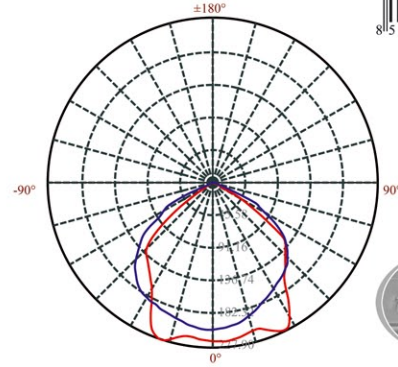

REFLECTOR SMD

A+

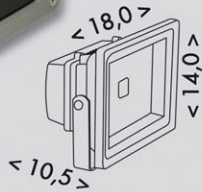

1640lm



RLEDF02-20W/3500

1660lm



RLEDF02-20W/5000



RLEDF02-20W/3500



RLEDF02-20W/5000

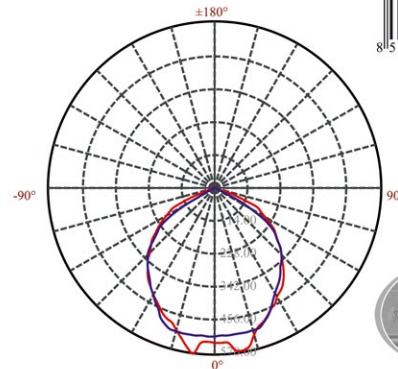

REFLECTOR SMD

A+

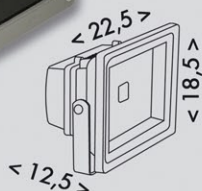

2460lm



RLEDF02-30W/3500

2520lm



RLEDF02-30W/5000



RLEDF02-30W/3500



RLEDF02-30W/5000

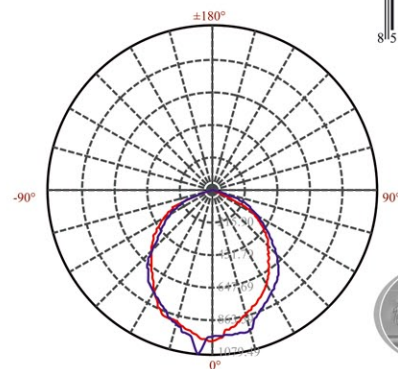



reflektory reflektory lampy reflektorowe

REFLECTOR SMD



A+

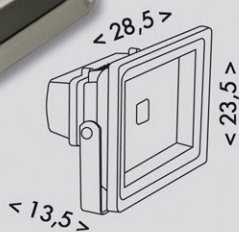

4100lm



RLEDF03-50W/3500

4200lm



RLEDF03-50W/5000



RLEDF03-50W/3500



RLEDF03-50W/5000



REFLECTOR SMD

A+

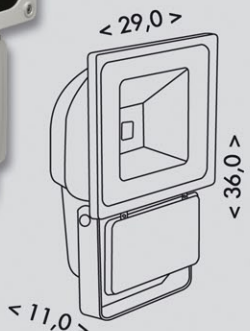

8200lm



RLEDF04-100W/3500

8400lm



RLEDF04-100W/5000



RLEDF04-100W/3500



RLEDF04-100W/5000



REFLECTOR F500

D



R6501-CR



R6501-CR



8 590849 502459



REFLECTOR F2x500

D

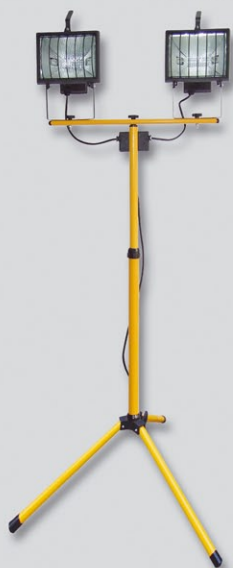

R6502-CR



R6502-CR



8 590849 502480



STOJAN

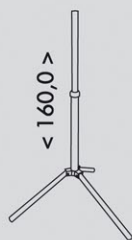

R-STOJAN



R-STOJAN



8 590849 503838



REFLECTOR 150

D



< 18,5 >

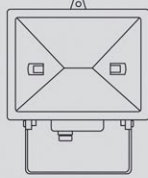

< 13,5 >



< 9,0 >



R6105-BI



R6105-CR



R6105-BI



R6105-CR



REFLECTOR 500

D



< 25,5 >

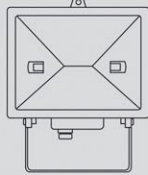

< 18,0 >



< 13,5 >



R6107-BI



R6107-CR



R6107-BI



REFLECTOR 1000

D



< 29,5 >

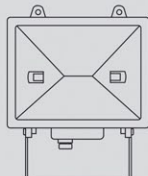

< 27,0 >



< 12,0 >



R6109-CR



R6109-CR





reflektory
reflektory
lampy reflektorowe

REFLECTOR II 150

D



< 12,0 >

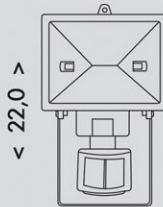

> 22,0 <

< 13,5 >



R6304-BI



R6304-CR



R6304-BI



R6304-CR



REFLECTOR II 500

D

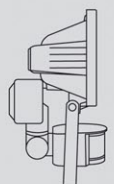

< 13,0 >

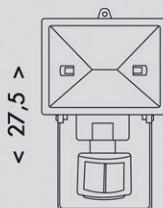

> 27,5 <

< 18,0 >



R6405-BI



R6405-CR



R6405-BI



R6405-CR





reflektory reflektory lamps reflektorowe

REFLECTOR III 150

D

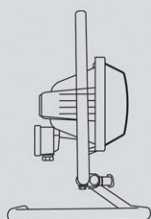

< 16,5 >

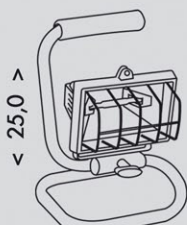

< 25,0 >

< 18,0 >



R6403-CR



R6403-CR



8 590849 064032



REFLECTOR III 500

D

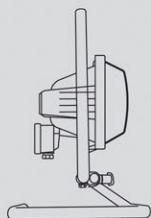

< 20,0 >

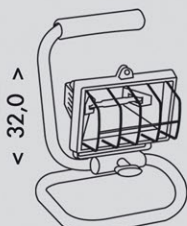

< 32,0 >

< 23,5 >



R6404-CR



R6404-CR



8 590849 064049





reflektory reflektory lampy reflektorowe

ORAVA 2

A

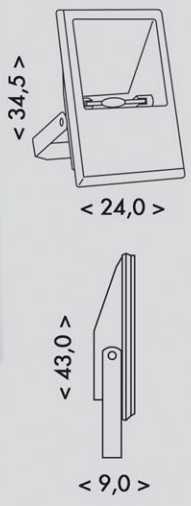

R3006-70



R3006-150



R3006-70



R3006-150

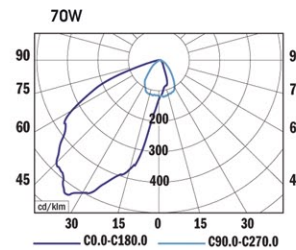

CRONO 3

A

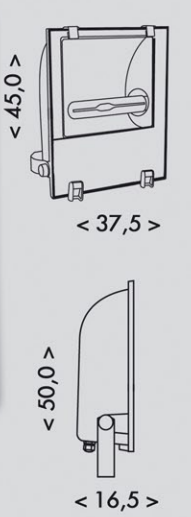

R3007-250



R3007-400



R3007-250



R3007-400

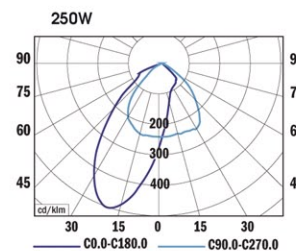

■ ■ Ecolite

světelné zdroje
svetelné zdroje
źródła światła



MINI SPIRAL

A



Ø3,2

E14/9W < 9,5 >



ECOSPIRAL14/9

E14/11W < 10,5 >



ECOSPIRAL14/11

E27/9W < 9,0 >



ECOSPIRAL27/9

E27/11W < 10,0 >



ECOSPIRAL27/11



ECOSPIRAL14/9



ECOSPIRAL14/11



ECOSPIRAL27/9



ECOSPIRAL27/11



MINI SPIRAL 2700

A



Ø3,2

E14/11W < 10,5 >



ECOSPIRAL14/11/27

E27/9W < 9,0 >



ECOSPIRAL27/27

E27/11W < 10,0 >



ECOSPIRAL27/11/27



ECOSPIRAL14/11/27



ECOSPIRAL27/9/27



ECOSPIRAL27/11/27



SPIRAL

A

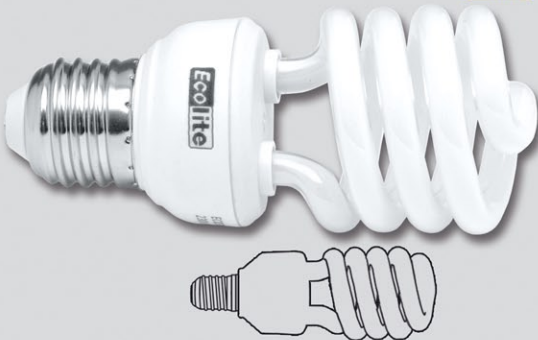

E27/15W - Ø4,5
E27/20W - Ø5,5
E27/26W - Ø5,5
E27/46W - Ø7,8
E40/105W - Ø10,0

E27/15W < 10,5 >



ECOSPIRAL27/15

E27/20W < 10,5 >



ECOSPIRAL27/20

E27/26W < 11,5 >



ECOSPIRAL27/26

E27/46W < 21,0 >



ECOSPIRAL27/46

E40/105W < 29,0 >



ECOSPIRAL40/105



ECOSPIRAL27/15



ECOSPIRAL27/20



ECOSPIRAL27/26



ECOSPIRAL27/46



ECOSPIRAL40/105





ECOLITE

světelné zdroje
svetelné zdroje
źródła światła

SPIRAL 2700

A



E27/15W - Ø4,5
E27/20W - Ø5,5
E27/26W - Ø5,5

E27/15W < 10,5 >



ECOSPIRAL27/15/27

E27/20W < 10,5 >



ECOSPIRAL27/20/27

E27/26W < 11,5 >



ECOSPIRAL27/26/27



ECOSPIRAL27/15/27



8 59 08 49 15 12 07 6

ECOSPIRAL27/20/27



8 59 08 49 15 12 08 3

ECOSPIRAL27/26/27



8 59 08 49 15 12 09 0



EUROLITE

A

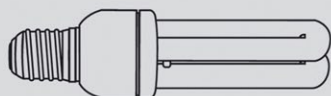

Ø4,2
20W, 23W - Ø4,8

E14/11W-2U < 13,4 >



EUROLITE14/11

E27/9W-2U < 14,5 >



EUROLITE27/9

E27/11W-2U < 14,5 >



EUROLITE27/11

E27/15W-2U < 15,8 >



EUROLITE27/15

E27/20W-3U < 15,3 >



EUROLITE27/20

E27/23W-3U < 16,5 >



EUROLITE27/23

EUROLITE14/11



8 59 13 74 11 41 11 7

EUROLITE27/9



8 59 13 74 12 70 9 4

EUROLITE27/11



8 59 13 74 12 71 1 7

EUROLITE27/15



8 59 13 74 12 71 5 5

EUROLITE27/20



8 59 13 74 12 72 0 9

EUROLITE27/23



8 59 13 74 12 72 3 0





světelné zdroje svetelné zdroje źródła światła

SMD E27

A⁺

NOVINKA

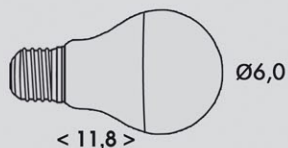

400lm



LED5W-A60/E27/3000

420lm



LED5W-A60/E27/4200



LED5W-A60/E27/3000



LED5W-A60/E27/4200



SMD E27

A⁺

NOVINKA

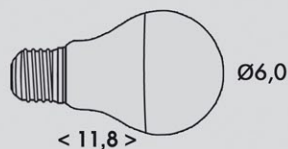

640lm



LED8W-A60/E27/3000

660lm



LED8W-A60/E27/4200



LED8W-A60/E27/3000



LED8W-A60/E27/4200



SMD E27

A⁺

NOVINKA



< 11,5 >



730lm



LED10W-A60/E27/3000

750lm



LED10W-A60/E27/4200



LED10W-A60/E27/3000



8 590849 514940

LED10W-A60/E27/4200



8 590849 514964



~230V



20x SMD 5630

max. 10W



40000h

3000K

4200K

Ra ≥80



SMD E27

A⁺

NOVINKA



< 11,5 >



930lm



LED12W-A60/E27/3000

950lm



LED12W-A60/E27/4200



LED12W-A60/E27/3000



8 590849 515015

LED12W-A60/E27/4200



8 590849 515046



~230V



24x SMD 5630

max. 12W



40000h

3000K

4200K

Ra ≥80



SMD E27

A⁺

NOVINKA



< 11,7 >



1200lm



LED15W-A60/E27/2700

1270lm



LED15W-A60/E27/4100



LED15W-A60/E27/2700



8 590849 519211

LED15W-A60/E27/4100



8 590849 519228



~230V



30x SMD 5730

max. 15W



30000h

2700K

4100K

Ra ≥80



NOVINKA

SMD G45

A+



430lm



LED5W-G45/E14/2700

450lm



LED5W-G45/E14/4100



LED5W-G45/E14/2700



LED5W-G45/E14/4100



NOVINKA

SMD G45

A+

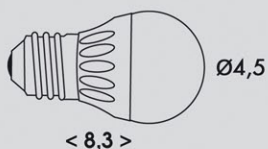

430lm



LED5W-G45/E27/2700

450lm



LED5W-G45/E27/4100



LED5W-G45/E27/2700



LED5W-G45/E27/4100



NOVINKA

SMD GLOBE

A+

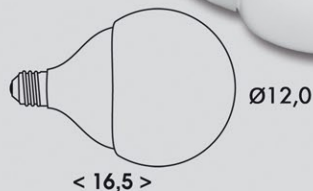

1730lm



LED20W-G120/E27/27

1790lm



LED20W-G120/E27/41



LED20W-G120/E27/27



LED20W-G120/E27/41





světelné zdroje svetelné zdroje źródła światła

NOVINKA

SMD C37

A⁺

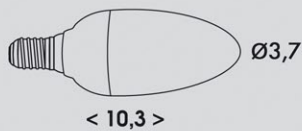

430lm



LED5W-SV/E14/2700

450lm



LED5W-SV/E14/4100



LED5W-SV/E14/2700



LED5W-SV/E14/4100



NOVINKA

SMD R50

A⁺

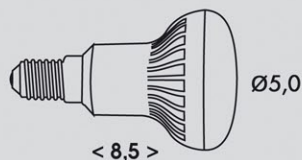

480lm



LED6,5W-E14/R50/3000

510lm



LED6,5W-E14/R50/4200



LED6,5W-E14/R50/3000



LED6,5W-E14/R50/4200



SMD 40

A+

NOVINKA

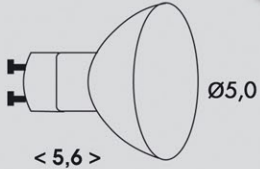

430lm



LED40SMD-GU10/2700

450lm



LED40SMD-GU10/4100



LED40SMD-GU10/2700



LED40SMD-GU10/4100



SMD 40

A+

NOVINKA

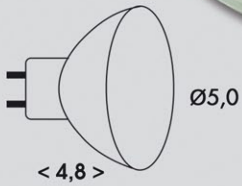

430lm



LED40SMD-MR16/2700

450lm



LED40SMD-MR16/4100



LED40SMD-MR16/2700



LED40SMD-MR16/4100



SMD 40

A+

NOVINKA

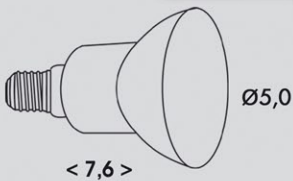

430lm



LED40SMD-JDR/2700

450lm



LED40SMD-JDR/4100



LED40SMD-JDR/2700



LED40SMD-JDR/4100





světelné zdroje svetelné zdroje źródła światła

SMD GU10

A+

NOVINKA

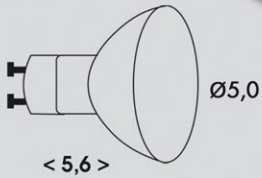

370lm



LED5W-GU10/2700

400lm



LED5W-GU10/4100



LED5W-GU10/2700



LED5W-GU10/4100



- CE
- ~230V
- LED
- GU10
- 12x SMD 2835
- max. 5W
- 120°
- 50000h
- 2700K
- 4100K
- Ra ≥80
- 100
- 10

SMD GU10

A+

NOVINKA

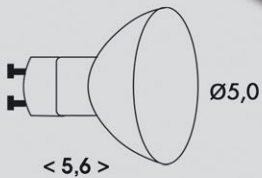

530lm



LED7,5W-GU10/2700

560lm



LED7,5W-GU10/4100



LED7,5W-GU10/2700



LED7,5W-GU10/4100



- CE
- ~230V
- LED
- GU10
- 18x SMD 2835
- max. 7,5W
- 120°
- 50000h
- 2700K
- 4100K
- Ra ≥80
- 100
- 10



světelné zdroje svetelné zdroje źródła światła

COB GU10

NOVINKA



A+



350lm



LED5WCOB-GU10/2700

370lm



LED5WCOB-GU10/4100



LED5WCOB-GU10/2700



8 590849 516005 1

LED5WCOB-GU10/4100



8 590849 516036 1



SMD GU10

NOVINKA



A+

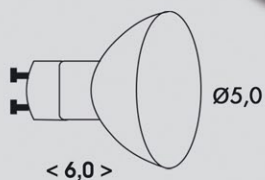

750lm



LED10W-GU10/2700

780lm



LED10W-GU10/4100



LED10W-GU10/2700



8 590849 519778 1

LED10W-GU10/4100



8 590849 519785 1



FRIGO LED

A+

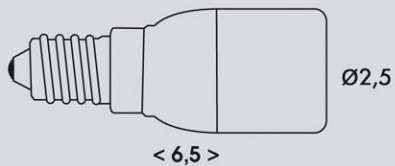

LED2W-TR/E14/4000



LED2W-TR/E14/4000



8 5 9 0 8 4 9 1 5 1 0 7 7 5 1



LED G9

A+

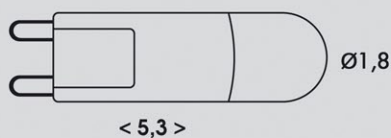

LED2,5W-G9/3000



LED2,5W-G9/4200



LED2,5W-G9/3000



8 5 9 0 8 4 9 1 5 1 2 3 0 4 1

LED2,5W-G9/4200



8 5 9 0 8 4 9 1 5 1 2 3 1 1 1



LED G9

A+

NOVINKA

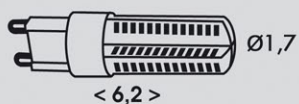

LED4,5W-G9/3000



LED4,5W-G9/4200



LED4,5W-G9/3000



8 5 9 0 8 4 9 1 5 1 7 2 3 1 1

LED4,5W-G9/4200



8 5 9 0 8 4 9 1 5 1 7 2 4 8 1





světelné zdroje svetelné zdroje źródła światła



SMD TUBE

A+

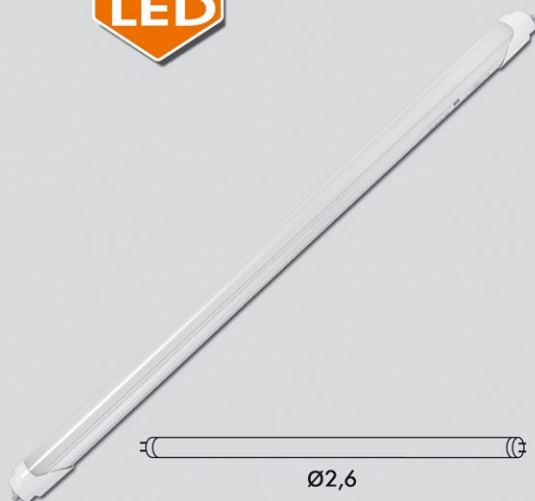

9W < 60,4 >

900lm

LEDTUBE-60/9W/4000/M



20W < 121,4 >

1600lm

LEDTUBE-120/20W/4000/M



24W < 151,4 >

2200lm

LEDTUBE-150/24W/4000/M



SMD TUBE

A+

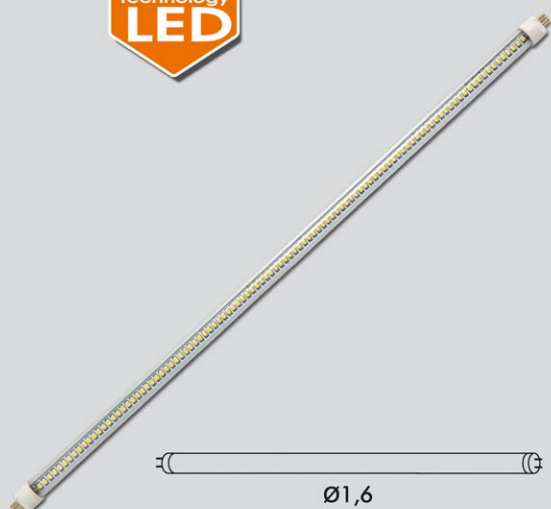

3,5W < 30,2 >

260lm

LEDTUBE-T5-60SMD/4100/C



6W < 53,1 >

440lm

LEDTUBE-T5-102SMD/4100/C



8,5W < 86,4 >

620lm

LEDTUBE-T5-144SMD/4100/C



LEDTUBE-T5-60SMD/4100/C

LEDTUBE-T5-102SMD/4100/C

LEDTUBE-T5-144SMD/4100/C



DZ

A



9W < 16,5 >

540lm

DZ-09

11W < 23,5 >

660lm

DZ-11



DZ-09



DZ-11



TUBE16/841

A

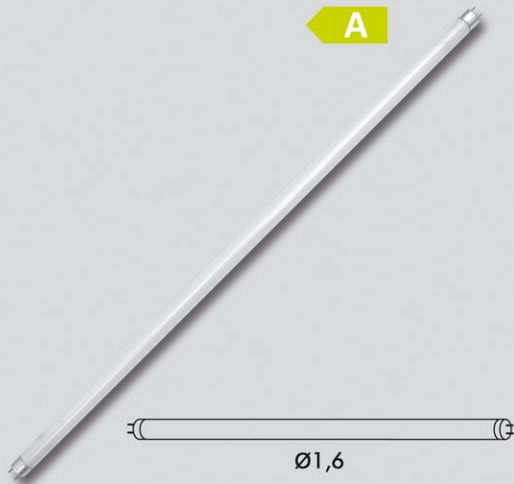

8W < 30,2 >

420lm

TUBE16-08/841/EU

13W < 53,1 >

840lm

TUBE16-13/841/EU

21W < 86,4 >

1220lm

TUBE16-21/841/EU



TUBE16-08/841/EU



TUBE16-13/841/EU



TUBE16-21/841/EU



TUBE26/841

A



10W < 34,5 >

550lm

TUBE26-10/841/EU

36W < 121,4 >

2750lm

TUBE26-36/841/EU

15W < 45,1 >

830lm

TUBE26-15/841/EU

58W < 151,4 >

3950lm

TUBE26-58/841/EU

18W < 60,4 >

1200lm

TUBE26-18/841/EU



TUBE26-10/841/EU



TUBE26-15/841/EU



TUBE26-18/841/EU



TUBE26-36/841/EU



TUBE26-58/841/EU



TUBECIRCO

A



22W < Ø18,0 >



TUBECIRCO-22W

32W < Ø25,0 >



TUBECIRCO-32W

40W < Ø28,0 >



TUBECIRCO-40W



TUBECIRCO-22W



TUBECIRCO-32W



TUBECIRCO-40W



JHQI

A

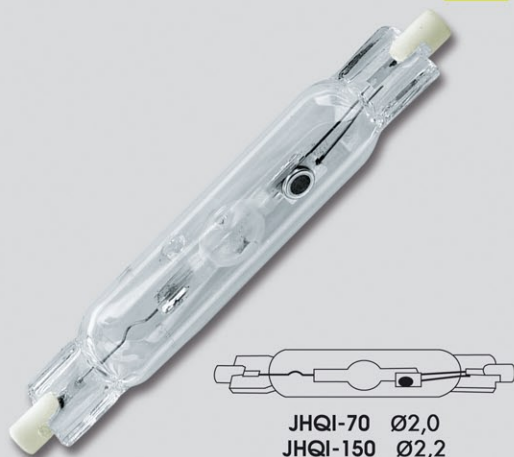

JHQI-70 Ø2,0
JHQI-150 Ø2,2

70W < 11,6 >



JHQI-70

150W < 13,4 >



JHQI-150



JHQI-70



JHQI-150



EHQI

A



Ø4,6

250W < 24,5 >



EHQI-250

400W < 26,5 >



EHQI-400



EHQI-250



EHQI-400



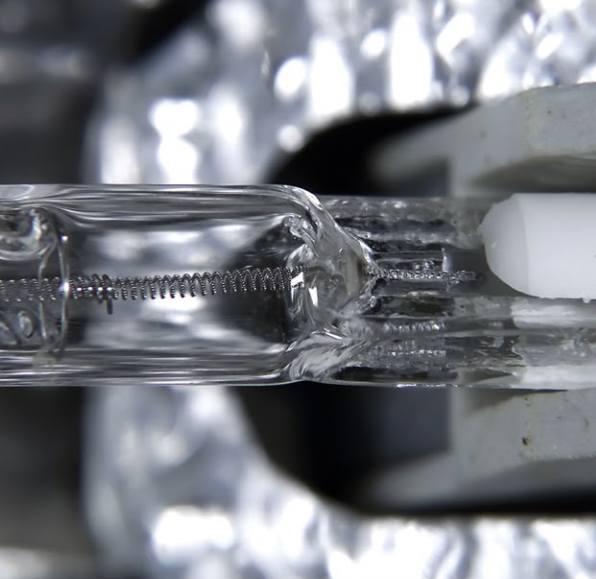

ECOlight

světelné zdroje svetelné zdroje źródła światła

ECO J

C



ECOJ78 < 7,8 >
ECOJ118 < 11,8 >

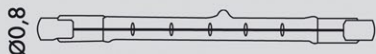

80W 1400lm



ECOJ78/80W

120W 2200lm



ECOJ78/120W

120W 2200lm



ECOJ118/120W

230W 3300lm



ECOJ118/230W

400W 8800lm



ECOJ118/400W



ECOJ78/80W



8 590849 505931

ECOJ78/120W



8 590849 505948

ECOJ118/120W



8 590849 505955

ECOJ118/230W



8 590849 505962

ECOJ118/400W



8 590849 505979



J

D



J78 < 7,8 >
J118 < 11,8 >
J189 < 18,9 >

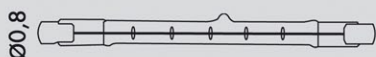

100W 1600lm



J100-78

150W 2400lm



J150-78

150W 2400lm



J150-118

300W 5400lm



J300-118

500W 10000lm



J500-118

1000W 21000lm



J1000-189



J100-78



8 590849 810783

J150-78



8 590849 815788

J150-118



8 590849 815184

J300-118



8 590849 830187

J500-118



8 590849 850185

J1000-189



8 590849 810899





světelné zdroje svetelné zdroje źródła światła

JC

D

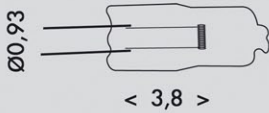

G4/10W
JC-10/G4 **140lm**

G4/20W
JC-20/G4 **350lm**

GY6,35/35W
JC-35/GY6,35 **650lm**

GY6,35/50W
JC-50/GY6,35 **950lm**



JC-10/G4
8 590849 804102

JC-20/G4
8 590849 804201

JC-35/GY6,35
8 590849 804355

JC-50/GY6,35
8 590849 804508



G9

D

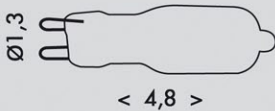
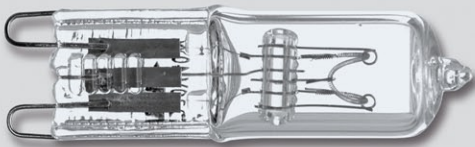

25W
G9-25CIR **180lm**

40W
G9-40CIR **360lm**

60W
G9-60CIR **600lm**



G9-25
8 590849 809251

G9-40
8 590849 809404

G9-60
8 590849 809602



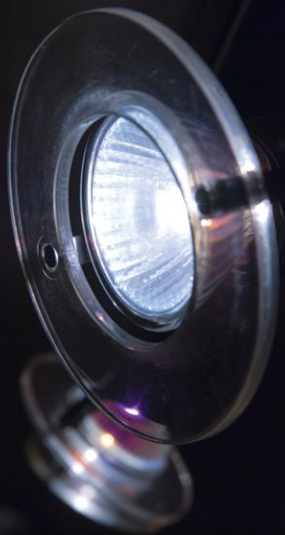

světelné zdroje svetelné zdroje źródła światła

GU10

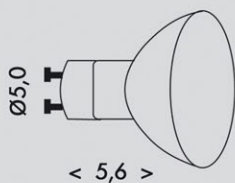

20W **400cd**



GU10-20

35W **600cd**



GU10-35

50W **1000cd**



GU10-50



GU10-20



GU10-35



GU10-50



MR16

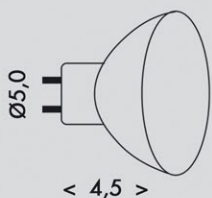

20W **460cd**



MR16-20

35W **1000cd**



MR16-35

50W **1450cd**



MR16-50



MR16-20



MR16-35



MR16-50





světelné zdroje
svetelné zdroje
źródła światła

E14 G9

D

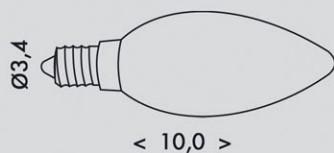
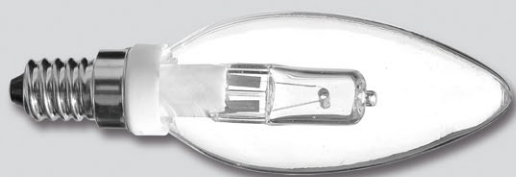

370lm



E14/G9/SV-28W

630lm



E14/G9/SV-42W



E14/G9/SV-28W



E14/G9/SV-42W



E14 G9

D

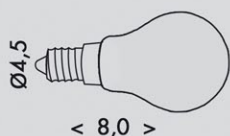

370lm



E14/G9/MB-28W

630lm



E14/G9/MB-42W



E14/G9/MB-28W



E14/G9/MB-42W





světelné zdroje svetelné zdroje źródła światła

E27 G9

D

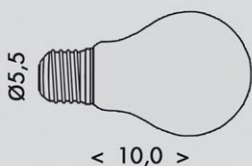

370lm



E27/G9-28W

630lm



E27/G9-42W

1350lm



E27/G9-75W



E27/G9-28W



E27/G9-42W



E27/G9-75W



R50 G9

R63 G9

D

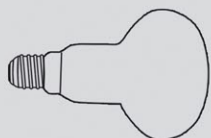

R50 - Ø5,0 < 8,7 >
R63 - Ø6,3 < 10,7 >

430lm



R50E14/G9-28W

900lm



R63E27/G9-42W



R50E14/G9-28W



R63E27/G9-42W





světelné zdroje svetelné zdroje źródła światła

R

E

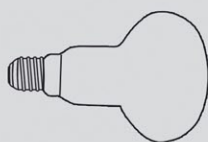

R50 - Ø5,0 < 8,3 >
R63 - Ø6,3 < 10,3 >

300lm



R50E14/25W

400lm



R50E14/40W

500lm



R63E27/40W

750lm



R63E27/60W



R50E14/25W



R50E14/40W



R63E27/40W



R63E27/60W



FRIGO

E



E14/15-TR/EU - Ø2,0 < 5,1 >
E14/40-TR/EU - Ø2,5 < 8,1 >

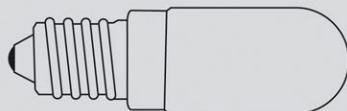

15W 150lm



E14/15-TR/EU

40W 400lm



E14/40-TR/EU



E14/15-TR/EU



E14/40-TR/EU



elektromateriál
elektromateriál
materiał elektryczny

Ecolite

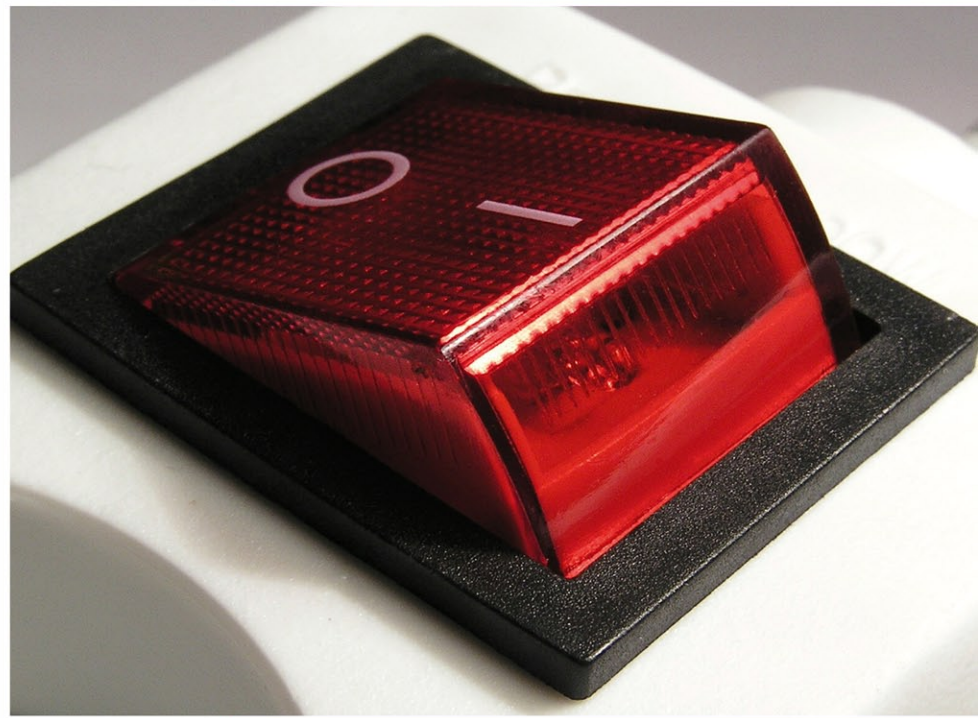

FK3



FK3-1.5 < 150,0 >
 FK3-3 < 300,0 >
 FK3-5 < 500,0 >



FK3-1.5



FK3-3



FK3-5



FK3-1.5



FK3-3



FK3-5



FK4



FK4-1.5 < 150,0 >
 FK4-3 < 300,0 >
 FK4-5 < 500,0 >



FK4-1.5



FK4-3



FK4-5



FK4-1.5



FK4-3



FK4-5



FK5



FK5-1.5 < 150,0 >
 FK5-3 < 300,0 >
 FK5-5 < 500,0 >



FK5-1.5



FK5-3



FK5-5



FK5-1.5



FK5-3



FK5-5



FX3



FX3-1.5	<	150,0	>
FX3-3	<	300,0	>
FX3-5	<	500,0	>
FX3-7	<	700,0	>
FX3-10	<	1000,0	>



FX3-1.5



FX3-3



FX3-5



FX3-7



FX3-10



FX4



FX4-1.5	<	150,0	>
FX4-3	<	300,0	>
FX4-5	<	500,0	>



FX4-1.5



FX4-3



FX4-5



FX5



FX5-1.5	<	150,0	>
FX5-3	<	300,0	>
FX5-5	<	500,0	>
FX5-7	<	700,0	>



FX5-1.5



FX5-3



FX5-5



FX5-7



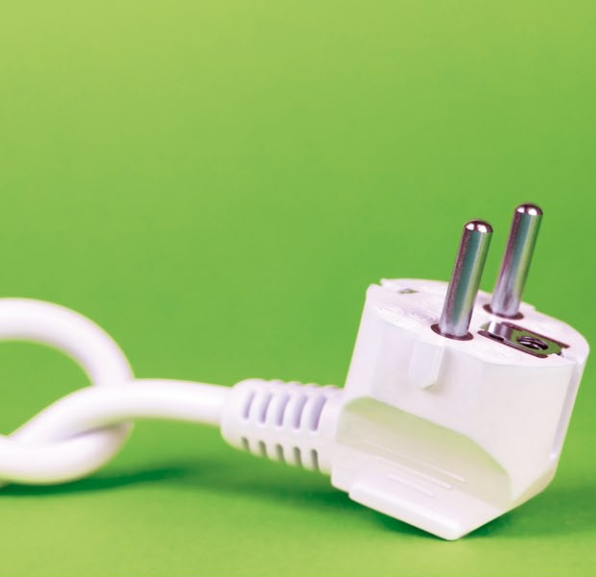

elektromateriál elektromateriál materiał elektryczny

FX1



- FX1-2 < 200,0 >
- FX1-3 < 300,0 >
- FX1-5 < 500,0 >
- FX1-7 < 700,0 >
- FX1-10 < 1000,0 >



2,0m

FX1-2



3,0m

FX1-3



5,0m

FX1-5



7,0m

FX1-7

max.
6A



10,0m

FX1-10

max.
6A



FX1-2



FX1-3



FX1-5



FX1-7



FX1-10



FX1



- FX1-15 < 1500,0 >
- FX1-20 < 2000,0 >
- FX1-25 < 2500,0 >
- FX1-30 < 3000,0 >



15,0m

FX1-15



20,0m

FX1-20



25,0m

FX1-25



30,0m

FX1-30



FX1-15



FX1-20



FX1-25



FX1-30





ecolite

elektromateriál
elektromateriál
materiál elektrický

FX1



FX1-25 3x1,5 < 2500,0 >
FX1-30 3x1,5 < 3000,0 >
FX1-40 3x1,5 < 4000,0 >



25,0m
FX1-25 3x1,5



40,0m
FX1-40 3x1,5



30,0m
FX1-30 3x1,5



FX1-25 3x1,5



FX1-30 3x1,5



FX1-40 3x1,5



FX1 B



FX1-20B < 2000,0 >



20,0m
FX1-20B



FX1-20B





elektromateriál
elektromateriál
materiál elektryczny

BUBEN



FBUBEN-25



BUBEN



FBUBEN-40



FBUBEN-50





elektromateriál elektromateriál materiál elektryczny

BUBEN IP44



25m



FBUBEN-25/IP44



FBUBEN-25/IP44



BUBEN IP44



40m



FBUBEN-40/IP44



FBUBEN-40/IP44



FBUBEN-50/IP44



50m



FBUBEN-50/IP44



UFON 4

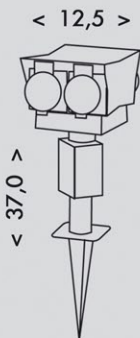

XHWS-F03



XHWS-F03



UFON 24

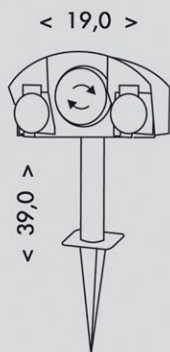

XHWS-F06



XHWS-F06



SOLITER 24

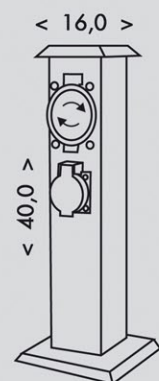

XSMM-202 FT



XSMM-202 FT





ecolite

elektromateriál
elektromateriál
materiál elektrický

STONE 2

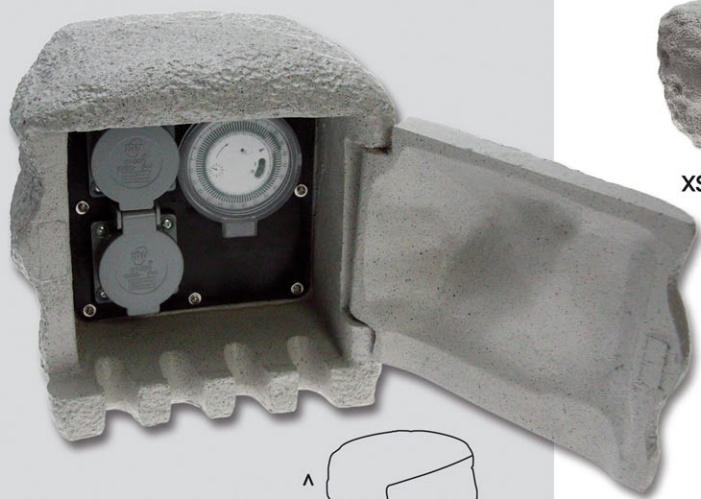

XSTA-222GT



XSTA-222GT



8 59 08 49 51 06 21 4

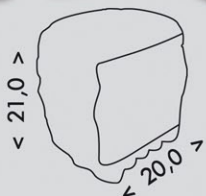

STONE 4

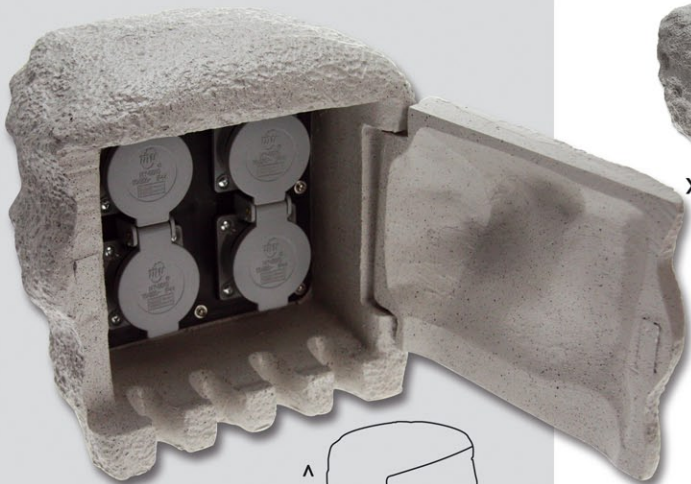

XSTA-224G



XSTA-224G



8 59 08 49 51 06 14 4



XKFZ



XKFZ-01/2+1T



XKFZ-01/3T



XKFZ-01/2+1T



XKFZ-01/3T



XKFZ B



XKFZB-1/3



XKFZB-1/3



XKFZ 5

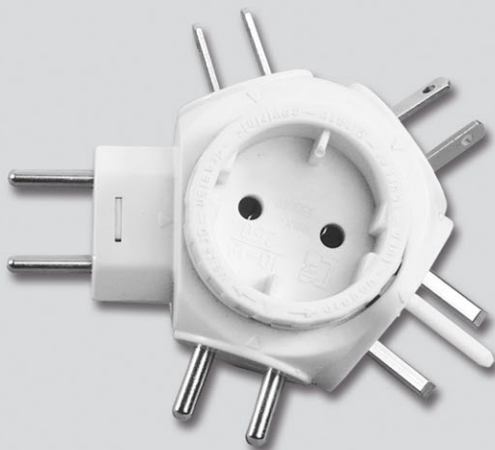

XKFZ-01/5



XKFZ-01/5



NOVINKA

X-USB



XJ4U-USB



NOVINKA

X-HOTEL



XQZ36-9

XQZ36-9



NOVINKA

X-USA



XQZ37-4/USA

XQZ37-4/USA



NOVINKA

X-UK



XQZ37-A/UK

XQZ37-A/UK



F1A
F1B



F1A



F1B



F1A



F1B



DRZAK



F-DRZAK/3



F-DRZAK/5



F-DRZAK/3



F-DRZAK/5



FKID



FKID



FKID



NOVINKA

SOCKET E14



ADAPT-E14/E27

ADAPT-E14/E27



NOVINKA

SOCKET E14

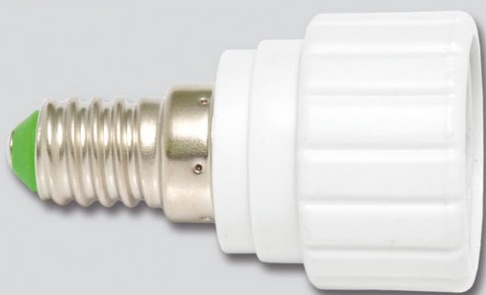

ADAPT-E14/GU10

ADAPT-E14/GU10



NOVINKA

SOCKET E27

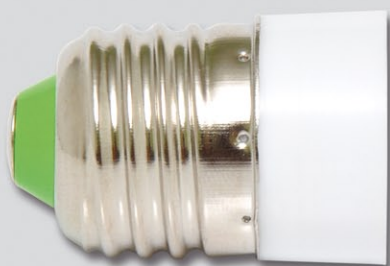

ADAPT-E27/E14

ADAPT-E27/E14



NOVINKA

SOCKET E27



ADAPT-E27/GU10

ADAPT-E27/GU10





elektromateriál elektromateriál materiał elektryczny

TIMER



X2A/1



X2A/1



DIGI TIMER



XDIG11



XDIG11





elektromateriál elektromateriál materiál elektryczny

REMOTE



EZ-7901



EZ-7901



SENZOR 140



EST01-BI



EST01-BI



SENZOR 360



EST05-BI



EST05-BI



SENZOR 360



EST40-BI



EST40-BI



SENZOR 360



EST41-BI



EST41-BI





elektromateriál elektromateriál materiál elektryczny

SENZOR HF



EST701-BI



EST701-BI



SENZOR 180



EST11-BI



EST11-BI



SOCKET E27



OBJIMKA-E27

OBJIMKA-E27



SOCKET E14



OBJIMKA-E14

OBJIMKA-E14



SOCKET GU10



OBJIMKA-GU10

OBJIMKA-GU10





elektromateriál elektromateriál materiał elektryczny

LED NIGHT

A+



XLED-NL/BI



XLED-NL/BI



LED NIGHT

A+



XESDEN-1W



XESDEN-1W





elektronika

elektromateriál
elektromateriál
materiál elektrický

SMOKE



XLX108A



XLX108A



< 4,5 >



Ø 11,4



STAR



XP200



XP200-ZAR/7W



XP200



XP200-ZAR/7W



zabezpečovací technika
zabezpečovacia technika
bezpieczeństwo technologia



CROWN

SC-8107-JU2

NOVINKA



SC-8107-JU2



8 5 9 0 8 4 9 1 5 1 9 9 5 2 1



4 kanálový bezdrátový kamerový systém s digitálním přenosem obrazu

- možnost připojení až 4 kamer, snadná bezdrátová instalace
- 7" palcový LCD monitor s integrovaným video rekordérem
- vestavěná lithiová baterie umožňuje přenosnost LCD panelu
- možnost vzdáleného připojení přes chytré zařízení s Android / iOS
- zápis na SD kartu (max. 32GB) nebo externí HDD (max. 1TB, USB2.0)
- nepřetržitý záznam s možností přepisu záznamu
- možnost nastavení záznamu (dle času popř. aktivace PIR senzorem)
- dosah "nočního vidění" až 20m
- kvalita záznamu 4CH VGA 10fps, 1CH VGA 30fps
- voděodolné robustní kamery s možností venkovního použití (IP66)
- s dosahem až 300m (v otevřeném prostoru)
- video výstup pro připojení monitoru



4 kanálový bezdrátový kamerový systém s digitálnym prenosom obrazu

- možnost připojení až 4 kamer, jednoduchá bezdrátová instalace
- 7" palcový LCD monitor s integrovaným video rekordérom
- zabudovaná lithiová batéria pre prenosnosť LCD panela
- možnost vzdáleného připojení cez smart zariadenie s Androids / iOS
- zápis na SD kartu (max. 32GB) alebo externí HDD (max. 2TB, USB2.0)
- nepřetržitý záznam s možnosťou prepisu záznamu
- možnost nastavení záznamu (podľa času popr. aktivácia PIR senzorem)
- dosah "nočného videnia" až 5m
- kvalita záznamu 4CH VGA 10fps, 1CH VGA 30fps
- vodotesné robustné kamery s možnosťou vonkajšieho použitia (IP66)
- s dosahom až 300m (v otvorenom priestore)
- video výstup pre pripojenie monitoru



SC-8107-GD

NOVINKA



SC-8107-GD



8 5 9 0 8 4 9 1 5 1 9 9 6 9 1





zabezpečovací technika
zabezpečovacia technika
bezpečnosť technológia

DVK-7304S-AC

DVK-7304S-AC



4 kanálový kamerový systém

- sledování v reálném čase
 - pohled z jedné kamery / všech čtyř kamer
 - nahrávání záznamu z kamer na HDD 250GB (součástí dodávky)
 - vestavěný alarm - detekce pohybu, ztráta signálu, plný disk
 - optimalizovaná komprese - komprese/dekomprese v H264 algoritmu
 - ochrana heslem (dvoj úrovněová)
 - automatická obnova po výpadku napájení
 - funkce vzdálené správy – podpora web prohlížeče
- Snadné ovládání: pc myš, čelní panel



4 kanálový kamerový systém

- sledovanie v reálnom čase
 - pohľad z jednej kamery / všetkých štyroch kamier
 - nahrávanie záznamu z kamier na HDD 250GB (súčasťou dodávky)
 - vstavaný alarm – detekcia pohybu, strata signálu, plný disk
 - optimalizovaná kompresia – kompresia/dekompresia v H264 algoritmu
 - ochrana heslom (dvoj úrovněová)
 - automatická obnova po vypnutí napájania
 - funkcia vzdialenej správy – podpora web prehliadača
- ľahké ovládanie: pc myš, čelný panel



1x

1x

4x





CROWN

zabezpečovací technika
zabezpečovacia technika
bezpieczeństwo technologia

XSL1008

NOVINKA

XSL1008



Fotopast pro venkovní použití na SD kartu

- rozlišení snímků až 12 Mpix, zaostření 1,5 m až nekonečno
- rozlišení videa max. HD 720p, délka každého videa až 10 sec.
- nahrávání se zvukem
- obrazový snímač CMOS
- PIR pohybový senzor s detekcí 48 st až do 20m
- infračervený LED přísvit pro neviditelné noční snímání
- podporuje SD karty s max. kapacitou 32 GB, Class 10
- na snímcích uveden datum / čas/ teplota
- AV výstup pro připojení k TV
- stupeň krytí IP66
- napájení: 8ks AA baterií (nejsou součástí balení)

Obsah balení:

fotopast - záznamové zařízení
montážní popruh
propojovací USB kabel
uživatelská příručka



Fotopasca na vonkajšie použitie na SD kartu

- rozlíšenie snímkov až 12 Mpix, zaostrenie 1,5 m až nekonečno
- rozlíšenie videa max. HD 720p, dĺžka videa až 10 sec.
- nahrávanie so zvukom
- obrazový snímač CMOS
- PIR pohybový senzor s detekciou 48 st až do 20m
- infračervené LED prísivlenie pre neviditeľné nočné snímání
- podporuje SD karty s max. kapacitou 32 GB, Class 10
- na snímkach uvádza dátum / čas/ teplotu
- AV výstup na pripojenie k TV
- stupeň krytia IP66
- napájanie: 8ks AA batérií (nie sú súčasťou balenia)

Obsah balenia:

fotopasca - záznamové zariadenie
montážny popruh
prepájací USB kábel
uživatelská príručka





zabezpečovací technika
zabezpečovacia technika
bezpieczeństwo technologia

XSL8210

NOVINKA

XSL8210



8 5 9 0 8 4 9 1 5 1 8 7 5 7 1



GSM fotopast pro venkovní použití na SD kartu, funkce odesílání MMS a emailů

- rozlišení snímků až 12 Mpix, zaostření 1,5 m až nekonečno
- rozlišení videa max. HD 720p, délka každého videa až 60 sec.
- nahrávání se zvukem
- funkce odesílání MMS nebo emailů na 3 kontakty
- obrazový snímač CMOS se zorným úhlem 120 st.
- LCD monitor vel. 2,36"
- integrovaná GSM anténa
- PIR pohybový senzor s detekcí 100 st. až do 20m
- infračervený LED přísvit pro neviditelné noční snímání
- podporuje SD karty s max. kapacitou 32 GB, Class 10
- na snímcích uveden datum / čas/ teplota
- AV výstup pro připojení k TV
- stupeň krytí IP54
- napájení: 8ks AA baterií (nejsou součástí balení)

Obsah balení:

Fotopast - záznamové zařízení
montážní popruh
propojovací USB kabel
AV kabel pro TV výstup (cinch)
uživatelská příručka + záruční list
instalační CD s aplikací pro nastavení MMS



GSM fotopasca na vonkajšie použitie na SD kartu, funkcie odosielania MMS a emailov

- rozlíšenie snímkov až 12 Mpix, zaostrenie 1,5 m až nekonečno
- rozlíšenie videa max. HD 720p, dĺžka videa až 60 sec.
- nahrávanie so zvukom
- funkcia odosielania MMS alebo emailov na 3 kontakty
- obrazový snímač CMOS so zorným uhlom 120 st.
- LCD monitor 2,36"
- integrovaná GSM anténa
- PIR pohybový senzor s detekciou 100 st. až do 20m
- infračervené LED prísvitovanie pre neviditeľné nočné snímání
- podporuje SD karty s max. kapacitou 32 GB, Class 10
- na snímkach uvádza dátum / čas/ teplotu
- AV výstup na pripojenie k TV
- stupeň krytí IP54
- napájanie: 8ks AA batérií (nie sú súčasťou balenia)

Obsah balení:

Fotopasca - záznamové zariadenie
montážny popruh
prepájací USB kábel
AV kábel pre TV výstup (cinch)
uživatelská príručka + záručný list
inštaláčne CD s aplikáciou na nastavenie MMS





zabezpečovací technika zabezpečovacia technika bezpieczeństwo technologia

DV130C

NOVINKA

DV130C



Outdoorová Full HD kamera na SD kartu, voděodolná (30m) s ultra širokou skleněnou čočkou a vestavěným mikrofónem

- rozlišení 1920 × 1080 - 30fps, 12 Mpx, LCD displej
- na výběr video formáty 1080P, 720P, WVG
- fotoaparát - různé možnosti režimů focení
- ukládání záznamu do formátu H.264 MOV
- podporuje SD karty s max. kapacitou 32 GB, Class 10, min. 30 MB/s
- HDMI výstup
- napájení 900 mAh lithium baterie (umožní až 1,5 hod záznamu)
- WiFi pro připojení k chytrému telefonu nebo tabletu
- stupeň krytí IP68 (v pouzdru)

Příslušenství:

- voděodolné pouzdro
- různé druhy základen, klipů, 3M páska
- držák pro přichycení k helmě a říditkám
- USB kabel
- síťový adaptér pro dobíjení
- speciální čisticí hadřík
- uživatelská příručka



Outdoorová Full HD kamera na SD kartu, vodotesná (30m) s ultra širokou skleněnou šošovkou a zabudovaným mikrofónom

- rozlišení 1920 × 1080 - 30fps, 12 Mpx, LCD displej
- na výběr video formáty 1080P, 720P, WVG
- fotoaparát - různé možnosti režimov fotenia
- ukládanie záznamu do formátu H.264 MOV
- podporuje SD karty s max. kapacitou 32 GB, Class 10, min. 30 MB/s
- HDMI výstup
- napájanie 900 mAh lithium batéria (umožní až 1,5 hod záznamu)
- WiFi pre pripojenie k smartphonu alebo tabletu
- stupeň krytia IP68 (v puzdre)

Príslušenstvo:

- vodotesné puzdro
- rôzne druhy základní, klipov, 3M páska
- držiak na uchycenie k helmě alebo bicyklu
- USB kábel
- sietový adaptér na dobíjanie
- špeciálna čistiacia handrička
- uživatelská príručka





CROWN

zabezpečovací technika
zabezpečovacia technika
bezpieczeństwo technologia

HF-GSM04

HF-GSM04



Bezdrátový GSM alarm vč. aplikace pro chytré zařízení

- snadná instalace a ovládání systému pomocí chytrého mobilního telefonu s Android / iOS
- naskenováním QR kódu si pohodlně stáhnete aplikaci do svého mobilního telefonu
- automatické telefonické oznámení alarmu až na 6 čísel
- automatické SMS oznámení alarmu na dalších až 6 čísel
- SOS tlačítko na dálkovém ovladači
- dálkové zapnutí/vypnutí alarmu pomocí mobilního telefonu
- upozornění SMS zprávou na výpadek elektrického proudu a jeho opětovného zapnutí
- upozornění SMS zprávou na neobvyklou změnu teploty uvnitř objektu
- vestavěný akumulátor zabezpečí provoz cca 6 hodin při výpadku elektrického proudu
- centrální jednotka obsahuje interní mikrofon, který vám umožní slyšet co se v objektu děje
- centrála obsahuje vestavěný reproduktor - narušitel objektu uslyší, co říkáte do svého telefonu
- na centrální jednotce alarmu lze nastavit budík



Bezdrôtový GSM alarm vrátane aplikácie pre smartphone

- ľahká inštalácia a ovládanie systému pomocou smartphonu s Android / iOS
- naskenovaním QR kódu si pohodlne stiahnete aplikáciu do svojho telefónu
- automatické telefonické oznámenie alarmu až na 6 čísel
- automatické SMS oznámenie alarmu na ďalších až 6 čísel
- SOS tlačidlo na diaľkovom ovládači
- diaľkové zapnutie / vypnutie alarmu pomocou mobilného telefónu
- upozornenie SMS správou na výpadok elektrického prúdu a jeho opätovné zapnutie
- upozornenie SMS správou na neobvyklú zmenu teploty vnútri objektu
- zabudovaný akumulátor zabezpečí pri výpadku prúdu prevádzku cca 6 hodín
- centrálna jednotka obsahuje interný mikrofón, ktorý vám umožní počuť, čo sa deje v objekte
- centrála obsahuje zabudovaný reproduktor – narušiteľ objektu bude počuť, čo hovoríte do svojho telefónu
- na centrálnej jednotke alarmu je možné nastaviť budík



Pohybové čidlo



Okenní senzor



Dveřní senzor





zabezpečovací technika zabezpečovacia technika bezpieczeństwo technologia

HF-GSM01B

HF-GSM01B



- Bezdrátový GSM alarm**
- velmi snadná a rychlá bezdrátová instalace
 - automatické telefonní oznámení alarmu až na 6 čísel
 - automatické SMS oznámení alarmu
 - snadné ovládání systému pomocí dálkových ovladačů
 - SOS tlačítko na dálkovém ovladači
 - dálkové zapnutí/vypnutí alarmu pomocí mobilního telefonu
 - vestavěný akumulátor pro provoz při výpadku el. proudu

- Bezdrôtový GSM alarm**
- veľmi ľahká a rýchla bezdrôtová inštalácia
 - automatické telefónne oznámenie alarmu až na 6 čísel
 - automatické SMS oznámenie alarmu
 - ľahké ovládanie systému pomocou diaľkových ovládačov
 - SOS tlačítko na diaľkovom ovládači
 - Diaľkové zapnutie / vypnutie alarmu pomocou mobilného telefónu
 - Vstavaný akumulátor na prevádzku pri výpadku elektrického prúdu

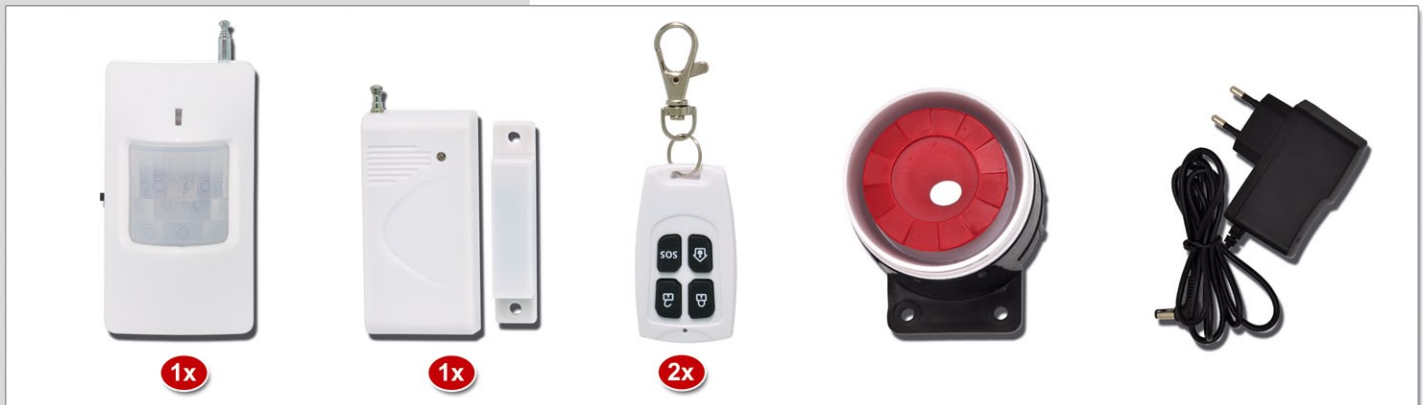
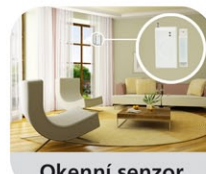



zabezpečovací technika zabezpečovacia technika bezpieczeństwo technologia

HF-GSM03

HF-GSM03



Bezdrátový GSM alarm

- velmi snadná a rychlá bezdrátová instalace
- automatické telefonní oznámení alarmu až na 6 čísel
- automatické SMS oznámení alarmu až na 3 čísla
- snadné ovládání systému pomocí dálkových ovladačů
- SOS tlačítko na dálkovém ovladači
- dálkové zapnutí/vypnutí alarmu pomocí mobilního telefonu
- upozornění SMS zprávou na výpadek elektrického proudu
- vestavěný akumulátor pro provoz při výpadku el. proudu
- možnost provedení telefonního hovoru z centrály
- možnost jednoduchého doplnění o další bezdrátové senzory



Bezdrátový GSM alarm

- veľmi ľahká a rýchla bezdrôtová inštalácia
- automatické telefónne oznámenie alarmu až na 6 čísel
- automatické SMS oznámenie alarmu až na 3 čísla
- ľahké ovládanie systému pomocou diaľkových ovládačov
- SOS tlačítko na diaľkovom ovladači
- Diaľkové zapnutie / vypnutie alarmu pomocou mobilného telefónu
- Upozornenie SMS správou na výpadok elektrického prúdu
- Vstavaný akumulátor na prevádzku pri výpadku elektrického prúdu
- Možnosť vykonania telefónneho hovoru z centrály
- Možnosť jednoduchého doplnenia o ďalšie bezdrôtové senzory



Pohybové čidlo



Okenní senzor



Dveřní senzor

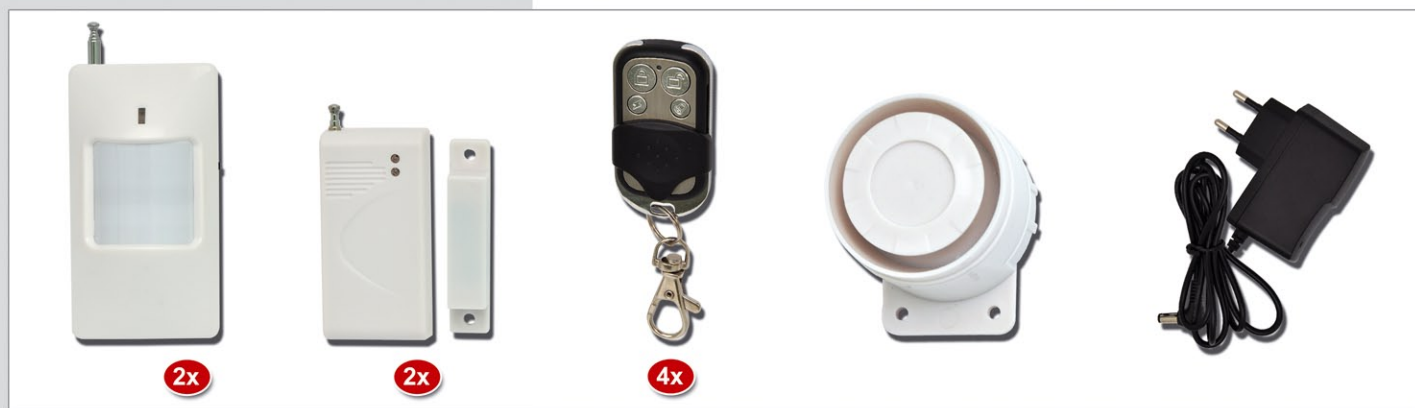



PIR

HF-EST20-BI



HF-EST20-BI



DOOR

HF-25D



HF-25D



KEYPAD

HF-28WK



HF-28WK



SMOKE



HF-28WS

HF-28WS



85908491509137



GAS



HF-30WG

HF-30WG



85908491509144



SIRENA



HF-48WS-A

HF-48WS-A



85908491509151



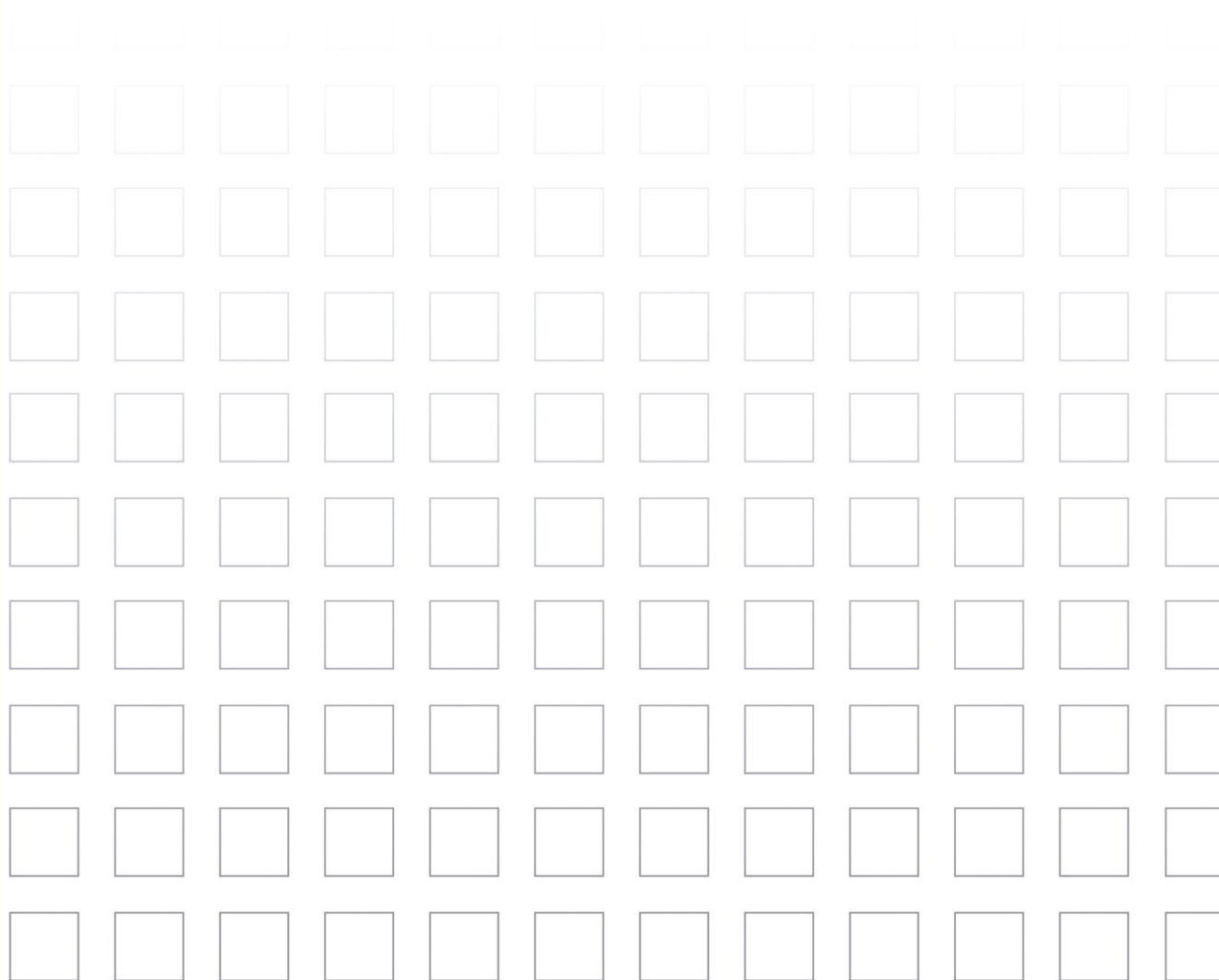

Ecolite

stolní lampy
stolné lampy
lampy stołowe





stolní lampy
stolné lampy
lampy stołowe

STAR

A+

NOVINKA

technology
LED

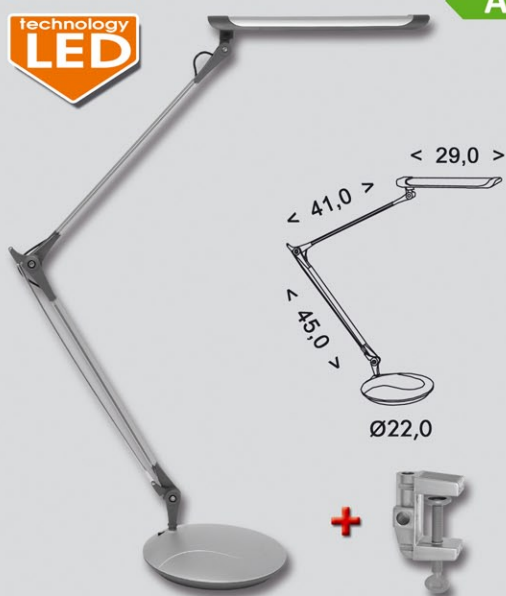

590lm



LTZ02-STR



LTZ02-STR



8 59 08 49 15 14 70 4

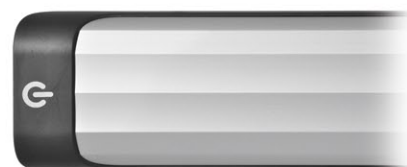

VIVA

A+

NOVINKA

technology
LED



310lm



LTZ03-BI

310lm



LTZ03-CR



LTZ03-BI



8 59 08 49 15 14 72 8

LTZ03-BI



8 59 08 49 15 16 72 2



NOVINKA
technology
LED

MATRIX

A+



600lm



LBL1207-BI

600lm



LBL1207-CR

600lm



LBL1207-STR



LBL1207-BI



LBL1207-CR



LBL1207-STR



NOVINKA

EMA

A+

technology
LED



280lm



LBL1392-BI

280lm



LBL1392-CV

280lm



LBL1392-STR



LBL1392-BI



LBL1392-CV



LBL1392-STR



NOVINKA

LUPA

A+

technology
LED

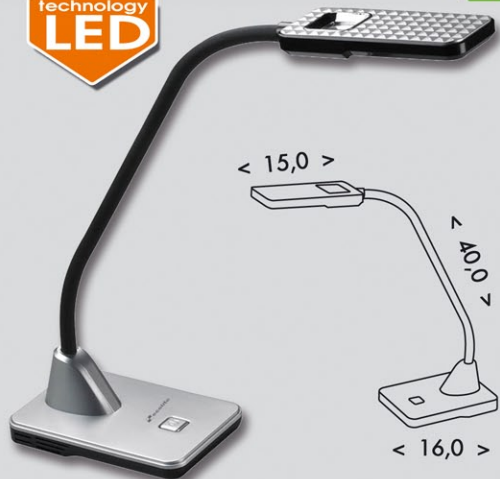

280lm



LBL1856-BI

280lm



LBL1856-CV

280lm



LBL1856-STR



LBL1856-BI



LBL1856-CV



LBL1856-STR



SPEKTRA

D

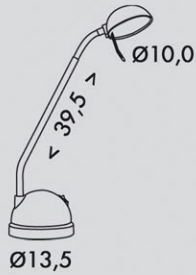

L460-BI



L460-CR



L460-STR



L460-BI



L460-CR



L460-STR



KARO

A - D

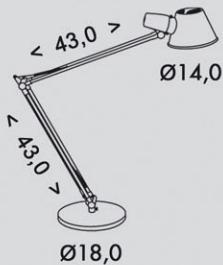

L202-STR



L202-STR



ADEPT

A

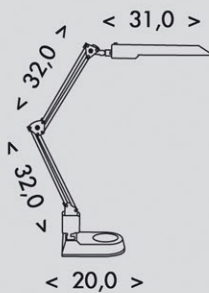

L50164-BI



L50164-CR



L50164-STR



L50164-BI



L50164-CR



L50164-STR





stolní lampy
stolné lampy
lamps stołowe

LISA

A+

NOVINKA

technology
LED



280lm



L215B-BI

280lm



L215B-CR

280lm



L215B-CV

280lm



L215B-MO

280lm



L215B-ZLU



L215B-BI



L215B-CR



L215B-CV



L215B-MO



L215B-ZLU



LISA

A+

NOVINKA

technology
LED



280lm



L215C-BI

280lm



L215C-CR

280lm



L215C-CV

280lm



L215C-MO

280lm



L215C-ZLU



L215C-BI



L215C-CR



L215C-CV



L215C-MO



L215C-ZLU





stolní lampy
stolné lampy
lampy stołowe

TINA

A - D

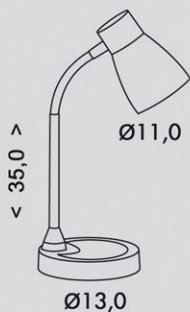

L2705-MO



L2705-STR



L2705-ORA



L2705-ZE



L2705-RUZ



L2705-ZLU

L2705-MO



8 590849 504071

L2705-STR



8 590849 504095

L2705-ORA



8 590849 504125

L2705-ZE



8 590849 504101

L2705-RUZ



8 590849 504279

L2705-ZLU



8 590849 504118



BOND

A - D

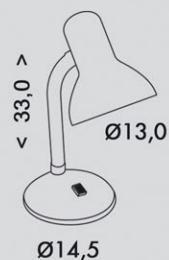

L077-BI



L077-MO



L077-CR



L077-STR



L077-CV



L077-MIX

L077-BI



8 590849 000771

L077-MO



8 590849 000863

L077-CR



8 590849 000856

L077M-STR



8 590849 000788

L077-CV



8 590849 000818

L077-MIX



8 590849 000825





stolní lampy stolné lampy lampy stołowe

PLEXI

A - D



L078-BI



L078-CR



L078-CV



L078-BI



L078-CR



L078-CV



BONY

D



L111-CR



L111-STR



L111-CR



L111-STR





Ecolite

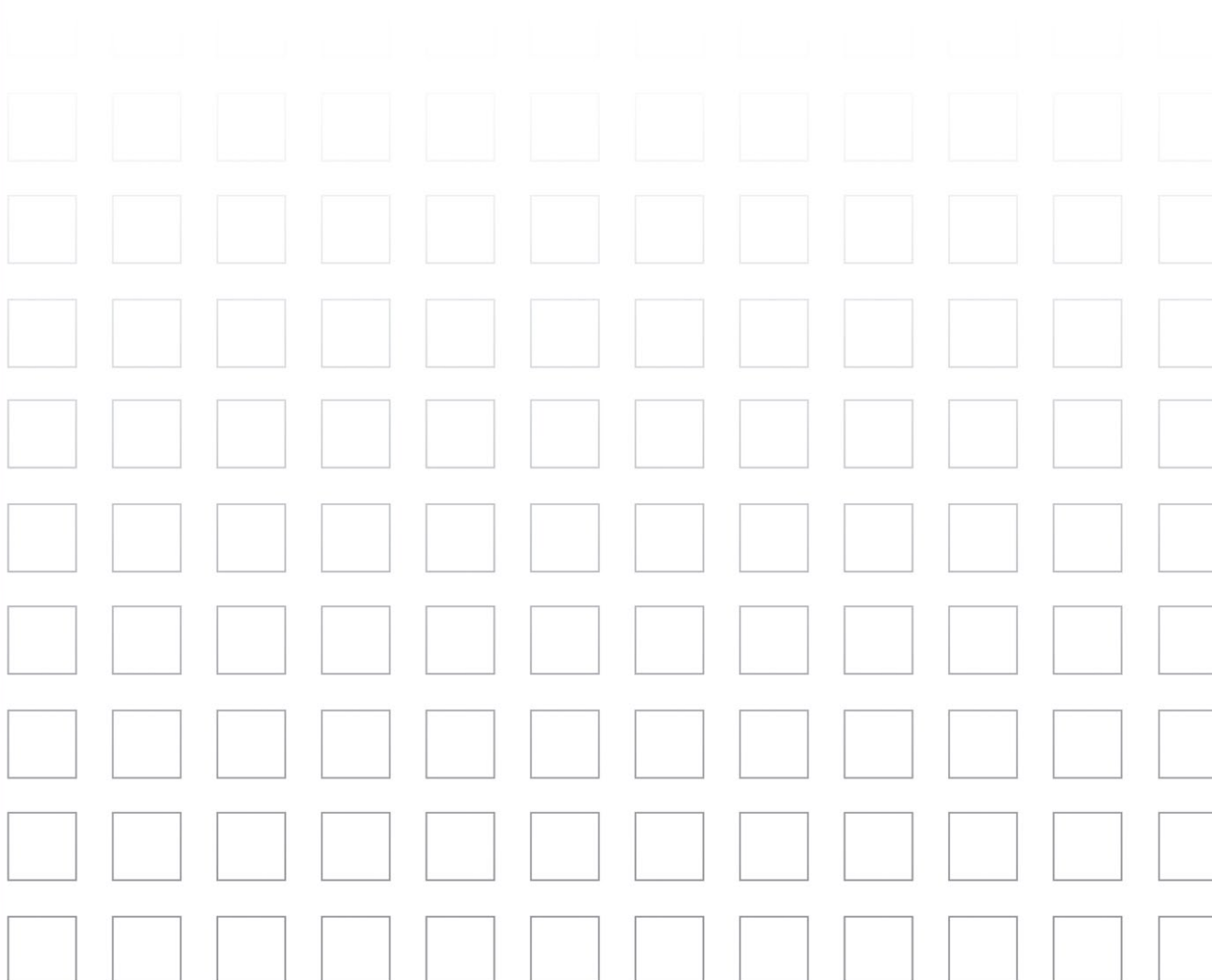

stojací lampy
stojanové lampy
lampy stojące

ecolite





stojací lampy
stojanové lampy
lampy stojące

DUHA

A - D



LF34-BI/CHRM



LF34-MO/CHRM

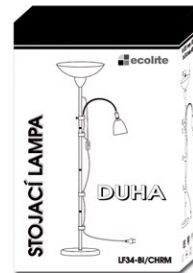

LF34-BI/CHRM



LF34-MO/CHRM





stojací lampy
stojanové lampy
lampy stojące

DUHA

A - D



LF34-ZLU/CHR



LF34-ORA/PAT

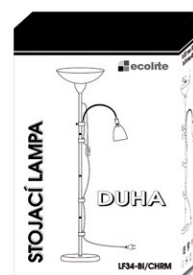

LF34-ZLU/CHR



LF34-ORA/PAT



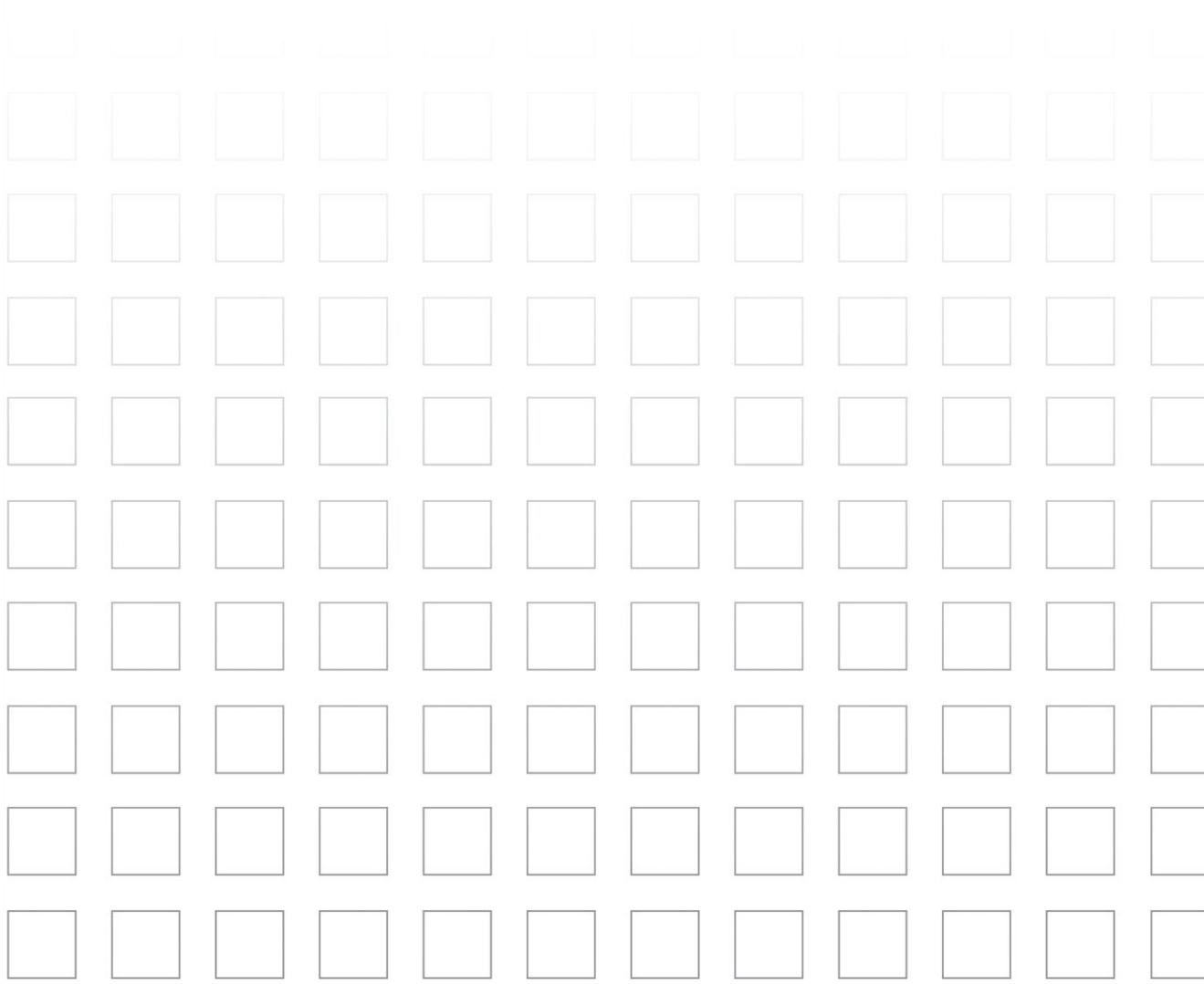

nástěnky
nástenky
kinkiety

ecolite

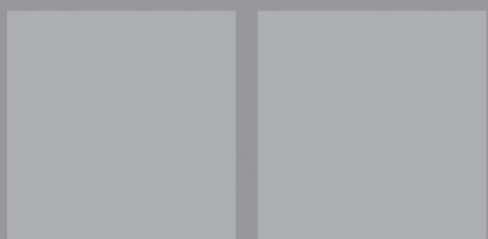

JUNO

A - D



Ø30,0



W11-BI

W11-BI



8590849031102



JUVO

A - D

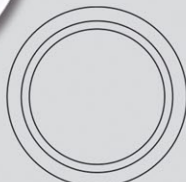

W21 Ø30,0
W31 Ø40,0



W21-BI



W31-BI

W21-BI



8590849032109

W31-BI



8590849033106



ECONOMY

A - D

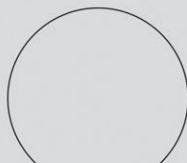

Ø25,0



W20-BI

W20-BI



8590849033014



lustry
lustre
lampy

ecolite





ecolite

lustry lustre lamps

GLOBE



DHL400-12 Ø30,0
DHL400-16 Ø40,0
DHL400-20 Ø50,0
DHL400-24 Ø60,0



DHL400-12



DHL400-24



DHL400-16



DHL400-20

DHL400-12



DHL400-16



DHL400-20



GLOBE 2



DHL400-16 Ø40,0



DHL400-16/MO



DHL400-16/ZLU



DHL400-16/ORA



DHL400-16/MO



DHL400-16/ZLU



DHL400-16/ORA





lustry lustre lamps

BALL



Ø40,0



DHL35



DHL35



8 590849 1100358



ELIPSE

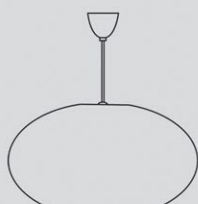

Ø52,0



DHL4552



DHL4552



8 590849 1104523





lustry lustre lamps

ZAVES



>
70,0
<



MATZAVES-PAP



MATZAVES-PAP



8 590849 100112



venkovní světla
vonkajšie svetlá
lamps zewnętrzne

ecolite





venkovní světla vonkajšie svetlá lamps zewnętrzne



Z6101-BI



Z6101-CR



Z6101-PAT



Z6101-BI



Z6101-CR



Z6101-PAT



Z6102-BI



Z6102-CR



Z6102-PAT



Z6102-BI



Z6102-CR



Z6102-PAT





venkovní světla vonkajšie svetlá lamps zewnętrzne



KLASIK

A - D

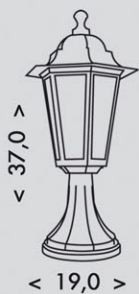

Z6104-BI



Z6104-CR



Z6104-PAT



Z6104-BI



Z6104-CR



Z6104-PAT



KLASIK

A - D



Z6105-BI



Z6105-CR



Z6105-PAT



Z6105-BI















Z6105-CR



Z6105-PAT



	značka shody s předpisy EU značka zhody s predpismi EU znak bezpieczeństwa zgodny dyrektywą unijną		halogenová žárovka JDR; závit E14 halogénová žiarovka JDR; závit E14 halogenowa żarówka JDR; gwint E14
	střídavé napětí 230V striedavé napätie 230V napięcie zasilania 230V		halogenová žárovka GU10 halogénová žiarovka GU10 halogenowa żarówka GU 10
	napětí 12V napätie 12V napięcie 12V		halogenová žárovka MR16 halogénová žiarovka MR16 halogenowa żarówka MR16
	třída I ochrany před el. proudem-svítilno musí být uzemněno. trieda I ochrany pred el. prúdom-svietidlo musí byť uzemnené konieczność ochrony przed el. prądem-lampa musi być uziemiona		halogenová žárovka JC halogénová žiarovka JC halogenowa żarówka JC
	třída II ochrany před el. proudem-dvojitá izolace; není třeba uzemňovat trieda II ochrany pred el. prúdom-dvojitá izolácia; nie je treba uzemňovať klasa II ochrany przed el. prądem-podwójna izolacja, niepotrzeba uziemiać		halogenová žárovka G9 halogénová žiarovka G9 halogenowa żarówka G9
	třída III ochrany před el. proudem-nízkonapěťové svítidlo (SELV) trieda III ochrany pred el. prúdom-nízkonapätové svetidlo (SELV) klasa III ochrany przed el. prądem-nisko napięciowa lampa		halogenová dvoupaticová lineární žárovka J - délka v mm halogénová dvojpäticová lineárna žiarovka J - dĺžka v mm żarówka halogenowy liniowy typu J w mm
	lze montovat na normálně hořlavé povrchy je možné montovať na normálne horľavé povrchy można montować na łatwopalnym podłożu		metalhalogenidová dvoupaticová lineární výbojka metalhalogenidová dvojpäticová lineárna výbojka metalhalogenidowa liniowa żarówka
	maximální povolený výkon použité žárovky maximální povolený výkon použité žiarovky maksymalna moc żarówki		metalhalogenidová jednopaticová lineární výbojka metalhalogenidová jednopäticová lineárna výbojka metalhalogenidowa liniowa żarówka
	maximální povolený jmenovitý proud maximální povolený menovitý prúd maksymalny znamionowy prąd		světloemittující dioda svetloemitujúca dioda dioda typu LED
	určeno pro použití v interieru určené pre použitie v interiéri przeznaczono do użytku wewnątrz		nízkonapěťová žárovka T-15 niskonapätová žiarovka T-15 nisko napięciowa żarówka T-15
	určeno pro použití v exteriéru určené pre použitie v exteriéri przeznaczono do użytku na zewnątrz		trubice s ultrafialovým světlem trubica s ultrafialovým svetlom ultrafioletowa jarzeniówka
	určeno pro použití v interieru i exteriéru určené pre použitie v interiéru aj exteriéri przeznaczono do użytku zewnętrznego i wewnątrz		objímka E27 - velký závit objímka E27 - velký závit opravka E27- duzy gwint
	minimální vzdálenost od osvětlovaného objektu minimalna vzdialenost od osvetľovaného objektu minimalna odległość od świecającego obiektu		objímka E14 - malý závit objímka E14 - malý závit opravka E14 - mały gwint
	střední doba životnosti světelného zdroje udávaná v hodinách stredná doba životnosti svetelného zdroja udávaná v hodinách żywotność świetlnego źródła w godzinach		objímka pro zářivkovou trubici T8 objímka pre žiarivkovú trubicu T8 opravka jarzeniówki T8
	barva světla (teplota chromatičnosti); jednotka kelvin; <3300K-teplé světlo, 3300-5300K-bílé světlo, >6400-denní světlo farba svetla (teplota chromatičnosti); jednotka kelvin; <3300K-teplé svetlo, 3300-5300K-biele svetlo, >6400-denné svetlo barwa światła; jednostka kelvin; < 3300K-ciepłe światło, 3300-5300K-białe światło, >6400 dzienne światło		objímka pro zářivkovou trubici T5 objímka pre žiarivkovú trubicu T5 opravka jarzeniówki T5
	standardní žárovka štandardná žiarovka standartowa żarówka		objímka pro jednopaticovou halogenovou žárovku JC-G4 objímka pre jednopäticovú halogénovú žiarovku JC-G4 opravka halogenowej żarówki JC-G4
	standardní žárovka s malou baňkou štandardná žiarovka s malou bankou standartowa żarówka z małą bańką		objímka pro jednopaticovou halogenovou žárovku JC-G5,3 objímka pre jednopäticovú halogénovú žiarovku JC-G5,3 opravka halogenowej żarówki JC-G5,3
	standardní žárovka ve tvaru svíčky štandardná žiarovka v tvare sviečky standartowa żarówka z bańką- świeczka		objímka pro jednopaticovou halogenovou žárovku JC-G6,35 objímka pre jednopäticovú halogénovú žiarovku JC-G6,35 opravka halogenowej żarówki JC-G6,35

-  reflektorová žárovka R50 se závitem E14
reflektorová žiarovka R50 so závitom E14
reflektorowa żarówka R50 z gwintem E14
-  reflektorová žárovka R63 se závitem E27
reflektorová žiarovka R63 so závitom E27
reflektorowa żarówka R63 z gwintem E27
-  jednopaticová zářivková trubice DZ/PL
jednopäticová žiarivková trubica DZ/PL
jarzeniówka typu DZ/PL
-  dvoupatcová lineární zářivka T5-průměr 16mm
dvojpäticová lineárna žiarivka T5-priemer 16mm
jarzeniówka T5 - o średnicy 16 mm
-  dvoupatcová lineární zářivka T8-průměr 26mm
dvojpäticová lineárna žiarivka T8-priemer 26mm
jarzeniówka T8-o średnicy 26 mm
-  kompaktní zářivka s elektronickým předřadníkem
kompaktná žiarivka s elektronickým predradníkom
kompaktowa żarówka z elektronicznym zaplonem
-  světelný zdroj je součástí svítidla
svetelný zdroj je súčasťou svietidla
źródło światła w komplecie
-  balení - počet kusů v kartonu
balenie - počet kusov v kartóne
opakowanie - ile sztuk w kartonie
-  součástí svítidla je elektronický předřadník
súčasťou svietidla je elektronicný predradník
w wyposażeniu lampy jest elektroniczny starterem
-  součástí svítidla je indukční předřadník se startérem
súčasťou svietidla je indukčný predradník so štartérom
w wyposażeniu lampy jest starter indukcyjny
-  lze použít standardní žárovku nebo kompaktní zářivku
je možné použiť štandardnú žiarovku alebo kompaktnú žiarivku
używać standardowej lub kompaktowej żarówki
-  počet žil v kabelu x jejich průřez
počet żył w kabli x ich przekrzes
ilość i przekrój w mm kabla
-  halogenových žárovek se nedotýkejte holými rukama
halogénových žiaroviek sa nedotýkajte holými rukami
halogenowych żarówek nie dotykać gołymi rękami
-  maximální úhel detekce pohybového čidla
maximálny uhol detekcie pohybového čidla
maksymalny przechył
-  Infracervený pohybový senzor
Infračervený pohybový senzor
Czujnik ruchu podczerwieni
-  Vysokofrekvenční pohybový senzor
Vysokofrekvenčný pohybový senzor
Czujnik ruchu mikrofalowy
-  objímka pro halogenovou žárovku GU10
objímka pre halogénovú žiarovku GU10
oprawka halogenowej żarówki G10
-  objímka pro halogenovou žárovku G9
objímka pre halogénovú žiarovku G9
oprawka halogenowej żarówki G9
-  objímka pro trubicovou halogenovou žárovku J
objímka pre trubicovú halogénovú žiarovku J
oprawka halogenowej żarówki J
-  objímka pro trubicovou metalhalogenidovou výbojku
objímka pre trubicovú metalhalogénovú výbojku
oprawka metalhalogenowej żarówki Rx7s
-  objímka pro nízkonapětovou žárovku T-15
objímka pre nízkonapätovú žiarovku T-15
oprawka niskonapiciowej żarówki T15
-  Index podání barev
Index podania farieb
Wskaźnik oddawania barw
-  Úhel rozptylu světla
Uhol rozptylu svetla
Kąt rozsytu światła
-  součástí je akumulátor
súčasťou je akumulátor
akumulator
-  součástí svítidla je stmívač; světelný zdroj lze stmívat
súčasťou svietidla je stmievač; svetelný zdroj je možné stmievat
w urządzeniu jest ściemniacz; lampa ze ściemniaczem
-  světelný zdroj není určen ke stmívání
svetelný zdroj nie je určený na stmievanie
lampę nie może pracować ze ściemniaczem
-  zapojení do zásuvky
zapojenie do zásuvky
włączący do gniazdka
-  určeno pro montáž na stěnu
určené pre montáž na stenu
przeznaczone do montazu na ścianie
-  určeno pro montáž na strop
určené pre montáž na strop
przeznaczone do montazu na suficie
-  určeno pro montáž na vodorovný pevný podklad
určené pre montáž na vodorovný pevný podklad
przeznaczone do montazu na równym podłożu

Stupeň krytí IP
Stupeň krytia IP
Stopień ochrony IP

- IP20** ochrana proti tělesům >12mm; bez ochrany proti vodě
 ochrana proti telesám >12mm; bez ochrany proti vode
 ochrona przed ciałami >12 mm; bez ochrony przed wodą
- IP23** ochrana proti tělesům >12mm; chráněno proti vodě dopadajícím pod úhlem max 60°
 ochrana proti telesám >12mm; chránené proti vode dopadajúcej pod uhlom max 60°
 ochrona przed ciałami > 12mm; chroni przed padającymi kroplami po kątem max.60
- IP33** ochrana proti tělesům >2,5mm; chráněno proti vodě dopadajícím pod úhlem max 60°
 ochrana proti telesám >2,5mm; chránené proti vode dopadajúcej pod uhlom max 60°
 ochrona przed ciałami >2,5 mm; chroni przed padającymi kroplami po kątem max.60
- IP43** ochrana proti tělesům >1mm; chráněno proti vodě dopadajícím pod úhlem max 60°
 ochrana proti telesám >1mm; chránené proti vode dopadajúcej pod uhlom max 60°
 ochrona przed ciałami > 1mm; chroni przed padającymi kroplami po kątem max.60
- IP44** ochrana proti tělesům >1mm; chráněno proti stříkající vodě
 ochrana proti telesám >1mm; chránené proti striekajúcej vode
 ochrona przed ciałami > 1mm; chroni przed padającymi kroplami pod dowolnym kątem wody
- IP54** ochrana před prachem; chráněno proti stříkající vodě
 ochrana pred prachom; chránené proti striekajúcej vode
 ochrona przed pyłem; chroni przed padającymi kroplami pod dowolnym kątem wody
- IP65** prachotěsné; chráněno proti tryskající vodě
 prachotesné; chránené proti tryskajúcej vode
 ochrona pyłoszczelna; chroni przed bryzgami
- IP68** prachotěsné; ochrana proti účinkům trvalého ponoření.
 prachotesné; ochrana proti účinkom trvalého ponorenia
 ochrona pyłoszczelna; chroni w zanurzeniu

Značky použitých materiálů
Značky použitých materiálův
Oznakowanie użytých materiałów

- | | | | |
|--|--|--|--|
|  plast
plast
tworzywo |  sklo
sklo
szkło |  dřevo
drevo
drewno |  umělý kámen
umělý kameň
imitacja kamienia |
|  kov
kov
metal |  keramika
keramika
ceramika |  proutí/bambus
prútie/bambus
bambus |  PS transparentní polystyren
transparentný polystyren
transparent polystyren |
|  hliník
hliník
aluminium |  látka
látka
tekstília |  papír
papier
papier |  ABS akrylonitrilbutadienstyren
akrylonitrilbutadienstyren
akrylonitrilbutadienstyren |

PC polykarbonát s výbornými optickými vlastnostmi, velmi dobrou pevností a zvýšenou tepelnou odolností
 polykarbonát s výbornými optickými vlastnosťami, veľmi dobrou pevnosťou a zvýšenou tepelnou odolnosťou
 polykarbonat z bardzo dobrymi optycznymi własnościami, ze zwiększoną odpornością na temperaturę

H05RR-F pryžový kabel; pro použití ve venkovním prostředí
 pryžový kábel; pre použitie vo vonkajšom prostredí
 gumowy przewód; używać w zewnętrznych pomieszczeniach

H05VV-F kabel s plastovou izolací; pro použití v suchém prostředí
 kábel s plastovou izoláciou; pre použitie v suchom prostredí
 przewód w izolacji z tworzywa; używać w suchych pomieszczeniach

UJIŠTĚNÍ O VYDÁNÍ ES PROHLÁŠENÍ O SHODĚ

Dovozce: Ecoplanet s.r.o.

Sídlo: Litoměřická 280/48
418 01 Bílina
Česká republika

IČ: 27278409

Potvrzujeme tímto, že pro námi distribuované výrobky, které jsou uvedeny na našich daňových dokladech, které jsou stanovenými výrobky dle zákona č. 22/1997 Sb., bylo vydáno ES prohlášení o shodě jejich vlastností s požadavky technických předpisů.

Námi dovážené výrobky odpovídají požadavkům těchto dokumentů:

Dokument č.	Název
2006/95/ES (LVD)	Směrnice Evropského parlamentu a Rady (ES) 2006/95/ES ze dne 12. prosince 2006 o harmonizaci právních předpisů členských států týkajících se elektrických zařízení určených pro používání v určitých mezích napětí (kodifikované znění).
2004/108/ES (EMC)	Směrnice Evropského parlamentu a Rady (ES) 2004/108/ES ze dne 15. prosince 2004 o sbližování právních předpisů členských států týkajících se elektromagnetické kompatibility a o zrušení směrnice 89/336/EHS.
2011/65/ES (ROHS)	Směrnice Evropského parlamentu a Rady (ES) 2011/65/ES ze dne 8. června 2011 o omezení používání některých nebezpečných látek v elektrických a elektronických zařízeních a v souladu s požadavky uvedeného nařízení vlády a požadavky uvedené směrnice jsou také dodávány na trh.

Místo vydání: Bílina

Datum vydání: 10.8.2015

Jméno: Ing. Lumír Füllsack

Funkce: jednatel

 **Ecoplanet** s.r.o.
Litoměřická 280/48, 418 01 Bílina
DIČ: CZ27278409 www.ecoplanet.cz

NOVÁ KORPORÁTNÍ IDENTITA



KATEGORIE PRODUKTŮ

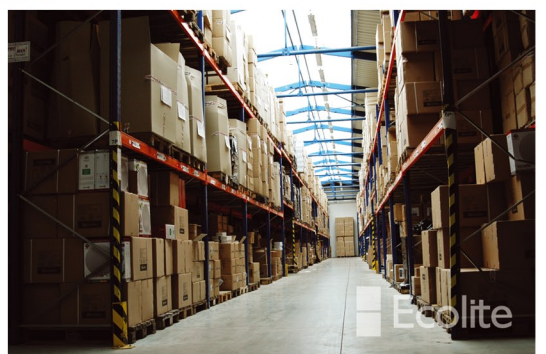
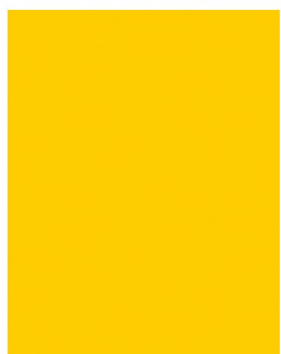

DIAGNOSTIKA+ VÝPOČTY OSVĚTLENÍ VAŠEHO PROJEKTU

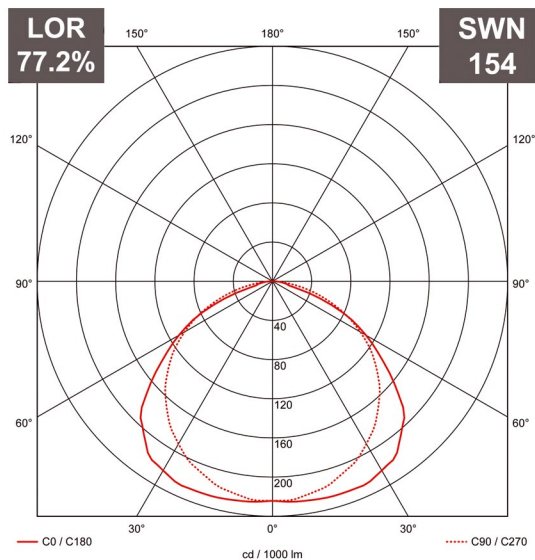

SVÍTIDLO, PŮLDORYS A POŽADAVKY

Zvolte si jedno z našich svítidel nebo si je nechte doporučit. Po odeslání specifikace místnosti a požadavku na **osvětlenost (lux)** vám pomocí fotometrických dat poskytneme výpočet osvětlení a vypracujeme kalkulaci na míru.

K výpočtům osvětlení používáme křivky svítivosti (.ldt nebo .ies), které poskytuje přímo výrobce. Výstup pro váš projekt vám zašleme ve **formátu PDF**.

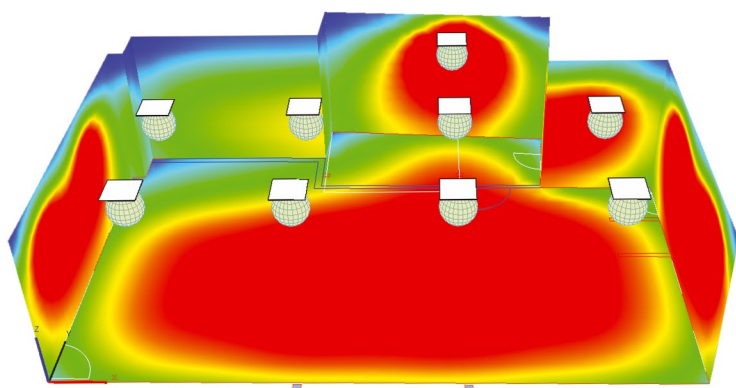
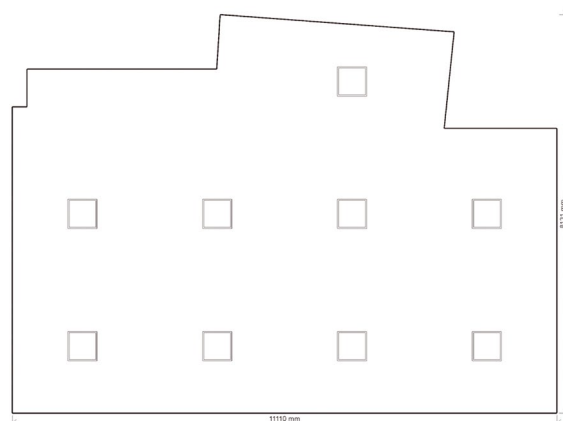

Součástí výpočtu je vizualizace osvětlení prostorů a doporučení na osvětlenost **dle platných norem ČSN**.

DIAGNOSTIKA

Ecoplanet disponuje vlastní laboratoří s kulovým integrátorem (fotometrická koule), kterým měříme účinnost a světelný tok produktů ve všech fázích výrobního a předprodejního procesu.



Ecoplanet s. r. o.
Litoměřická 280/48
418 01 Bílina

sklad:
Hrobčice č.p. 76
417 57 Hrobčice
tel./fax: 417 532 993
objednavky@ecoplanet.cz

