

TD

TL

TD

TL

H

D

H

d

bimed

 **ELTEQ**

OBSAH

Kabelové vývodky	3
Matice	13
Záslepky	15
Ochranné zátky pro vývodky	15
Mosazné kabelové vývodky pro stíněné kabely	16
Mosazné kabelové vývodky	20
Mosazné matice	23
Mosazné matice pro vývodky na stíněné kabely	25
Montážní vývodky	27

bimed

Kabelová vývodka s metrickým závitem

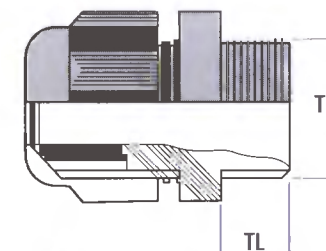

EN 50262

Technické parametry

Materiál:	Polyamid 6
Barva:	Ral 7001 (šedá) Ral 9005 (černá) Ral 7035 (světle šedá) Ral 3025 (červená) Ral 9003 (bílá) Ral 5015 (modrá)
Krytí:	IP 68, 5 barů
Pracovní teplota:	Stálá -30°C až 80°C Krátkodobá až do 150°C
Těsnění:	Neopren



Velikost	Označení šedé	Označení světle šedé	Označení černé	Označení modré	Označení bílé	Označení červené	TD [mm]	TL [mm]	W [mm]	Upínací rozsah [mm]
M 12	BM-05	BM-15	BM-25	BM-35	BM-45	BM-55	12	8	15	3,0 - 6,5
M 16	BM-01	BM-11	BM-21	BM-31	BM-41	BM-51	16	10	22	5,0 - 10,0
M 16	BM-01L	BM-11L	BM-21L	BM-31L	BM-41L	BM-51L	16	15	22	5,0 - 10,0
M 20	BM-02	BM-12	BM-22	BM-32	BM-42	BM-52	20	10	24	6,0 - 12,0
M 20	BM-02L	BM-12L	BM-22L	BM-32L	BM-42L	BM-52L	20	15	24	6,0 - 12,0
M 20	BM-03	BM-13	BM-23	BM-33	BM-43	BM-53	20	10	27	10,0 - 14,0
M 20	BM-04	BM-14	BM-24	BM-34	BM-44	BM-54	20	15	27	10,0 - 14,0
M 25	BM-05	BM-15	BM-25	BM-35	BM-45	BM-55	25	10	33	13,0 - 18,0
M 25	BM-06	BM-16	BM-26	BM-36	BM-46	BM-56	25	15	33	13,0 - 18,0
M 32	BM-07	BM-17	BM-27	BM-37	BM-47	BM-57	32	18	42	18,0 - 25,0
M 40	BM-08	BM-18	BM-28	BM-38	BM-48	BM-58	40	18	53	22,0 - 32,0
M 50	BM-09	BM-19	BM-29	BM-39	BM-49	BM-59	50	18	60	30,0 - 38,0
M 63	BM-10	BM-20	BM-30	BM-40	BM-50	BM-60	63	18	65	34,0 - 44,0

Vývodky s redukčním těsněním

Velikost	Označení šedé	Označení světle šedé	Označení černé	Označení modré	Označení bílé	Označení červené	TD [mm]	TL [mm]	W [mm]	Upínací rozsah [mm]
M 12	BI-05	BI-15	BI-25	BI-35	BI-45	BI-55	12	8	15	2,0 - 5,0
M 16	BI-01	BI-11	BI-21	BI-31	BI-41	BI-51	16	10	22	3,0 - 7,0
M 16	BI-01L	BI-11L	BI-21L	BI-31L	BI-41L	BI-51L	16	15	22	3,0 - 7,0
M 20	BI-02	BI-12	BI-22	BI-32	BI-42	BI-52	20	10	24	5,0 - 9,0
M 20	BI-02L	BI-12L	BI-22L	BI-32L	BI-42L	BI-52L	20	15	24	5,0 - 9,0
M 20	BI-03	BI-13	BI-23	BI-33	BI-43	BI-53	20	10	27	7,0 - 12,0
M 20	BI-04	BI-14	BI-24	BI-34	BI-44	BI-54	20	15	27	7,0 - 12,0
M 25	BI-05	BI-15	BI-25	BI-35	BI-45	BI-55	25	10	33	9,0 - 14,0
M 25	BI-06	BI-16	BI-26	BI-36	BI-46	BI-56	25	15	33	9,0 - 14,0
M 32	BI-07	BI-17	BI-27	BI-37	BI-47	BI-57	32	18	42	12,0 - 20,0
M 40	BI-08	BI-18	BI-28	BI-38	BI-48	BI-58	40	18	53	20,0 - 26,0
M 50	BI-09	BI-19	BI-29	BI-39	BI-49	BI-59	50	18	60	25,0 - 31,0
M 63	BI-10	BI-20	BI-30	BI-40	BI-50	BI-60	63	18	65	29,0 - 35,0

Kabelová vývodka s metrickým závitem

EN 50262

Technické parametry

Materiál:	Polyamid 6
Barva:	Ral 7001 (šedá) Ral 9005 (černá) Ral 7035 (světle šedá) Ral 3025 (červená) Ral 9003 (bílá) Ral 5015 (modrá)
Krytí:	IP 68, 5 barů
Pracovní teplota:	Stálá -30°C až 80°C Krátkodobá až do 150°C
Těsnění:	Neopren

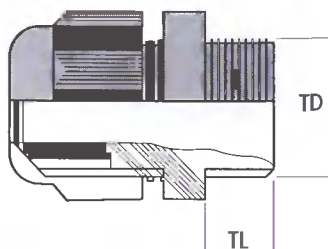

Velikost	Označení šedé	Označení světle šedé	Označení černé	Označení modré	Označení bílé	Označení červené	TD [mm]	TL [mm]	⌀ [mm]	Upínací rozsah [mm]
M 12	BM-EN-05	BM-EN-15	BM-EN-25	BM-EN-35	BM-EN-45	BM-EN-55	12	6	15	3,0 - 7,0
M 16	BM-EN-01	BM-EN-11	BM-EN-21	BM-EN-31	BM-EN-41	BM-EN-51	16	6	19	4,0 - 8,0
M 20	BM-EN-02	BM-EN-12	BM-EN-22	BM-EN-32	BM-EN-42	BM-EN-52	20	8	24	6,0 - 12,0
M 25	BM-EN-03	BM-EN-13	BM-EN-23	BM-EN-33	BM-EN-43	BM-EN-53	25	8	29	11,0 - 17,0
M 32	BM-EN-04	BM-EN-14	BM-EN-24	BM-EN-34	BM-EN-44	BM-EN-54	32	10	36	15,0 - 21,0
M 40	BM-EN-05	BM-EN-15	BM-EN-25	BM-EN-35	BM-EN-45	BM-EN-55	40	10	46	19,0 - 28,0
M 50	BM-EN-06	BM-EN-16	BM-EN-26	BM-EN-36	BM-EN-46	BM-EN-56	50	12	60	26,0 - 37,0
M 63	BM-EN-07	BM-EN-17	BM-EN-27	BM-EN-37	BM-EN-47	BM-EN-57	63	12	65	34,0 - 44,0

Kabelová vývodka s Pg závitem

VDE 0619

Technické parametry

Materiál:	Polyamid 6
Barva:	Ral 7001 (šedá) Ral 9005 (černá) Ral 7035 (světle šedá) Ral 3025 (červená) Ral 9003 (bílá) Ral 5015 (modrá)
Krytí:	IP 68, 5 barů
Pracovní teplota:	Stálá -30°C až 80°C Krátkodobá až do 150°C
Těsnění:	Neopren

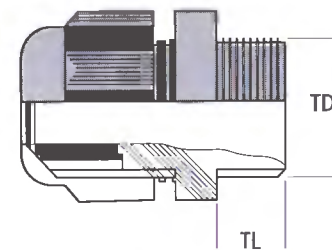

Velikost	Označení šedé	Označení světle šedé	Označení černé	Označení modré	Označení bílé	Označení červené	TD [mm]	TL [mm]	⌀ [mm]	Upínací rozsah [mm]
Pg 7	BS-01	BS-11	BS-21	BS-31	BS-41	BS-51	13	8	15	3,0 - 6,5
Pg 9	BS-02	BS-12	BS-22	BS-32	BS-42	BS-52	16	8	19	4,0 - 8,0
Pg 11	BS-03	BS-13	BS-23	BS-33	BS-43	BS-53	19	8	22	5,0 - 10,0
Pg 13,5	BS-04	BS-14	BS-24	BS-34	BS-44	BS-54	21	9	27	6,0 - 12,0
Pg 16	BS-05	BS-15	BS-25	BS-35	BS-45	BS-55	23	10	27	10,0 - 14,0
Pg 21	BS-06	BS-16	BS-26	BS-36	BS-46	BS-56	29	11	33	13,0 - 18,0
Pg 29	BS-07	BS-17	BS-27	BS-37	BS-47	BS-57	37	11	42	18,0 - 25,0
Pg 36	BS-08	BS-18	BS-28	BS-38	BS-48	BS-58	47	13	53	22,0 - 32,0
Pg 42	BS-09	BS-19	BS-29	BS-39	BS-49	BS-59	54	13	60	30,0 - 38,0
Pg 48	BS-10	BS-20	BS-30	BS-40	BS-50	BS-60	59	14	65	34,0 - 44,0

Vývodky s redukčním těsněním

Velikost	Označení šedé	Označení světle šedé	Označení černé	Označení modré	Označení bílé	Označení červené	TD [mm]	TL [mm]	⌀ [mm]	Upínací rozsah [mm]
Pg 7	BSR-01	BSR-11	BSR-21	BSR-31	BSR-41	BSR-51	13	8	15	2,0 - 5,0
Pg 9	BSR-02	BSR-12	BSR-22	BSR-32	BSR-42	BSR-52	16	8	19	2,0 - 6,0
Pg 11	BSR-03	BSR-13	BSR-23	BSR-33	BSR-43	BSR-53	19	8	22	3,0 - 7,0
Pg 13,5	BSR-04	BSR-14	BSR-24	BSR-34	BSR-44	BSR-54	21	9	27	5,0 - 9,0
Pg 16	BSR-05	BSR-15	BSR-25	BSR-35	BSR-45	BSR-55	23	10	27	7,0 - 12,0
Pg 21	BSR-06	BSR-16	BSR-26	BSR-36	BSR-46	BSR-56	29	11	33	9,0 - 16,0
Pg 29	BSR-07	BSR-17	BSR-27	BSR-37	BSR-47	BSR-57	37	11	42	12,0 - 20,0
Pg 36	BSR-08	BSR-18	BSR-28	BSR-38	BSR-48	BSR-58	47	13	53	20,0 - 26,0
Pg 42	BSR-09	BSR-19	BSR-29	BSR-39	BSR-49	BSR-59	54	13	60	25,0 - 31,0
Pg 48	BSR-10	BSR-20	BSR-30	BSR-40	BSR-50	BSR-60	59	14	65	29,0 - 35,0

Kabelové vývodky s NPT závitem

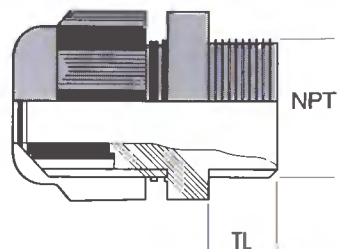

Technické parametry

Materiál:	Polyamid 6
Barva:	Ral 7001 (šedá) Ral 9005 (černá) Ral 7035 (světle šedá)
Krytí:	IP 68, 5 barů
Pracovní teplota:	Stálá -30°C až 80°C Krátkodobá až do 150°C
Těsnění:	Neopren



Velikost	Označení šedé	Označení světle šedé	Označení černé	TL [palce]	C [palce]	Upínací rozsah [palce]
NPT 3/8	BSPA-01	BSPA-11	BSPA-21	0,590	0,866	0,394 - 0,197
NPT 3/8	BSPB-01	BSPB-11	BSPB-21	0,590	0,945	0,472 - 0,236
NPT 1/2	BSPB-02	BSPB-12	BSPB-22	0,590	0,945	0,472 - 0,236
NPT 1/2	BSPBA-02	BSPBA-12	BSPBA-22	0,590	0,866	0,394 - 0,197
NPT 1/2	BSPC-02	BSPC-12	BSPC-22	0,590	1,063	0,551 - 0,394
NPT 1/2	BSPCA-02	BSPCA-12	BSPCA-22	0,590	1,299	0,709 - 0,511
NPT 3/4	BSPC-03	BSPC-13	BSPC-23	0,590	1,063	0,551 - 0,394
NPT 3/4	BSPD-03	BSPD-13	BSPD-23	0,590	1,299	0,709 - 0,511
NPT 1	BSP-04	BSP-14	BSP-24	0,709	1,654	0,984 - 0,709
NPT 1 1/4	BSPE-05	BSPE-15	BSPE-25	0,709	2,087	1,866 - 1,260

Vývodky s redukčním těsněním

NPT 3/8	BSPA-01R	BSPA-11R	BSPA-21R	0,590	0,866	0,276 - 0,118
NPT 3/8	BSPB-01R	BSPB-11R	BSPB-21R	0,590	0,945	0,354 - 0,197
NPT 1/2	BSPB-02R	BSPB-12R	BSPB-22R	0,590	0,945	0,354 - 0,197
NPT 1/2	BSPBA-02R	BSPBA-12R	BSPBA-22R	0,590	0,866	0,276 - 0,118
NPT 1/2	BSPC-02R	BSPC-12R	BSPC-22R	0,590	1,063	0,472 - 0,276
NPT 1/2	BSPCA-02R	BSPCA-12R	BSPCA-22R	0,590	1,299	0,630 - 0,354
NPT 3/4	BSPC-03R	BSPC-13R	BSPC-23R	0,590	1,063	0,472 - 0,276
NPT 3/4	BSPD-03R	BSPD-13R	BSPD-23R	0,590	1,299	0,630 - 0,354
NPT 1	BSP-04R	BSP-14R	BSP-24R	0,709	1,654	0,787 - 0,472
NPT 1 1/4	BSPE-05R	BSPE-15R	BSPE-25R	0,709	2,087	1,787 - 1,024

Kabelové vývodky s PF závitem

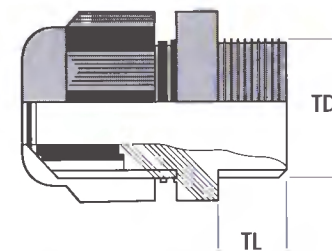

Technické parametry

Materiál:	Polyamid 6
Barva:	Ral 7001 (šedá) Ral 9005 (černá) Ral 7035 (světle šedá)
Krytí:	IP 68, 5 barů
Pracovní teplota:	Stálá -30°C až 80°C Krátkodobá až do 150°C
Těsnění:	Neopren



Velikost	Označení šedé	Označení světle šedé	Označení černé	TD [mm]	TL [mm]	C [mm]	Upínací rozsah [mm]
PF 3/8	BPF-01	BPF-11	BPF-21	17	11	22	5,0 - 10,0
PF 1/2	BPF-02	BPF-12	BPF-22	21	11	24	6,0 - 12,0
PF 1/2	BPF-03	BPF-13	BPF-23	21	11	27	10,0 - 14,0
PF 3/4	BPF-04	BPF-14	BPF-24	27	12	33	13,0 - 18,0
PF 1	BPF-05	BPF-15	BPF-25	33	13	42	18,0 - 25,0

Vývodky s redukčním těsněním

PF 3/8	BPFR-01	BPFR-11	BPFR-21	17	11	22	3,0 - 7,0
PF 1/2	BPFR-02	BPFR-12	BPFR-22	21	11	24	5,0 - 9,0
PF 1/2	BPFR-03	BPFR-13	BPFR-23	21	11	27	7,0 - 12,0
PF 3/4	BPFR-04	BPFR-14	BPFR-24	27	12	33	9,0 - 16,0
PF 1	BPFR-05	BPFR-15	BPFR-25	33	13	42	12,0 - 20,0

Kabelová vývodka s Pg závitem

DIN 46320

Technické parametry

Materiál:	Polyamid 6
Barva:	Ral 7001 (šedá) Ral 9005 (černá) Ral 7035 (světle šedá)
Krytí:	IP 54
Pracovní teplota:	Stálá -30°C až 80°C
Těsnění:	PVC

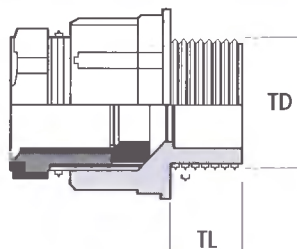

Velikost	Označení šedé	Označení světle šedé	Označení černé	TD [mm]	TL [mm]	⌀ [mm]	Upínací rozsah [mm]
Pg 7	BD-01	BD-11	BD-21	13	8	15	3,0 - 6,0
Pg 9	BD-02	BD-12	BD-22	16	8	19	4,5 - 7,0
Pg 11	BD-03	BD-13	BD-23	19	8	22	6,0 - 9,0
Pg 13,5	BD-04	BD-14	BD-24	21	9	24	9,0 - 12,0
Pg 16	BD-05	BD-15	BD-25	23	10	27	11,0 - 14,0
Pg 21	BD-06	BD-16	BD-26	29	11	33	14,0 - 18,0
Pg 29	BD-07	BD-17	BD-27	37	11	42	18,0 - 25,0
Pg 36	BD-08	BD-18	BD-28	47	13	53	25,0 - 32,0

Spirálová kabelová vývodka s metrickým závitem

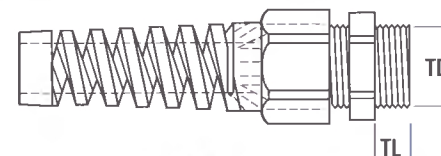

Technické parametry

Materiál:	Polyamid 6
Barva:	Ral 7001 (šedá) Ral 9005 (černá) Ral 7035 (světle šedá)
Krytí:	IP 68, 5 barů
Pracovní teplota:	Stálá -30°C až 80°C Krátkodobá až do 150°C
Těsnění:	Neopren



Velikost	Označení šedé	Označení světle šedé	Označení černé	TD [mm]	TL [mm]	⌀ [mm]	Upínací rozsah [mm]
M 12	BMSP-05	BMSP-15	BMSP-25	12	8	15	3,0 - 6,5
M 16	BMSP-01	BMSP-11	BMSP-21	16	10	22	5,0 - 10,0
M 16	BMSP-01L	BMSP-11L	BMSP-21L	16	15	22	5,0 - 10,0
M 20	BMSP-02	BMSP-12	BMSP-22	20	10	24	6,0 - 12,0
M 20	BMSP-02L	BMSP-12L	BMSP-22L	20	15	24	6,0 - 12,0
M 20	BMSP-03	BMSP-13	BMSP-23	20	10	27	10,0 - 14,0
M 20	BMSP-04	BMSP-14	BMSP-24	20	15	27	10,0 - 14,0
M 25	BMSP-05	BMSP-15	BMSP-25	25	10	33	13,0 - 18,0
M 25	BMSP-06	BMSP-16	BMSP-26	25	15	33	13,0 - 18,0

Vývodky s redukčním těsněním

Velikost	Označení šedé	Označení světle šedé	Označení černé	TD [mm]	TL [mm]	⌀ [mm]	Upínací rozsah [mm]
M 12	BISP-05	BISP-15	BISP-25	12	8	15	2,0 - 5,0
M 16	BISP-01	BISP-11	BISP-21	16	10	22	3,0 - 7,0
M 16	BISP-01L	BISP-11L	BISP-21L	16	15	22	3,0 - 7,0
M 20	BISP-02	BISP-12	BISP-22	20	10	24	5,0 - 9,0
M 20	BISP-02L	BISP-12L	BISP-22L	20	15	24	5,0 - 9,0
M 20	BISP-03	BISP-13	BISP-23	20	10	27	7,0 - 12,0
M 20	BISP-04	BISP-14	BISP-24	20	15	27	7,0 - 12,0
M 25	BISP-05	BISP-15	BISP-25	25	10	33	9,0 - 14,0
M 25	BISP-06	BISP-16	BISP-26	25	15	33	9,0 - 14,0

Spirálová kabelová vývodka s Pg závitem

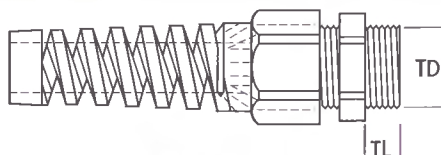

Technické parametry

Materiál:	Polyamid 6
Barva:	Ral 7001 (šedá) Ral 9005 (černá) Ral 7035 (světle šedá)
Krytí:	IP 68, 5 barů
Pracovní teplota:	Stálá -30°C až 80°C Krátkodobá až do 150°C
Těsnění:	Neopren



Velikost	Označení šedé	Označení světle šedé	Označení černé	TD [mm]	TL [mm]	⌀ [mm]	Upínací rozsah [mm]
Pg 7	BSSP-01	BSSP-11	BSSP-21	13	8	15	3,0 - 6,5
Pg 9	BSSP-02	BSSP-12	BSSP-22	16	8	19	4,0 - 8,0
Pg 11	BSSP-03	BSSP-13	BSSP-23	19	8	22	5,0 - 10,0
Pg 13,5	BSSP-04	BSSP-14	BSSP-24	21	9	24	6,0 - 12,0
Pg 16	BSSP-05	BSSP-15	BSSP-25	23	10	27	10,0 - 14,0
Pg 21	BSSP-06	BSSP-16	BSSP-26	29	11	33	13,0 - 18,0

Vývodky s redukčním těsněním

Velikost	Označení šedé	Označení světle šedé	Označení černé	TD [mm]	TL [mm]	⌀ [mm]	Upínací rozsah [mm]
Pg 7	BSRP-01	BSRP-11	BSRP-21	13	8	15	2,0 - 5,0
Pg 9	BSRP-02	BSRP-12	BSRP-22	16	8	19	2,0 - 6,0
Pg 11	BSRP-03	BSRP-13	BSRP-23	19	8	22	3,0 - 7,0
Pg 13,5	BSRP-04	BSRP-14	BSRP-24	21	9	24	5,0 - 9,0
Pg 16	BSRP-05	BSRP-15	BSRP-25	23	10	27	7,0 - 12,0
Pg 21	BSRP-06	BSRP-16	BSRP-26	29	11	33	9,0 - 16,0

Spirálová kabelová vývodka s NPT závitem

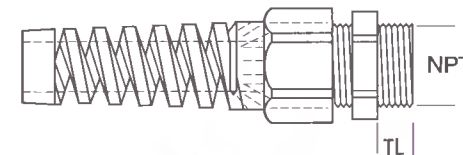

Technické parametry

Materiál:	Polyamid 6
Barva:	Ral 7001 (šedá) Ral 9005 (černá) Ral 7035 (světle šedá)
Krytí:	IP 68, 5 barů
Pracovní teplota:	Stálá -30°C až 80°C Krátkodobá až do 150°C
Těsnění:	Neopren



Velikost	Označení šedé	Označení světle šedé	Označení černé	TL [inch]	⌀ [inch]	Upínací rozsah [inch]
NPT 3/8	BNSPA-01	BNSPA-11	BNSPA-21	0,590	0,866	0,394 - 0,197
NPT 3/8	BNSPB-01	BNSPB-11	BNSPB-21	0,590	0,945	0,472 - 0,236
NPT 1/2	BNSPB-02	BNSPB-12	BNSPB-22	0,590	0,945	0,472 - 0,236
NPT 1/2	BNSPBA-02	BNSPBA-12	BNSPBA-22	0,590	0,866	0,394 - 0,197
NPT 1/2	BNSPC-02	BNSPC-12	BNSPC-22	0,590	1,063	0,551 - 0,394
NPT 1/2	BNSPCA-02	BNSPCA-12	BNSPCA-22	0,590	1,299	0,709 - 0,511
NPT 3/4	BNSPC-03	BNSPC-13	BNSPC-23	0,590	1,063	0,551 - 0,394
NPT 3/4	BNSPD-03	BNSPD-13	BNSPD-23	0,590	1,299	0,709 - 0,511
NPT 1	BNSP-04	BNSP-14	BNSP-24	0,709	1,654	0,984 - 0,709
NPT 1 1/4	BNSPE-05	BNSPE-15	BNSPE-25	0,709	2,087	1,866 - 1,260

Vývodky s redukčním těsněním

Velikost	Označení šedé	Označení světle šedé	Označení černé	TL [inch]	⌀ [inch]	Upínací rozsah [inch]
NPT 3/8	BNSPA-01R	BNSPA-11	BNSPA-21	0,590	0,866	0,276 - 0,118
NPT 3/8	BNSPB-01R	BNSPB-11	BNSPB-21	0,590	0,945	0,354 - 0,197
NPT 1/2	BNSPB-02R	BNSPB-12	BNSPB-22	0,590	0,945	0,354 - 0,197
NPT 1/2	BNSPBA-02R	BNSPBA-12	BNSPBA-22	0,590	0,866	0,276 - 0,118
NPT 1/2	BNSPC-02R	BNSPC-12	BNSPC-22	0,590	1,063	0,472 - 0,276
NPT 1/2	BNSPCA-02R	BNSPCA-12	BNSPCA-22	0,590	1,299	0,630 - 0,354
NPT 3/4	BNSPC-03R	BNSPC-13	BNSPC-23	0,590	1,063	0,472 - 0,276
NPT 3/4	BNSPD-03R	BNSPD-13	BNSPD-23	0,590	1,299	0,630 - 0,354
NPT 1	BNSP-04R	BNSP-14	BNSP-24	0,709	1,654	0,787 - 0,472
NPT 1 1/4	BNSPE-05R	BNSPE-15	BNSPE-25	0,709	2,087	1,787 - 1,024

Spirálové kabelové vývodky s PF závitem

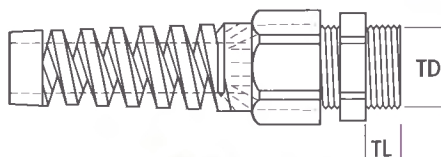

Technické parametry

Materiál:	Polyamid 6
Barva:	Ral 7001 (šedá) Ral 9005 (černá) Ral 7035 (světle šedá)
Krytí:	IP 68, 5 barů
Pracovní teplota:	Stálá -30°C až 80°C Krátkodobá až do 150°C
Těsnění:	Neopren

Velikost	Označení šedé	Označení světle šedé	Označení černé	TD [mm]	TL [mm]	⌀C [mm]	Upínací rozsah [mm]
PF 3/8	BFSP-01	BFSP-11	BFSP-21	17	11	22	5,0 - 10,0
PF 1/2	BFSP-02	BFSP-12	BFSP-22	21	11	24	6,0 - 12,0
PF 1/2	BFSP-03	BFSP-13	BFSP-23	21	11	27	10,0 - 14,0
PF 3/4	BFSP-04	BFSP-14	BFSP-24	27	12	33	13,0 - 18,0
PF 1	BFSP-05	BFSP-15	BFSP-25	33	13	42	18,0 - 25,0

Vývodky s redukčním těsněním

PF 3/8	BFSR-01	BFSR-11	BFSR-21	17	11	22	3,0 - 7,0
PF 1/2	BFSR-02	BFSR-12	BFSR-22	21	11	24	5,0 - 9,0
PF 1/2	BFSR-03	BFSR-13	BFSR-23	21	11	27	7,0 - 12,0
PF 3/4	BFSR-04	BFSR-14	BFSR-24	27	12	33	9,0 - 16,0
PF 1	BFSR-05	BFSR-15	BFSR-25	33	13	42	12,0 - 20,0

Matice s metrickým, NPT a PF závitem

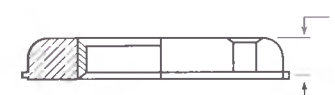

Technické parametry

Materiál:	Polyamid 6, 30% skelného vlákna
Barva:	Ral 7001 (šedá) Ral 9005 (černá) Ral 7035 (světle šedá) Ral 3025 (červená) Ral 9003 (bílá) Ral 5015 (modrá)



Velikost	Označení šedé	Označení světle šedé	Označení černé	Označení modré	Označení bílé	Označení červené	H [mm]	⌀C [mm]
M 12	BML-05	BML-15	BML-25	BML-35	BML-45	BML-55	5	18
M 16	BML-01	BML-11	BML-21	BML-31	BML-41	BML-51	5	22
M 20	BML-02	BML-12	BML-22	BML-32	BML-42	BML-52	6	26
M 25	BML-03	BML-13	BML-23	BML-33	BML-43	BML-53	6	32
M 32	BML-04	BML-14	BML-24	BML-34	BML-44	BML-54	7	41
M 40	BML-05	BML-15	BML-25	BML-35	BML-45	BML-55	7	50
M 50	BML-06	BML-16	BML-26	BML-36	BML-46	BML-56	8	60
M 63	BML-07	BML-17	BML-27	BML-37	BML-47	BML-57	8	75

NPT 3/8	BPL-01	BPL-11	BPL-21	-	-	-	5	22
NPT 1/2	BPL-02	BPL-12	BPL-22	-	-	-	5	27
NPT 3/4	BPL-03	BPL-13	BPL-23	-	-	-	5	33
NPT 1	BPL-04	BPL-14	BPL-24	-	-	-	6	47

PF 3/8	BFL-01	BFL-11	BFL-21	-	-	-	5	22
PF 1/2	BFL-02	BFL-12	BFL-22	-	-	-	5	27
PF 3/4	BFL-03	BFL-13	BFL-23	-	-	-	5	33
PF 1	BFL-04	BFL-14	BFL-24	-	-	-	6	47

Matice s Pg závitem

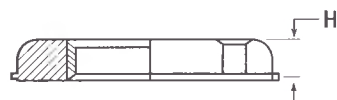

DIN 46320

Technické parametry

Materiál: Polyamid 6, 30% skelného vlákna
Barva: Ral 7001 (šedá)
 Ral 9005 (černá)
 Ral 7035 (světle šedá)



Velikost	Označení šedé	Označení světle šedé	Označení černé	H [mm]	C [mm]
Pg 7	BL-01	BL-11	BL-21	5	19
Pg 9	BL-02	BL-12	BL-22	5	22
Pg 11	BL-03	BL-13	BL-23	5	24
Pg 13,5	BL-04	BL-14	BL-24	6	27
Pg 16	BL-05	BL-15	BL-25	6	30
Pg 21	BL-06	BL-16	BL-26	7	36
Pg 29	BL-07	BL-17	BL-27	7	46
Pg 36	BL-08	BL-18	BL-28	8	60
Pg 42	BL-09	BL-19	BL-29	8	65
Pg 48	BL-10	BL-20	BL-30	8	70

Záslepky s Pg a metrickým závitem

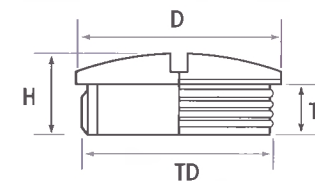

DIN 4320

Technické parametry

Materiál: Polyamid 6
Barva: Ral 7001 (šedá)
 Ral 9005 (černá)
 Ral 7035 (světle šedá)



Velikost	Označení šedé	Označení světle šedé	Označení černé	H [mm]	D [mm]
Pg 7	BBS-01	BBS-11	BBS-21	8	15
Pg 9	BBS-02	BBS-12	BBS-22	9	19
Pg 11	BBS-03	BBS-13	BBS-23	9	22
Pg 13,5	BBS-04	BBS-14	BBS-24	9,5	25
Pg 16	BBS-05	BBS-15	BBS-25	9,5	27
Pg 21	BBS-06	BBS-16	BBS-26	11	33
Pg 29	BBS-07	BBS-17	BBS-27	12	44
Pg 36	BBS-08	BBS-18	BBS-28	15	55

M 12	BMBS-05	BMBS-15	BMBS-25	6	15
M 16	BMBS-01	BMBS-11	BMBS-21	6	20
M 20	BMBS-02	BMBS-12	BMBS-22	6	24
M 25	BMBS-03	BMBS-13	BMBS-23	8	30
M 32	BMBS-04	BMBS-14	BMBS-24	8	37
M 40	BMBS-05	BMBS-15	BMBS-25	8	46
M 50	BMBS-06	BMBS-16	BMBS-26	10	56
M 63	BMBS-07	BMBS-17	BMBS-27	12	70

Ochranné zátky pro vývodky s Pg a metrickým závitem

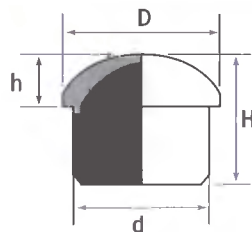

Technické parametry

Materiál: Polyamid 6
Barva: Ral 7001 (šedá)
 Ral 9005 (černá)
 Ral 7035 (světle šedá)



Velikost	Označení šedé	Označení světle šedé	Označení černé	h [mm]	H [mm]	d [mm]	D [mm]
Pg 11	BPT-01	BPT-11	BPT-21	5,5	14,5	9,8	13,5
Pg 13,5	BPT-02	BPT-12	BPT-22	8	14,5	11,8	16
Pg 16	BPT-03	BPT-13	BPT-23	9,5	19,5	13,6	18,5
Pg 21	BPT-04	BPT-14	BPT-24	10,1	21,5	17,8	22
Pg 29	BPT-05	BPT-15	BPT-25	10,2	25	25	28,5
Pg 36	BPT-06	BPT-16	BPT-26	11,2	27,7	31,8	37,5
M 16	BPT-01	BPT-11	BPT-21	5,5	14,5	9,8	13,5
M 20	BPT-02	BPT-12	BPT-22	8	14,5	11,8	16
M 25	BPT-04	BPT-14	BPT-24	10,1	21,5	17,8	22
M 32	BPT-05	BPT-15	BPT-25	10,2	25	25	28,5
M 40	BPT-06	BPT-16	BPT-26	11,2	27,7	31,8	37,5

Mosazná kabelová vývodka pro stíněné kabely s metrickým závitem

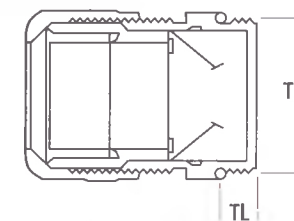

Technické parametry

Materiál: Poniklovaná mosaz
Vložka: Polyamid 6
Krytí: IP 68
Pracovní teplota: Stálá -40°C až 100°C
Těsnění: Neopren
„O“ kroužek: NBR



Velikost	Označení	TD [mm]	TL [mm]	Min. Shield [mm]	⌀ [mm]	Upínací rozsah [mm]
M 12	BMEM-05	12	6,5	2,5	14 - 14	4,0 - 8,0
M 16	BMEM-01	16	7	3	18 - 17	5,0 - 10,0
M 20	BMEM-02	20	8	5	22 - 22	6,0 - 12,0
M 25	BMEM-03	25	8	8	27 - 24	10,0 - 14,0
M 32	BMEM-04	32	9	11	34 - 30	13,0 - 18,0
M 40	BMEM-05	40	9	16	43 - 40	18,0 - 25,0
M 50	BMEM-06	50	10	19	55 - 50	22,0 - 32,0
M 63	BMEM-07	63	15	30	68 - 64	34,0 - 44,0

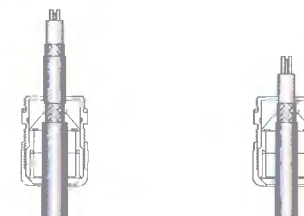

Vývodky s prodlouženým závitem

M 12	BMEN-05	12	12	2,5	14 - 14	4,0 - 8,0
M 16	BMEN-01	16	12	3	18 - 17	5,0 - 10,0
M 20	BMEN-02	20	12	5	22 - 22	6,0 - 12,0
M 25	BMEN-03	25	12	8	27 - 24	10,0 - 14,0
M 32	BMEN-04	32	15	11	34 - 30	13,0 - 18,0
M 40	BMEN-05	40	15	16	43 - 40	18,0 - 25,0
M 50	BMEN-06	50	15	19	55 - 50	22,0 - 32,0
M 63	BMEN-07	63	18	30	68 - 64	34,0 - 44,0

Mosazná kabelová vývodka pro stíněné kabely s Pg závitem

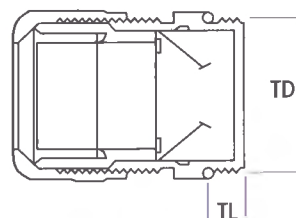

Technické parametry

Materiál:	Poniklovaná mosaz
Vložka:	Polyamid 6
Krytí:	IP 68
Pracovní teplota:	Stálá -40°C až 100°C
Těsnění:	Neopren
„O“ kroužek:	NBR



Velikost	Označení	TD [mm]	TL [mm]	Min. Shield [mm]	C [mm]	Upínací rozsah [mm]
Pg 7	BSEM-01	13	6	2,5	14	3,0 - 6,5
Pg 9	BSEM-02	16	6	3	17	4,0 - 8,0
Pg 11	BSEM-03	19	6	4	20	5,0 - 10,0
Pg 13,5	BSEM-04	21	6,5	5	22	6,0 - 12,0
Pg 16	BSEM-05	23	6,5	8	24	10,0 - 14,0
Pg 21	BSEM-06	29	7,5	11	30	13,0 - 18,0
Pg 29	BSEM-07	37	7,5	16	40	18,0 - 25,0
Pg 36	BSEM-08	47	10	19	50	22,0 - 32,0
Pg 42	BSEM-09	54	12	27	58	30,0 - 38,0
Pg 48	BSEM-10	59	14	30	64	34,0 - 44,0

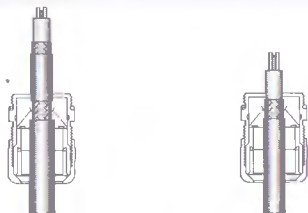

Vývodky s prodlouženým závitem

Pg 7	BSEN-01	10	8	2,5	14	3,0 - 6,5
Pg 9	BSEN-02	16	10	3	17	4,0 - 8,0
Pg 11	BSEN-03	19	10	4	20	5,0 - 10,0
Pg 13,5	BSEN-04	21	10	5	22	6,0 - 12,0
Pg 16	BSEN-05	23	10	8	24	10,0 - 14,0
Pg 21	BSEN-06	29	12	11	30	13,0 - 18,0
Pg 29	BSEN-07	37	12	16	40	18,0 - 25,0

Mosazná kabelová vývodka pro stíněné kabely s NPT závitem

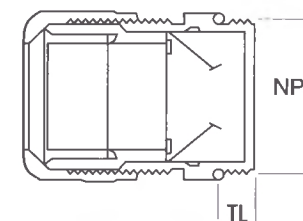

Technické parametry

Materiál:	Poniklovaná mosaz
Vložka:	Polyamid 6
Krytí:	IP 68
Pracovní teplota:	Stálá -40°C až 100°C
Těsnění:	Neopren
„O“ kroužek:	NBR



Velikost	Označení	TD [mm]	TL [mm]	C [mm]	Upínací rozsah [mm]
NPT 3/8	BNEM-01	16	15	17	4,0 - 8,0
NPT 1/2	BNEM-02	21	13	22	6,0 - 12,0
NPT 3/4	BNEM-03	29	13	30	13,0 - 16,0

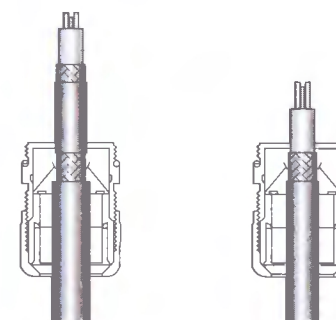

Mosazná kabelová vývodka s metrickým závitem

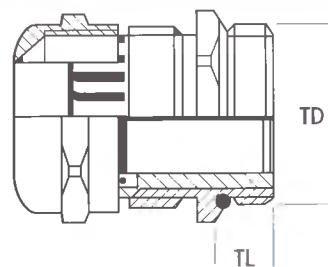

Technické parametry

Materiál:	Poniklovaná mnsaz
Vložka:	Polyamid 6
Krytí:	IP 68
Pracovní teplota:	Stálá -40°C až 100°C
Těsnění:	Neopren
„O“ kroužek:	NBR



Velikost	Označení	TD [mm]	TL [mm]	⌀ [mm]	Upínací rozsah [mm]
M 12	BMBC-05	12	6,5	14 - 14	3,0 - 6,5
M 16	BMBC-01	16	7	18 - 17	4,0 - 8,0
M 20	BMBC-02	20	8	22 - 22	6,0 - 12,0
M 25	BMBC-03	25	8	27 - 24	10,0 - 14,0
M 32	BMBC-04	32	9	34 - 30	13,0 - 18,0
M 40	BMBC-05	40	9	43 - 40	18,0 - 25,0
M 50	BMBC-06	50	10	55 - 50	22,0 - 32,0
M 63	BMBC-07	63	15	68 - 64	34,0 - 44,0

Vývodky s prodlouženým závitem

M 12	BMBE-05	12	12	14 - 14	3,0 - 6,5
M 16	BMBE-01	16	12	18 - 17	4,0 - 8,0
M 20	BMBE-02	20	12	22 - 22	6,0 - 12,0
M 25	BMBE-03	25	12	27 - 24	10,0 - 14,0
M 32	BMBE-04	32	15	34 - 30	13,0 - 18,0
M 40	BMBE-05	20	15	43 - 40	18,0 - 25,0
M 50	BMBE-06	25	15	55 - 50	22,0 - 32,0
M 63	BMBE-07	32	18	68 - 64	34,0 - 44,0

Mosazná kabelová vývodka s Pg závitem

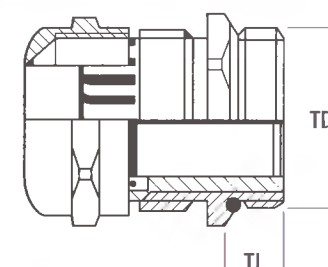

Technické parametry

Materiál:	Poniklovaná mosaz
Vložka:	Polyamid 6
Krytí:	IP 68
Pracovní teplota:	Stálá -40°C až 100°C
Těsnění:	Neopren
„O“ kroužek:	NBR



Velikost	Označení	TD [mm]	TL [mm]	⌀ [mm]	Upínací rozsah [mm]
Pg 7	BSBC-01	13	6	14	3,0 - 6,5
Pg 9	BSBC-02	16	6	17	4,0 - 8,0
Pg 11	BSBC-03	19	6	20	5,0 - 10,0
Pg 13,5	BSBC-04	21	6,5	22	6,0 - 12,0
Pg 16	BSBC-05	23	6,5	24	10,0 - 14,0
Pg 21	BSBC-06	29	7	30	13,0 - 18,0
Pg 29	BSBC-07	37	8	40	18,0 - 25,0
Pg 36	BSBC-08	47	10	50	22,0 - 32,0
Pg 42	BSBC-09	54	12	58	30,0 - 38,0
Pg 48	BSBC-10	59	14	64	34,0 - 44,0

Vývodky s prodlouženým závitem

Pg 7	BSBE-01	13	10	14	3,0 - 6,5
Pg 9	BSBE-02	16	10	17	4,0 - 8,0
Pg 11	BSBE-03	19	10	20	5,0 - 10,0
Pg 13,5	BSBE-04	21	10	22	6,0 - 12,0
Pg 16	BSBE-05	23	10	24	10,0 - 14,0
Pg 21	BSBE-06	29	12	30	13,0 - 18,0
Pg 29	BSBE-07	37	12	40	18,0 - 25,0
Pg 36	BSBE-08	47	14	50	22,0 - 32,0
Pg 42	BSBE-09	54	16	58	30,0 - 38,0
Pg 48	BSBE-10	59	18	64	34,0 - 44,0

Mosazná kabelová vývodka s NPT závitem

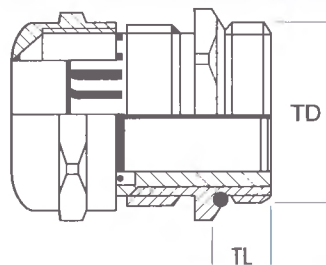

Technické parametry

Materiál:	Poniklovaná mosaz
Vložka:	Polyamid 6
Krytí:	IP 68
Pracovní teplota:	Stálá -40°C až 100°C
Těsnění:	Neopren
„O“ kroužek:	NBR



Velikost	Označení	TD [mm]	TL [mm]	⌀ [mm]	Upínací rozsah [mm]
NPT 3/8	BNBC-01	16	15	17	4,0 - 8,0
NPT 1/2	BNBC-02	21	13	22	6,0 - 12,0
NPT 3/4	BNBC-03	29	13	30	13,0 - 18,0

Mosazná matice s metrickým závitem

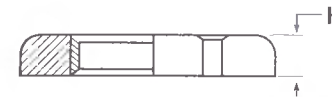

DIN 46320

Technické parametry

Materiál:	Poniklovaná mosaz
------------------	-------------------



Velikost	Označení	H [mm]	⌀ [mm]
M 12	BMBL-01	2,8	15
M 16	BMBL-02	3	19
M 20	BMBL-03	3,5	24
M 25	BMBL-04	4	30
M 32	BMBL-05	5	36
M 40	BMBL-06	5	46
M 50	BMBL-07	5	60
M 63	BMBL-08	5	70

Mosazná matice s Pg závitem

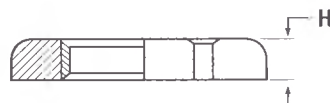

DIN 46320

Technické parametry

Materiál: Poniklovaná mosaz



Velikost	Označení	H [mm]	🔑 [mm]
Pg 7	BSL-01	2,8	15
Pg 9	BSL-02	2,8	18
Pg 11	BSL-03	3	21
Pg 13,5	BSL-04	3	23
Pg 16	BSL-05	3	26
Pg 21	BSL-06	3,5	32
Pg 29	BSL-07	4	41
Pg 36	BSL-08	5	51
Pg 42	BSL-09	5	60
Pg 48	BSL-10	5,5	64

Mosazná matice pro vývodky na stíněné kabely s metrickým závitem

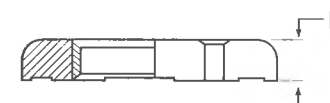

Technické parametry

Materiál: Poniklovaná mosaz



Velikost	Označení	H [mm]	🔑 [mm]
M 12	BMEL-01	4,7	15
M 16	BMEL-02	4,7	19
M 20	BMEL-03	4,7	24
M 25	BMEL-04	5,2	30
M 32	BMEL-05	6,7	36
M 40	BMEL-06	6,7	46
M 50	BMEL-07	6,7	60

Mosazná matice pro vývodky na stíněné kabely s Pg závitem

Technické parametry

Materiál: Poniklovaná mosaz

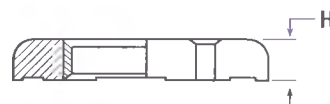

Velikost	Označení	H [mm]	Ø [mm]
Pg 7	BSEL-01	4,7	15
Pg 9	BSEL-02	4,7	18
Pg 11	BSEL-03	4,7	21
Pg 13,5	BSEL-04	4,7	23
Pg 16	BSEL-05	4,7	26
Pg 21	BSEL-06	5,2	32
Pg 29	BSEL-07	5,7	41
Pg 36	BSEL-08	6,7	51

Montážní vývodky

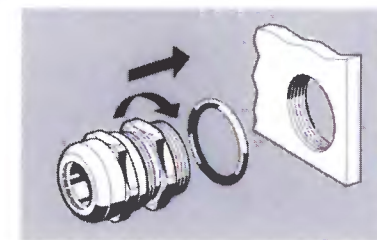
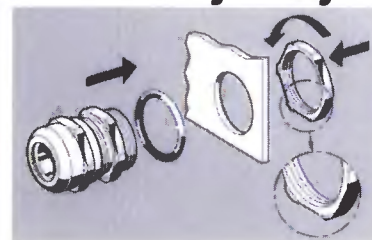

Odstranění izolace vodiče

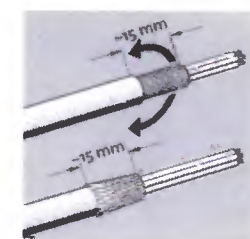
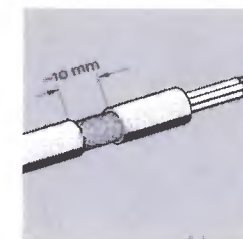
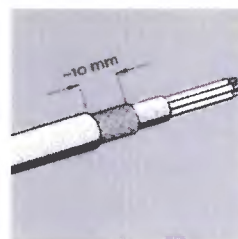

Uchycení vodiče do vývodky

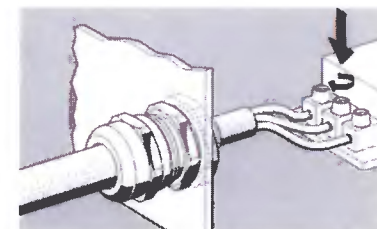
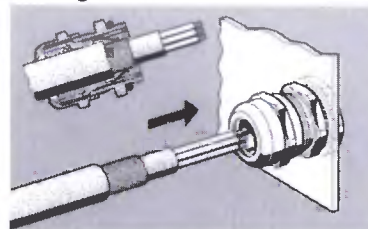

Dotážení vývodky

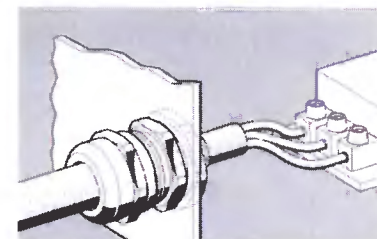
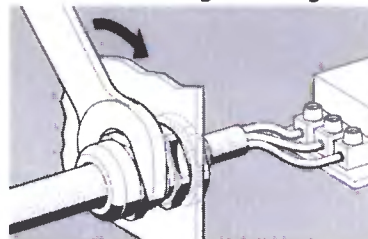

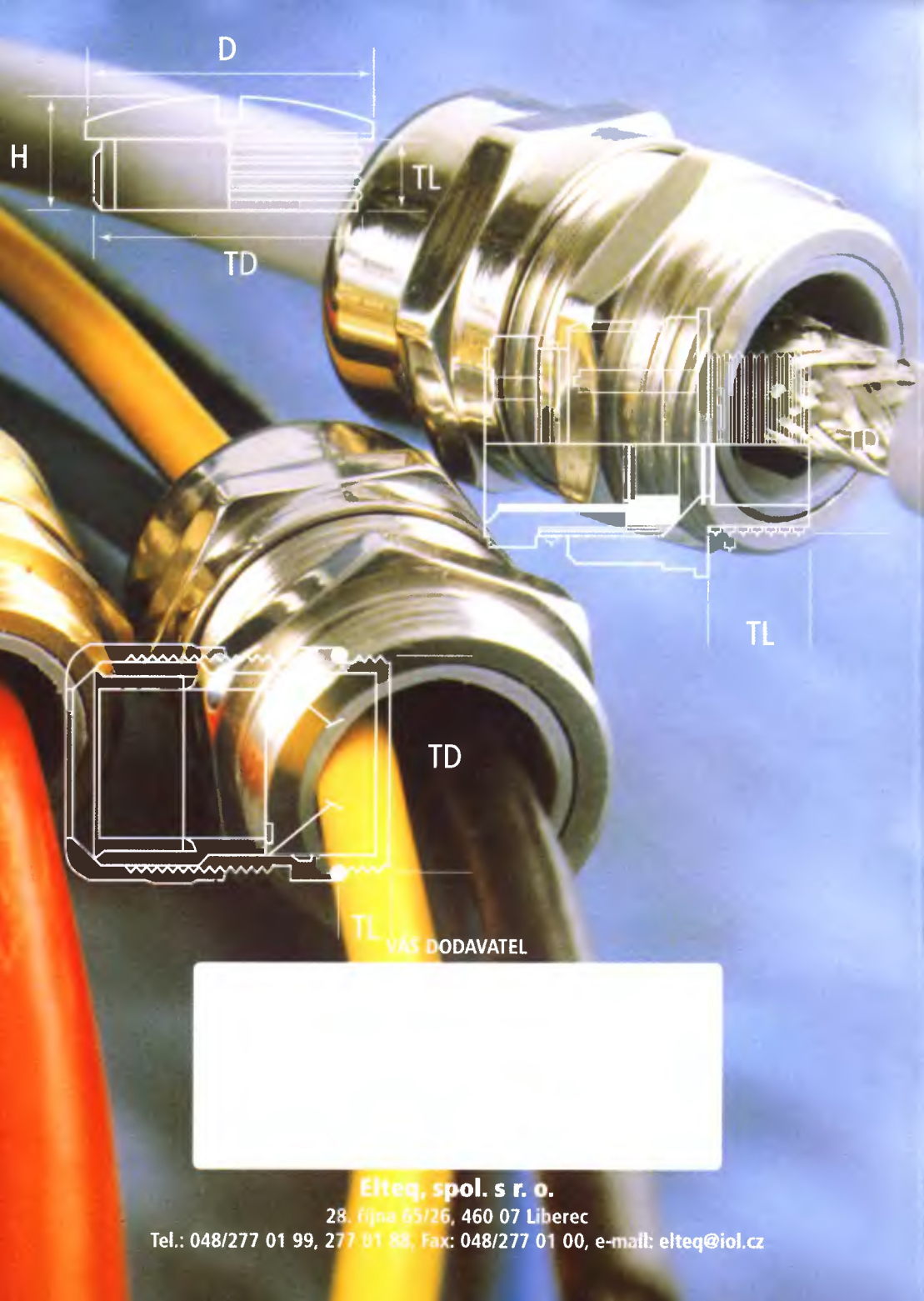

D

H

TL

TD

TL

TD

TL

VÁS DODAVATEL

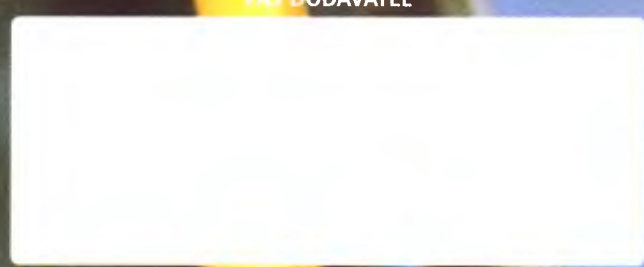

Elteq, spol. s r. o.

28. října 65/26, 460 07 Liberec

Tel.: 048/277 01 99, 277 01 88, Fax: 048/277 01 00, e-mail: elteq@iol.cz